

PM135 Quick Start Manual

This quick start manual is a short guide on how to mount, connect, configure and operate the PM135. It is not intended to replace reading the full user manual and particularly the safety precautions.



Mounting, electrical connection and settings of the PM135 shall be made in accordance with all applicable laws and/or regulations and be performed by authorized personnel only.

MOUNTING

Position the PM135 meter in 92×92mm square or 4" round cutout (Figure 1). If two PM135 are positioned side by side, keep at least 150mm (5.9") between their centers to allow installation of add-on modules (140mm/5.5" if only small form modules will be used).

Attach the PM135 unit using washers and nuts. Make sure that the unit is securely attached into the wall or cabinet fixture.

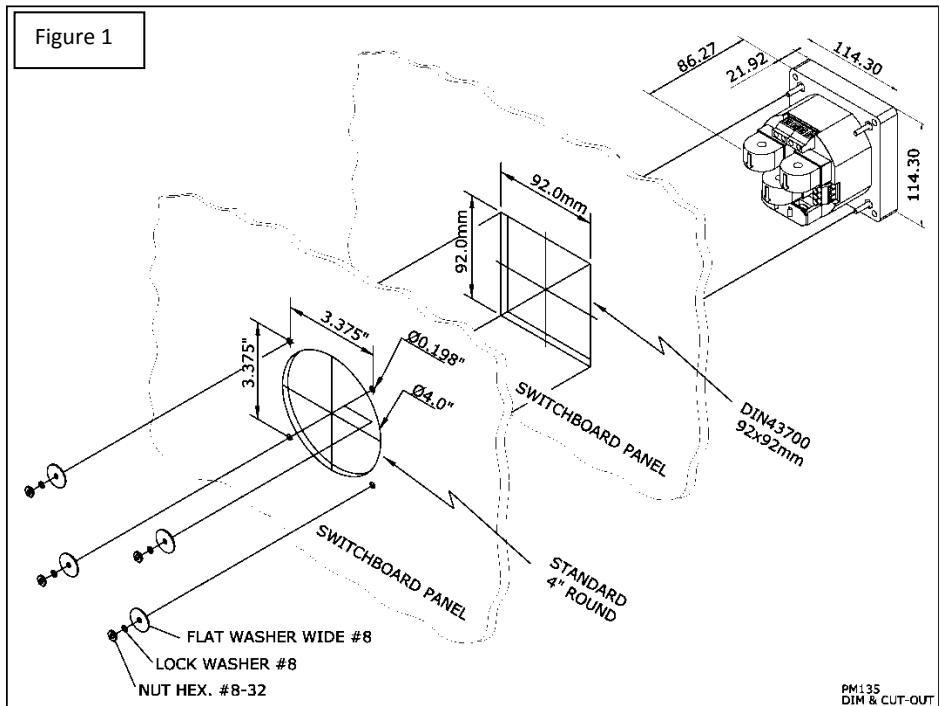

CONNECTION

To connect follow these steps (Figure 2 shows a 4W LV installation with conventional CTs):

1. Ensure that all incoming power sources are OFF.
2. Check that you have the appropriate power supply.
3. Connect the Power Supply inputs using 1.5 mm²/14AWG dedicated wires and breaker.
4. Connect to the external CTs by passing the external CTs wires through the meter CT cores. Observe the arrow that indicates the current direction (Figure 2A). For HACS: connect the red or white wire to the “-” and orange or black wire to the “+” terminal.
5. In case of a retrofit application where each external CT ends with two wires (Note 2B):
 - 5.1. Pass one wire through the meter CT core.
 - 5.2. Connect the wire to one of the meter “optional CT wire termination” screws.
 - 5.3. Connect the second wire from the external CT to the termination screw.
6. Connect the measured voltage inputs
7. Connect COM1 – RS-485 communication port
8. To connect the optional module:
 - 8.1. Make sure that the power is turned off
 - 8.2. Remove the module cover
 - 8.3. Attach the module and fasten the screws
 - 8.4. Connect the module I/O or communication (see Figure 2C for DI/O wiring)
9. Turn the power up
10. Make sure the diagnostic led is off and solid “123” phase indication is displayed

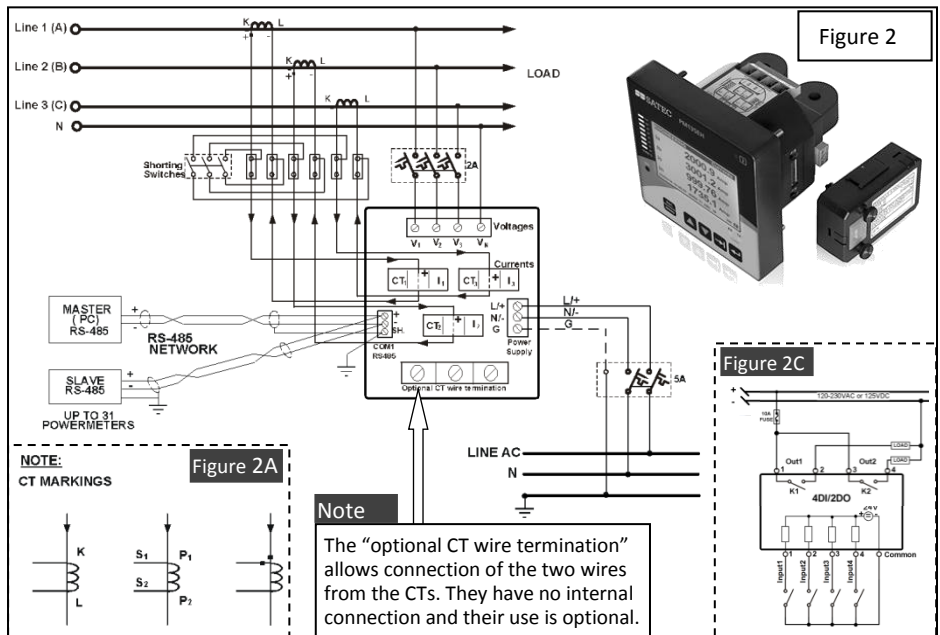

OPERATION

The PM135 is operated using the front panel which consists of an LCD display, 12 LEDs and five keys as shown below:

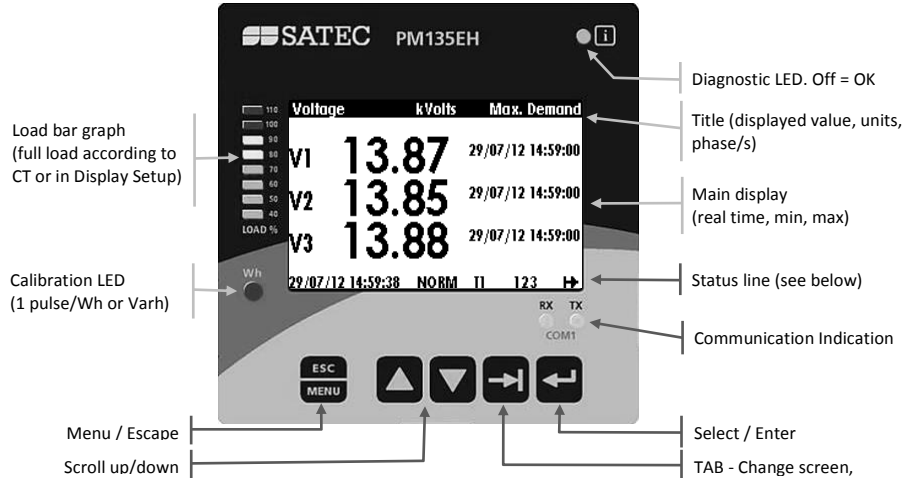

Status Line

Date, time, operation mode, current tariff (T1÷T8), phase indicators and power flow direction.

Operation modes: NORM and TEST. In the TEST mode the energy registers are not accumulated and the calibration led is 10 times faster (10 pulses per Wh or varh).

Phase indication is on when voltage is ok, blinking when below voltage dip set value or marked as “-” when below the interruption set value.

Power flow direction: Normal flow (generation to load) – →, reverse flow – ← or no load – ✕

Display Screens

Group (→ to change)	Screens (▲ to go right, ▼ to go left). Underlined = included in Auto Scroll
Voltages	<u>V L-L</u> // <u>V L-N</u> // THD // Ue // <u>H_z</u> // Phase // Demand
Currents	<u>Amps</u> // THD // TDD // K Factor // Unbalance // Demand
Powers	<u>Total</u> // <u>L1</u> // <u>L2</u> // <u>L3</u> // Import Demand // Export Demand
Demands	P Import // P Export // Amps // Volts
Min/Max	V L-L // V L-N // Amps // I neutral // P // PF // Hz
Energy	Import // Export
TOU (Import, Export)	Reg#1 // Reg#2
Harmonics	#3 // #5 // #7 ... #39
Spectrum	V1 // V2 // V3 // I1 // I2 // I3
Waveform	L1 // L2 // L3
Phasor	
Digital I/O	
Diagnostic	
Alarms	
Basic Settings	Page1 // Page2
Device Info	Info // Com

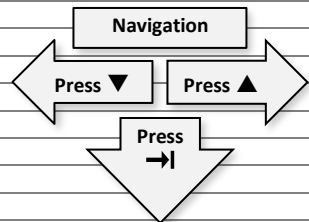

CONFIGURATION

The essential configuration includes:

1. Basic measurement setup
2. Communication setup and testing
3. Resetting the min/max, energy, demands etc.

Additional recommended configuration: set points, TOU and data logging

Note: It may be easier to configure communication first and use PAS software for setup

Basic Measurement Setup





In any display screen, press **MENU**       to enter the Basic Settings Display.

Parameter	Description	Default
Wiring Mode (see below)	Network wiring configuration	4LN3
PT Ratio	Transformation ratio of the Potential Transformers	1
PT Ratio Multiplier	Additional PT factor for EHV network	X1
CT Primary Current	The Primary Rating Of The Current Transformers	5A
Power Demand Period (E & EH models)	Duration in minutes of the power demand period calculations. E = External pulse in DI1.	15
Blocks in Sliding Demand (E & EH models)	The number of blocks to be averaged for sliding window demands	1
Volt/Ampere Demand Period	Duration in seconds for voltage and current demand	900
Nominal Frequency	The nominal frequency	60 Hz
Max. Demand Load Current	0 = CT primary current. Other = max. current	0





Wiring Mode	Setup
3-wire 2-element Delta direct connection using 2 CTs	3DIR2
4-wire 3-element Wye direct connection or 3PTs, and 3 CTs	4LN3 or 4LL3*
3-wire 2-element Open Delta connection using 2 PTs, 2 CTs	3OP2
4-wire 2½-element Wye connection using 2 PTs, 3 CTs	3LN3 or 3LL3*
3-wire 2½-element Open Delta connection using 2 PTs, 3 CTs	3OP3
4-wire 3-element Delta direct connection using 3 CTs	4LN3 or 4LL3*
3-wire 2½-element Broken Delta connection using 2 PTs, 3 CTs	3bLN3 or 3bLL3*

* LN or LL denotes the default use of L-L or L-N voltages (in thresholds, min/max, demands etc.)

Communication setup and testing

In any display screen, press **MENU**   5 times  and  to setup the built in RS-485 port (COM1). If communication module is present, configure also COM2.

Resetting the min/max, energy, demands etc.

Press **MENU**    to enter the reset menu. Select the value to be reset, press  to select, then press  for 5 seconds until the "Do" notification is changed to "Done".

WIN!

For a Chance to Win a Tablet Register Your Product Here:

www.satec-global.com/register