



EM235/PM335 PRO

Advanced Power meter

Installation and Operation Manual



BG0612 Rev. A3

LIMITED WARRANTY

The manufacturer offers the customer functional warranty for 36 months from the date of production. This warranty is on a return to factory basis.

The manufacturer does not accept liability for any damage caused by instrument malfunction. The manufacturer accepts no responsibility for the suitability of the instrument to the application for which it was purchased.

Failure to install, set up or operate the instrument according to the instructions herein will void the warranty.

Only a duly authorized representative of the manufacturer may open your instrument. The unit should only be opened in a fully anti-static environment. Failure to do so may damage the electronic components and will void the warranty.

The greatest care has been taken to manufacture and calibrate your instrument. However, these instructions do not cover all possible contingencies that may arise during installation, operation or maintenance, and all details and variations of this equipment are not covered by these instructions.

For additional information regarding installation, operation or maintenance of this instrument, contact the manufacturer or your local representative or distributor.

For more details concerning technical assistance & support visit manufacturer's web site:

www.satec-global.com

All trademarks are property of their respective owners.

August 2021

Copyright 2020-2022 © SATEC Ltd.

WARNING

Read the instructions in this manual before performing installation and take note of the following precautions:

➤ Ensure that all incoming AC power and other power sources are turned OFF before performing any work on the instrument. Protect the measurement AC Inputs voltage (V1, V2, V3) with 2A external overcurrent protection device and the power supply source inputs with 5A external overcurrent protection device, located close to the equipment

➤ PM335 PRO is intended for measurements performed in building and industrial installations, relating to measurement category III (UL61010-1 3rd ed.), pollution degree 2.

➤ The secondary of an external current transformer must never be allowed to be open circuit when the primary is energized. An open circuit can cause high voltages, possibly resulting in equipment damage, fire and even serious or fatal injury. Ensure that the current transformer wiring is secured using an external strain relief to reduce mechanical strain on the screw terminals, if necessary. Use the Listed Energy-Monitoring Current Transformers.



➤ Always open or disconnect circuit from power-distribution system (or service) of building before installing or servicing current transformers.

➤ Secure current transformer and route conductors so that they do not directly contact live terminals or bus.

➤ Ensure that all incoming AC power and other power sources are turned OFF before performing any work on the instrument. Failure to do so may result in serious or even fatal injury and/or equipment damage.

➤ Before connecting the instrument to the power source, check the labels at the front of the instrument to ensure that your instrument is equipped with the appropriate rating input voltages and currents.

➤ Under no circumstances should the instrument be connected to a power source if it is damaged.

➤ Any use or operations not specified by this manual may cause a protection impairment to the device.

➤ To prevent potential fire or shock hazard, do not expose the instrument to rain or moisture.

➤ While installing HACS to the secondary of an external third party current transformer, the external current transformer secondary output must never be allowed to be open circuit when the primary is energized. An open circuit can cause high voltages, possibly resulting in equipment damage, fire and even serious or fatal injury. Ensure that the current transformer wiring is secured using an external strain relief to reduce mechanical strain on the screw terminals, if necessary.

➤ Only qualified personnel familiar with the instrument and its associated electrical equipment must perform setup procedures.

➤ Do not open the instrument under any circumstances when it is connected to a power source.

➤ Do not use the instrument for primary protection functions where failure of the device can cause fire, injury or death. The instrument can only be used for secondary protection if needed.

➤ This equipment does not require cleaning for proper operation

➤ This equipment is not intended to be directly connected to medium and high voltage power lines, only using Listed Energy-Monitoring Current & Voltage Transformers, certified for this purpose.

Read this manual thoroughly before connecting the device to the current carrying circuits. During operation of the device, hazardous voltages are present on input terminals. Failure to observe precautions can result in serious or even fatal injury or damage to equipment.

Table of Contents

Chapter 1 General Information	9
Features	9
Voltage Measurement Inputs	10
Current Measurement Input Options	10
Communications Interfaces	11
Optional Built-in Digital and Analog I/O	11
Optional Expansion Add-on Modules	11
Displays options.....	12
Upgradeable Firmware	12
Meter Security	13
Supplemental Documents	15
Measured Parameters	16
Chapter 2 Installation.....	18
Site Requirements	18
Package Contents.....	18
Mechanical Installation.....	18
PM335 PRO Dimensions	18
EM235 PRO Dimensions	19
PM335 Pro preparation for Panel Mount	20
Panel Mounting	20
RPM335 DIN Rail Mounting.....	22
Module mounting	23
Electrical Installation	24
Typical Installation	25
Connecting the wires	27
Terminals.....	28
Power Source Connection.....	28
Voltage Input connection	29
Current Input Connection.....	29
Wiring Diagrams	30
DC voltage measurement	33
DC current measurement (hall effect sensors).....	35
DC setup.....	37
DC setup is defined through PAS or through the meter basic setup menu.....	37
Setup menu	37
Nominal freq section in the basic setup enables choosing DC.	37
PAS menu	38
I/O Connections	38
Built-in I/O connections	38
I/O module installation and connection	39
External Modules connection to Pro	39
8 DI Module.....	40
4RO Module.....	41
AUX_PS Module	42
Communications Connections	43
COM1 RS-485 Connection	44
Ethernet Connection	45
USB connection.....	49

Chapter 3	Operating the EM235/PM335 PRO	50
	Control and Indicators	50
	Device Controls	50
	Indicator LEDs	50
	Modes of Operation	50
	Operational Mode	50
	Energy Test Mode.....	50
	Service Mode.....	50
	Diagnostics Mode	50
	Communicating with the EM235/PM335 PRO	51
	COM1-COM4 Serial Communications (standard).....	51
	USB Port (standard).....	51
	Ethernet Port	51
	Using PAS	52
	Device Inputs	53
	AC Inputs	53
	Digital Inputs	53
	Analog Inputs.....	53
	Device Outputs.....	54
	Analog Inputs/Outputs (future release).....	54
	Relay Outputs	54
	Metering	55
	RMS Measurements	55
	RMS Trace	55
	Harmonic Measurements	56
	Aggregation Intervals.....	57
	Demands	57
	Energy Metering	58
	Instrument Transformer Correction	59
	Monitoring	59
	Memory Backup Battery	59
	Logical Controller	59
	Recording.....	60
	Event Recorder	60
	Power Quality Recorder	60
	Device Diagnostics	60
	Meter Security	61
	Configuring Meter Passwords.....	61
Chapter 4	Using Front Display.....	63
	Display Operations.....	64
	Navigation Buttons	64
	Display Menus	65
	Navigating using Display	65
	Display Features.....	67
	TEST Mode Data Display	68
	Monitor Display	68
	Instrumentation Data Display	68
	Consumption Display	74
	Billing Period Data Displays.....	74
	Power Quality Display	76
	RT Waveform Display	76
	Harmonics Display	76
	Phasor Display	77

Trend Display.....	77
Load Bar Graph	77
Energy Pulse LED.....	77
Logs and Diagnostics display	79
Alarms/Event log.....	79
Diagnostics	79
Device Setup.....	79
Entering the Password	80
Viewing and Changing Setup Options	80
Chapter 5 Using PAS Software	81
Installing PAS.....	81
Creating a New Site for your Meter.....	82
Setting up Communications	83
Communicating through a Serial Port	83
Communicating through the Internet	84
Setting Up the Meter	85
Preparing Setups for the Meter	85
Downloading Setups to the Meter	86
Uploading Setups from the Meter.....	86
Authorization	87
Upgrading Device Firmware	87
Chapter 6 Configuring the EM235/PM335 PRO	89
Configuring Communications.....	89
Setting Up Serial Communication Ports.....	89
Setting Up Ethernet.....	91
Setting Up RSTP in Daisy Chain mode	93
Setting-Up SNTP Client	94
Configuring eXpertPower Client.....	96
Setting Up TCP Notification Client.....	97
General Meter Setup.....	98
Basic Meter Setup	98
Device Options.....	100
Transformer Correction	103
Configuring Digital Inputs	104
Configuring Relay Outputs	106
Configuring Analog Inputs.....	108
Configuring Analog Outputs (future)	108
Using Counters	111
Using Periodic Timers.....	111
Using Control Setpoints.....	113
Display Setup	116
Custom Name ID	116
Adjusting the display	117
Updating the meter Clock	117
Local Time Settings	119
Resolution setting.....	122
Chapter 7 Configuring Recorders	123
Configuring Device Memory.....	123
Configuring the Event Recorder.....	127
Configuring the Data Recorder	127
Conventional Data Log Files	127
Factory Preset Periodic Data Logs	129
Factory Preset Fault and PQ Data Logs	129

TOU Profile Data Log Files.....	129
Configuring the Waveform Recorder	130
Configuring the Power Quality Recorder	132
Chapter 8 Totalization Energy and TOU Registers	136
Configuring Summary and Bill./TOU Reg.	136
Configuring TOU Daily Profiles	138
Configuring TOU Calendar	139
Chapter 9 Configuring Communication Protocols	141
Configuring Modbus	141
Modbus Point Mapping	141
Changing 32-bit Register Format	141
Configuring DNP3	142
DNP Options	142
Configuring DNP Class 0 Responses	143
Configuring IEC 60870-5	145
Configuring IEC 60870-5 Options.....	145
Remapping Point Addresses and Event Reporting	148
Configuring Class 2 Data and Counter Transmission.....	149
Configuring IEC 61850.....	150
Licensing IEC 61850.....	150
Configuring IED Properties.....	151
Configuring Datasets.....	152
Configuring Report Control Blocks	152
Configuring the GOOSE Publisher	153
Configuring the GOOSE Subscriber.....	154
Chapter 10 Device Control.....	158
Remote Relay Control.....	158
Device Event Flags	159
Viewing and Clearing Device Diagnostics	160
Viewing Communication Status and Statistics.....	161
Resetting Accumulators and Clearing Log Files.....	162
Chapter 11 Monitoring Meters	165
Viewing Real-time Data	165
Organizing Data Sets	165
Polling Devices.....	165
Viewing a Data Table	166
Viewing Data Trend	167
Saving Data to a File	168
Printing Data.....	168
Copying Data.....	168
Real-time Data Logging	168
Viewing Real-time Min/Max Log	169
Viewing Real-time Waveforms.....	169
Viewing Real-time Min/Max Log	169
Viewing Real-time Waveforms.....	169
Viewing Real-time Harmonic Spectrum	172
Chapter 12 Retrieving and Storing Files	175
Uploading Files on Demand	175
Using the Upload Scheduler	176
Chapter 13 Viewing Files On-line	178
General Operations.....	178
Opening a Log File	178

Copying Data	178
Saving Data to a File	178
Printing Reports	178
Customizing Views	178
Viewing Options	179
Customizing Views	179
Working with Tables	179
Working with Graphic Windows.....	180
Viewing the Event Log	181
Viewing the Power Quality Log	183
Viewing the ITI (CBEMA) Curve.....	185
Viewing the Data Log	185
Viewing Data Trend	185
Viewing Waveforms	186
Viewing an RMS Plot	188
Viewing a Frequency Plot	188
Viewing a Spectrum Chart	188
Viewing a Spectrum Table	189
Waveform Options	189
Viewing Synchronized Waveforms	192
Exporting Files	193
Exporting Files in COMTRADE and PQDIF Formats.....	193
Exporting Files in Excel Format	194
Archiving Files.....	194
Chapter 14 Technical Specifications	196
Environmental Conditions	196
Construction	196
Power Supply Installation Category III.....	196
Input Ratings	196
Optional Relay Outputs	197
Optional Digital Inputs.....	197
Communication Ports	198
Real-time Clock	199
Display.....	199
Standards Compliance	199
Measurement Specifications.....	200
Chapter 15 Analog Output Parameters.....	202
Chapter 16 Setpoint Triggers and Actions	204
Chapter 17 Parameters for Data Monitoring and Logging	207
Chapter 18 Billing/TOU Profile Log File.....	215
Chapter 19 Data Scales	216
Chapter 20 Device Diagnostic Codes	217

Chapter 1 General Information

The PM335/EM235 PRO is a compact, multi-function, three-phase Powermeter especially designed to meet the requirements of users ranging from electrical panel builders to substation operators.

The PRO series consists of three models:

- RPM035 PRO: without display for DIN rail mount, a basic model offers standard voltage, current, power, frequency with Power Quality analysis capabilities and energy measurements, data logging and control capabilities
- PM330 PRO: offers all PM335 PRO features with 7segment super bright LED display (*future release*)
- PM335 PRO: offers all RPM035 PRO features with 3.5' TFT color display
- EM235 PRO: offers all PM335 features in DIN35 form factor with 1.77' TFT display



Features

The compact PRO Series meter is available as the PM335 panel mount (4-inch round / 92x92mm square cutouts) form factor design and the EM235 DIN-rail form factor design. This series combines metering and control in one device, providing the ultimate solution for substation / industrial automation and commercial energy management.

The PRO meters combine and bundle in one physical IED multiple features which ordinarily would be found in several different pieces of equipment.

Primarily designed for integration in the substation substation, it is well suited for a wide range of industrial applications, over a wide range of input currents whenever extensive power monitoring is required.

The EM235/PM335 PRO series combins in a single compound device:

- Up to 26 external inputs, triggered by external sources; onboard zero-sequence currents and volts, current and voltage unbalance; coincident volt magnitude, fault waveforms and fast RMS trace; cross triggering between multiple devices via digital inputs for synchronous event capture and recording.
- Event recorder for logging internal diagnostics events, control events and I/O operations.
- Eight Fast Waveform recorders: 8-channel simultaneous recording; selectable AC sampling rate of 32, 64, 128 or 256 samples per cycle; 20 pre-fault cycles; synchronized waveforms from multiple devices in a single plot; exporting waveforms in COMTRADE and PQDIF file formats (via PAS software).

- Thirteen Fast Data recorders: 1/2-cycle to 2-hour RMS envelopes; programmable data logs on a periodic basis and on any internal and external trigger; triggering from PQ recorder or control setpoints; exporting data trends in PQDIF file format (PAS).
- Three Special Data Recorders with fixed parameters: TOU Monthly Profile data log & TOU Daily Profile data log. These data logs are read only.
- Embedded Programmable Controller: 64 control setpoints, OR/AND logic, extensive triggers, programmable thresholds and delays, relay control, event-driven data recording, cross triggering between multiple devices via ethernet for synchronous event capture and recording – up to sixteen triggering channels.
- High-Class 3-phase Power meter: true RMS, volts, amps, powers, power factors, unbalance, and neutral current.
- Class 0.2S IEC per 62053-22 / Class 0.2 per ANSI C12.20; four-quadrant active and reactive energy polyphase static meter
 - Demand Meter: amps, volts, harmonic demands.
- Precise Energy and Power Demand Meter: Time-of-Use (TOU), 16 Summary (totalization) and TOU energy and demand registers for substation energy management; accumulation of energy pulses from external watt-meters; block and sliding demands; up to 64 energy sources.
- Harmonic Analyzer: up to the 63rd harmonic volts and amps; directional power harmonics and power factor; phasor, symmetrical components.
- 32 digital counters for counting pulses from external sources and internal events.
- 16 programmable timers from 1/2 cycle to 24 hours for periodic recording and triggering operations on a time basis.
 - 1-ms satellite-synchronized clock
 - Network time synchronization (SNTP)
 - Backup/AUX power supply unit.
 - 3 slots for plug-in I/O / COM modules.
- TCP notification client for communicating with a remote MODBUS/TCP server on events or periodically on a time basis, with any IP enable communication port
- 16GB Memory for long-term waveform and data recording.
- Real Time Clock: Internal clock with backup battery for five years Real-Time Clock retention time

Voltage Measurement Inputs

The EM235/PM335 PRO series features 3 fully isolated voltage inputs:

- Rating: 10-1000 V AC L-L @ 50/60 Hz / 10-820 V DC)
- Possibility to connect up to 3000 VDC via special accessory.

Current Measurement Input Options

- 3 input currents for 3P system monitoring (optional 4th channel) via numerous options:
 - 1A rating: for standard CT secondary
 - 5A rating: for standard CT secondary
 - 20mA inputs designated for:

- SATEC HACS CTs (High Accuracy Current Sensors)
- Hall Effect Sensors for DC current
- Flex Clamp: 200A/2V, 30A-300A-3000A/37 Rogowski coil

Communications Interfaces

Built-in communication ports

- One serial communications port; RS-485, up to 115,200 bps, supporting MODBUS RTU/ASCII, DNP3.0 and IEC 60870-5-101 protocols
- Infrared port; up to 19200 bps, supporting MODBUS RTU/ASCII, DNP3.0 protocols and IEC 62056-21
- 2 Built-in ethernet 10/100Base-T ports (dual port ethernet) supporting MODBUS/TCP, DNP3.0/TCP, IEC 60870-5-104 protocols and IEC 61850 Ed2 protocol, up to 10 non-intrusive simultaneous connections per ethernet port (2 reserved for Expert power communication)
- Daisy chain capability with RSTP support or 2 independent Ethernet port. The Meter supports as default 20 chained connected devices
- USB 2.0 port (type C), supporting MODBUS RTU protocol
 - See below

Optional Built-in Digital and Analog I/O

- - DI: 2 optically isolated inputs, 24VDC dry contact; programmable de-bounce time from 1 ms to 1 s; control setpoints, pulse counters and Energy/TOU subsystem, 1pps time synchronization; 1ms sampling rate
 - RO: 1 Solid State Relay output; unlatched, latched and pulse operations, failsafe operation for alarm notifications; programmable pulse width; direct remote relay control through communications
 - AI: 1 optically isolated analog input; -1mA to 20mA

Optional Expansion Add-on Modules

Combining up to 4 different expansion modules side by side

- Up to 2 expansion modules: self-energized
- 3 expansion modules: requires additional module of AUX power supply
- Of which maximum can be two CI modules, per device
- Of which maximum can be one VI module, per device

Digital I/O modules

- 8 DI: 8 optically isolated inputs per module; options for:
 - dry contacts
 - 24V, 48V, 125V, 250V wet inputs;
 programmable de-bounce time from 1 ms to 1 sec; control setpoints, pulse counters and Energy/TOU subsystem, 1pps time synchronization; 1ms sampling rate.
- 4RO: 4 relay outputs per module, Electro-Mechanic (EMR), or Solid State (SSR) relay option; unlatched, latched and pulse operations, failsafe operation for alarm notifications; programmable pulse width; direct remote relay control

through communications

Auxiliary Power supply Module

- Rating: 88-264 V AC / 125-300 V DC
 - 50/60 Hz
- Note: This module should be the last one assembled in the chain of connected modules
 - Extra Current Channels Module
- 6 CI (*future release*): 6 two sets of 3P 20mA current inputs compatible with HACS CTs (AC current) secondary outputs and Hall Effect sensor (DC current) output
- 3 VI (*future release*): 3 high impedance voltage inputs with one common wire (for example 4LN3).

Displays options

The EM235/PM335 PRO SERIES can be ordered with a super bright LED Remote Display Module (PM330 PRO) or an LCD Graphical Module (PM335/EM235).

PM335 PRO

The PM335 PRO is equipped with a 3.5' TFT color graphics LCD display with extensive dialog capabilities, allowing the user to view different fault and power quality information in a graphical form, such as waveforms, harmonic spectrum, phasors and data trends, review latest fault and power quality reports for fast fault analysis, and much more, using five buttons.

In addition the PM335 PRO is equipped with two communication ports: USB and IR, for monitoring and configuration, green led for CPU OK and red led for energy led pulse rate in test mode. Three-color load bar LED.

PM235 PRO

The PM235 PRO is equipped with a 1.77' TFT color graphics LCD display with extensive dialog capabilities, allowing the user to view different fault and power quality information in a graphical form, such as waveforms, harmonic spectrum, phasors and data trends, review latest fault and power quality reports for fast fault analysis, and much more, using four buttons.

In addition the PM235 PRO is equipped with two communication ports: USB and IR, for monitoring and configuration, green led for CPU OK and red led for energy led pulse rate in test mode.

Upgradeable Firmware

The EM235/PM335 PRO SERIES uses mass storage memory for storing device firmware. This allows upgrading of your device without replacing hardware components. New features can be easily added to your device by simply replacing firmware through any communication port.

The firmware name is built of four different fields to define the version as described below:

EM235: V40.XY.ZZ.zz

PM335: V44.XY.ZZ.zz

Where:

- X represents new features set version - current version is 0 (none)
- Y represents metrology version¹ - current version is 1
- ZZ represents minor version, this version number is incremented after each release - current version is 3
- zz represents build version, last firmware compilation version - current version is 20.

¹ Metrology version is not affected by any of other fields version – features set, minor and build versions

Meter Security

The EM235/PM335 PRO SERIES provides 3-level password security for protecting meter setups and accumulated data from unauthorized changes. Meter readings are not software protected.

Access to particular setup and control items is granted depending on the security level of the password you entered. The passwords can be 1 to 8 digits long.

The EM235/PM335 PRO SERIES is also equipped with terminal connections sealed cover to avoid unwanted electrical connections.

Table 1: Security Level and User access

Password	Security level	Access rights
Password 1	Low	Reset of billing and engineering maximum demands, and device diagnostics. Meter clock update. Display setup.
Password 2	Medium	TEST mode. Reset of counters and pulse counters. Communications setup. I/O operation setup and control. Memory and recorders setup. Billing/TOU system setup.
Password 3	High (Administration level)	Meter passwords setup. Basic device setup. Device energy and power options setup. Reset of conventional log files.

Password Security

The setup menus are secured by 8-digit user passwords. Every time you enter programming mode, you are prompted for a correct password. The meter is primarily shipped with all passwords preset to "9" at the factory. See [Meter Security](#) in Chapter 2 for more information on the meter security levels.

It is recommended that you change the factory set passwords as fast as possible to protect your setups and accumulated data from unauthorized changes. See [Configuring Meter Passwords](#) in Chapter 5 on how to change passwords in your meter.

Enter the password as you enter numeric values. As you move to the next place, the digit entered is saved and then zeroed. If you missed a digit, you should re-type all preceding digits before you reach the missed place again.

Once the password is set to the desired value, press and hold the SELECT/ENTER button for more than 1 second. If the password you entered is correct, you move to the main device menu, otherwise you return back to the data display.

Setup Menus and Access Rights

The EM235/PM335 PRO setup is menu-driven. The meter provides number of menus that allow local accessing a limited number of meter setups and control functions listed in the following table. Access to particular menus is granted depending on the security level of the password you entered.

Menu Label	Menu Function	Security Level	
		View	Change
Reset	Reset of engineering maximum demands, device diagnostics, meter and battery operation time counters and failure counters	N/A	See Note below
RTC Setup	RTC clock setup	Low	Low
Display Setup	Display setup	Low	Low
Test Mode Setup	TEST/NORMAL mode switching and LED pulse rate setup for TEST mode (directly accessible via the TEST button)	Low	Medium
Basic Setup	Basic device setup	Low	High
Options Setup	Device options setup	Low	High
COM1 Setup	COM1 serial port setup	Low	Medium
COM2 Setup	COM2 serial port setup	Low	Medium
COM3 Setup	COM3 serial port setup	Low	Medium
COM4 Setup	COM4 serial port setup	Low	Medium
Network Setup	Ethernet network setup	Low	Medium
Local Setup	Local settings	Low	Medium
Access Setup	Meter passwords setup	High	High
Loader	Launches flash download via a local serial port, local USB port, TCP/IP ethernet ports or GSM (<i>future release</i>)	N/A	Medium
Reset Bill MD	Reset of billing maximum demands (accessible via the DEMAND RESET button)	N/A	Sealed
Master Reset	Reset of the billing data and files (protected by a security jumper)	N/A	Sealed

NOTE

Access to the Reset menu entries is allowed depending on your security level as shown in Section [Reset of Accumulators and Log Files](#) in Chapter 6.

If your security level does not allow access to a menu, it will not be listed in the main menu list, and you will not be able to highlight menu items that you are not allowed to change, but you can still view their present settings.

Supplemental Documents

- BG0613 EM235/PM335 PRO SERIES MODBUS Reference Guide
- BG0614 EM235/PM335 PRO SERIES DNP3 Reference Guide
- BG0615 EM235/PM335 PRO SERIES IEC60870-5 Reference Guide
- BG0619 EM235/PM335 PRO SERIES IEC61850 Reference Guide
 - BG0337 PAS Getting Started Guide

Measured Parameters

Table 2: Measured and Displayed Parameters

Parameter	Display ¹	Comm.	Analog	Pulse	Alarm
1-cycle Real-time Measurements					
RMS Voltage per phase		✓	✓		✓
RMS Current per phase		✓	✓		✓
kW per phase		✓			✓
kvar per phase		✓			✓
kVA per phase		✓			✓
Power Factor per phase		✓			✓
Total kW		✓	✓		✓
Total kvar		✓	✓		✓
Total kVA		✓	✓		✓
Frequency		✓	✓		✓
Neutral Current		✓	✓		✓
Total Power Factor		✓	✓		✓
Voltage & Current unbalance		✓			✓
1-sec Average Measurements					
RMS Voltage per phase	✓	✓	✓		✓
RMS Current per phase	✓	✓	✓		✓
kW per phase	✓	✓			✓
kvar per phase	✓	✓			✓
kVA per phase	✓	✓			✓
Power Factor per phase	✓	✓			✓
Total kW	✓	✓	✓		✓
Total kvar	✓	✓	✓		✓
Total kVA	✓	✓	✓		✓
Total Power Factor	✓	✓	✓		✓
Frequency	✓	✓	✓		✓
Neutral Current	✓	✓	✓		✓
Voltage & Current unbalance	✓	✓			✓
Amps & Volt Demands					
Ampere & Volt Demand per phase	✓	✓			✓
Ampere Maximum Demand per phase	✓	✓			✓
Voltage Maximum Demand per phase	✓	✓			✓
Power Demands					
kW Accumulated Demand Import & Export		✓	✓		✓
kvar Accumulated Demand Import & Export		✓	✓		✓
kVA Accumulated Demand		✓	✓		✓
kW Demand Import & Export		✓			✓
kvar Demand Import & Export		✓			✓
kVA Demand		✓			✓
kW Sliding Demand Import & Export		✓			✓
kvar Sliding Demand Import & Export		✓			✓
kVA Sliding Demand		✓			✓
kW Predicted Demand Import & Export		✓			✓
kvar Predicted Demand Import & Export		✓			✓
kVA Predicted Demand		✓			✓

¹ GDM PRO only

Parameter	Display ¹	Comm.	Analog	Pulse	Alarm
kW Maximum Demand Import	✓	✓			
kW Maximum Demand Export	✓	✓			
kvar Maximum Demand Import	✓	✓			
kvar Maximum Demand Export	✓	✓			
kVA Maximum Demand	✓	✓			
Total Energy					
Total kWh Import & Export	✓	✓		✓	
Total kvarh Import & Export	✓	✓		✓	
Total kvarh Net		✓			
Total kVAh	✓	✓		✓	
Energy per Phase					
kWh Import per phase	✓	✓			
kvarh Import per phase	✓	✓			
kVAh per phase	✓	✓			
TOU Registers					
4 TOU energy registers (kWh and kvarh import & export, kVAh, 4 pulse sources)	✓	✓			
4 TOU maximum demand registers	✓	✓			
8 tariffs, 4 seasons x 4 types of day	✓	✓			✓
Harmonic Measurements					
Voltage THD per phase	✓	✓			✓
Current THD per phase	✓	✓			✓
Current TDD per phase	✓	✓			✓
K-factor per phase	✓	✓			✓
Voltage harmonics per phase up to order 63	✓	✓			
Current harmonics per phase up to order 63	✓	✓			
Voltage harmonic angles up to order 63	✓	✓			
Current harmonic angles up to order 63	✓	✓			
Fundamental Component					
Voltage and Current per phase	✓	✓			
kW, PF per phase	✓	✓			
kvar, KVA per phase	✓	✓			
Total kW, PF	✓	✓			
Total kvar, KVA	✓	✓			
Min/Max Logging					
Min/Max A, V, total kW, kvar, kVA, PF	✓	✓			
Min/Max Frequency, Neutral current	✓	✓			
Phase Rotation	✓	✓			✓
Voltage and Current Phase Angles	✓	✓			
Day and Time	✓	✓			
Pulse Counters	✓	✓			✓
Digital Inputs (optional)	✓	✓			✓
Relay Outputs (optional)	✓	✓			✓
Remote Relay Control (optional)		✓			
Alarm Triggers/Setpoints		✓			✓
Self-diagnostics	✓	✓			

Chapter 2 Installation

This chapter discusses the following types of physical installations for the EM235/PM335 PRO SERIES:

- Mechanical Installation
- Electrical Installation
- I/O Connections
- COM Port Connections.

Site Requirements

- Environmental conditions: as specified in Technical Specifications in Chapter 14
- Electrical requirements: as specified in Technical Specifications in Chapter 14
- See [Technical Specifications](#) in Chapter 14 for more details

Package Contents

The EM235/PM335 PRO SERIES package contains the following items:

- EM235/PM335 PRO SERIES unit
 - Quick Start guide
- Optional accessories (depending on the options ordered, if any)

Mechanical Installation

Refer to the figures provided in this section to properly perform the mechanical installation.

PM335 PRO Dimensions

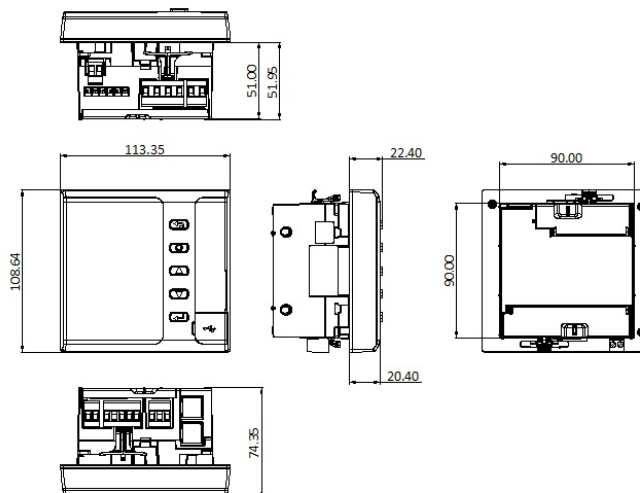

Figure 2-1a PM335 PRO Dimensions

EM235 PRO Dimensions

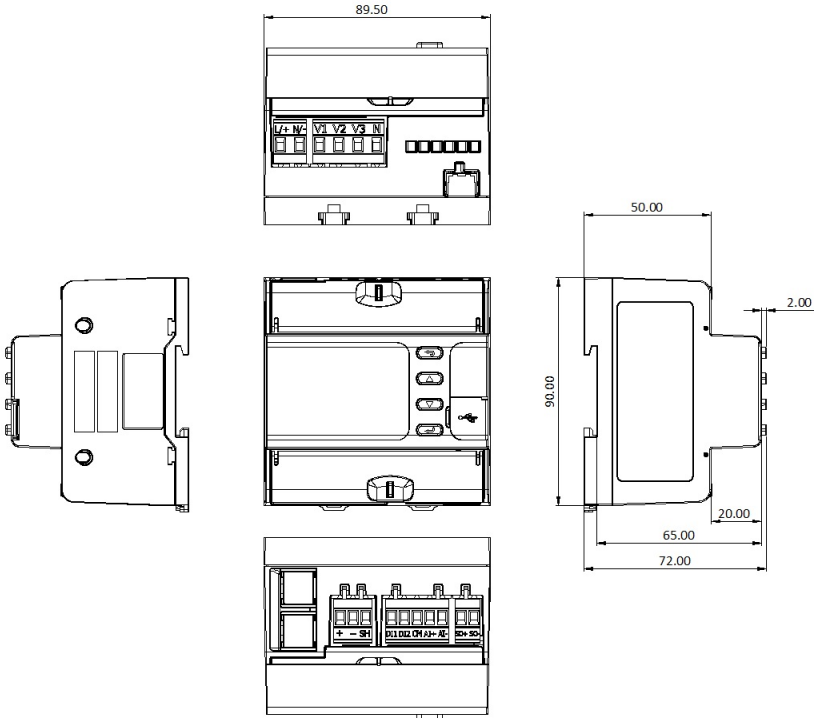
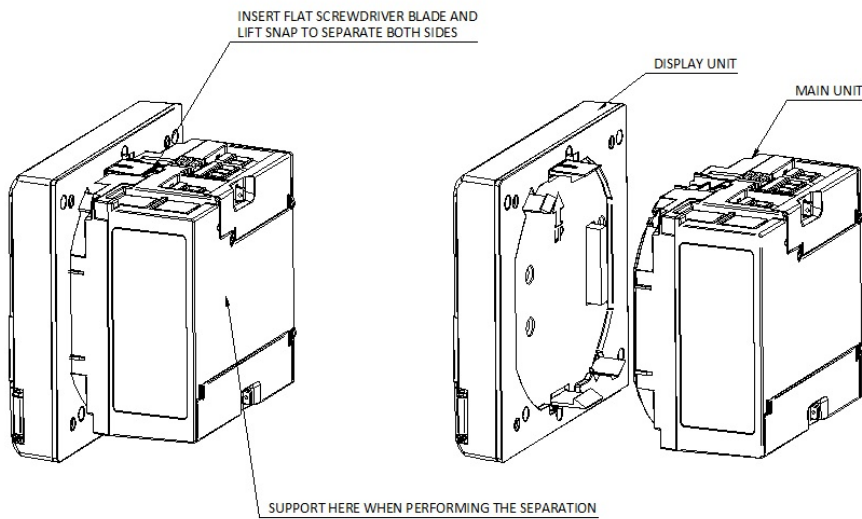

Figure 2-2b EM235 PRO Dimensions

PM335 Pro preparation for Panel Mount.

To mount the instrument on the panel, Separate the Display unit from the main unit as shown in the below drawing.



Panel Mounting

To mount the meter in cutout (ANSI 4" round or DIN 92x92mm square cutout) switchgear panel with width range of 1.0mm (0.04") to 6.4mm (1/4"):

1. Position the Display unit in the Panel cutout.
2. Affix the meter using the 4 screws supplied.
3. Observe orientation !!
4. Snap and connect the main unit to the mounted display unit .
5. Now the instrument is ready for wiring .

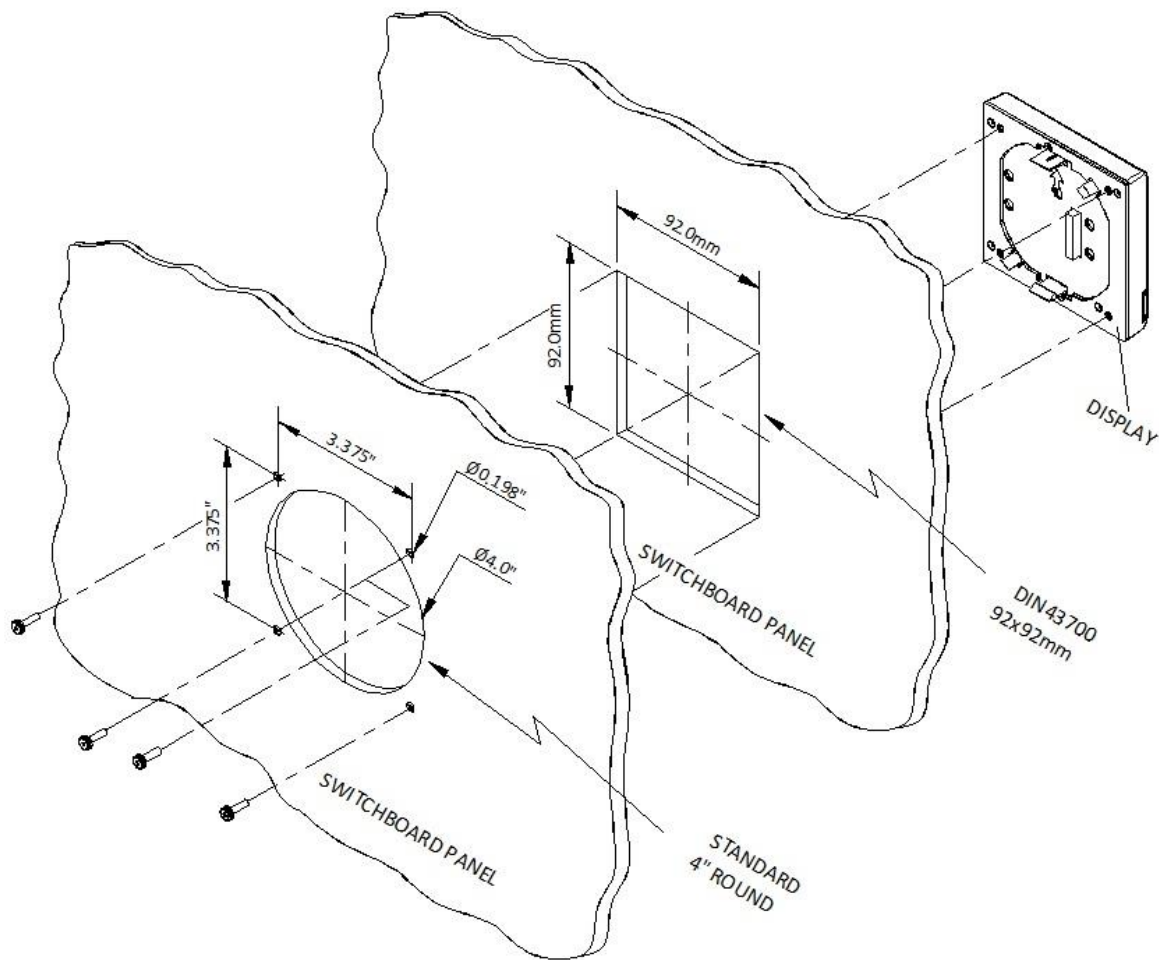

Figure 2-3 Panel Mounting

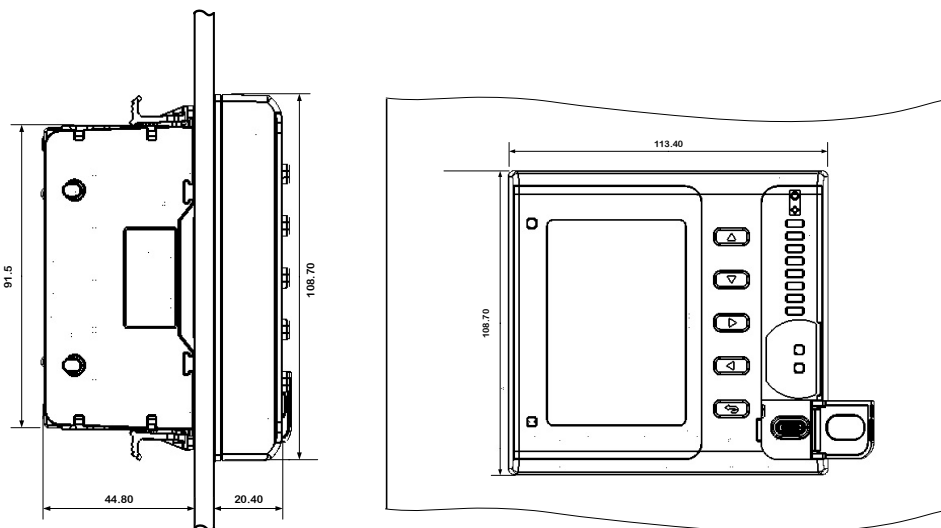

Figure 2-4 PM335 PRO panel mounting dimensions

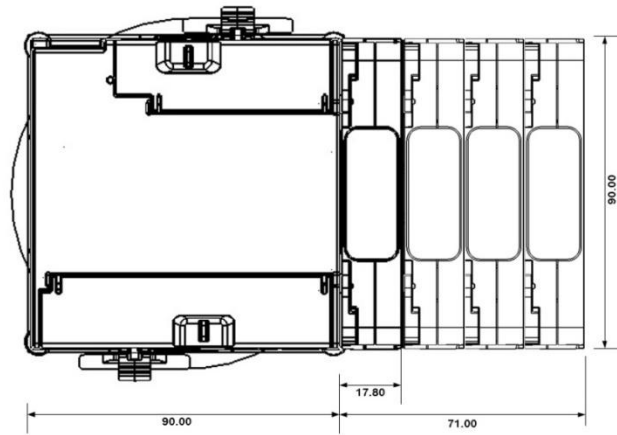

Figure 2-5 PM335 PRO with 4 modules dimensions

RPM335 DIN Rail Mounting

The RPM335 PRO can be mounted on a 35-mm DIN rail.

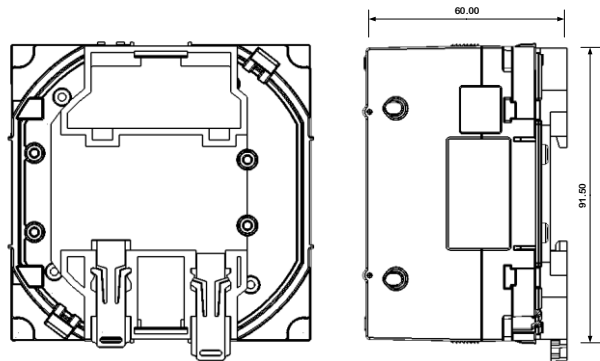

Figure 2-6 RPM335 PRO DIN Rail mounting dimensions

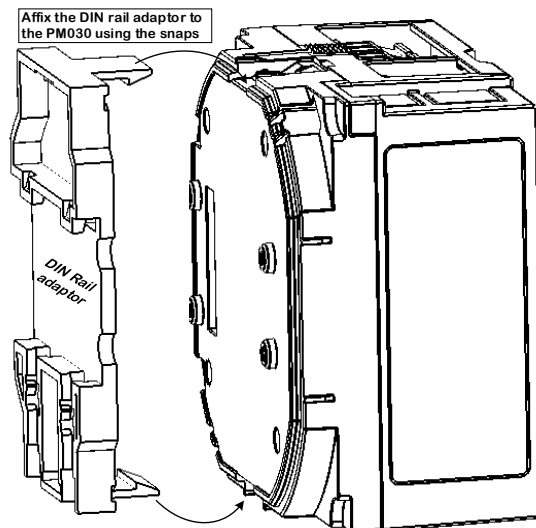
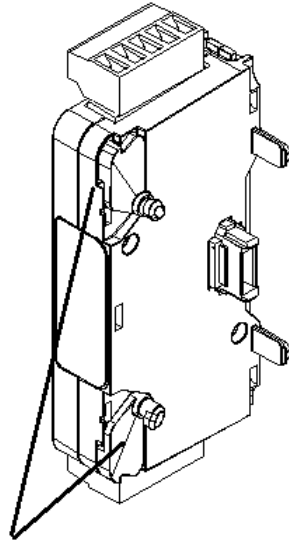

Figure 2-7 DIN Rail adaptor assembling

Module mounting



Ensure that all incoming power sources are shut OFF before installing a module. Failure to observe this practice can result in serious or even fatal injury and damage to equipment.



MODULE LOCK LATCH

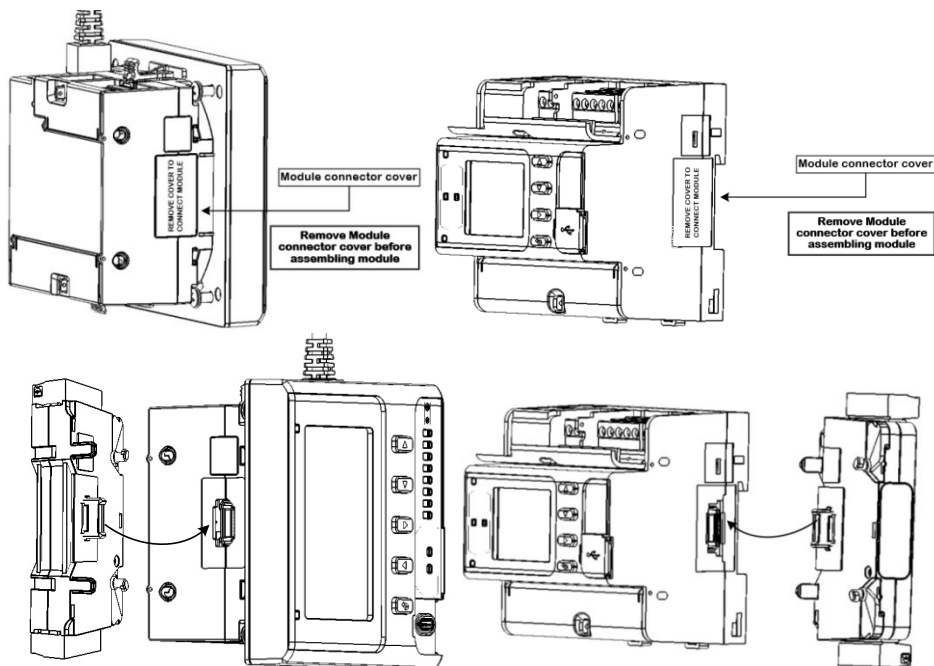

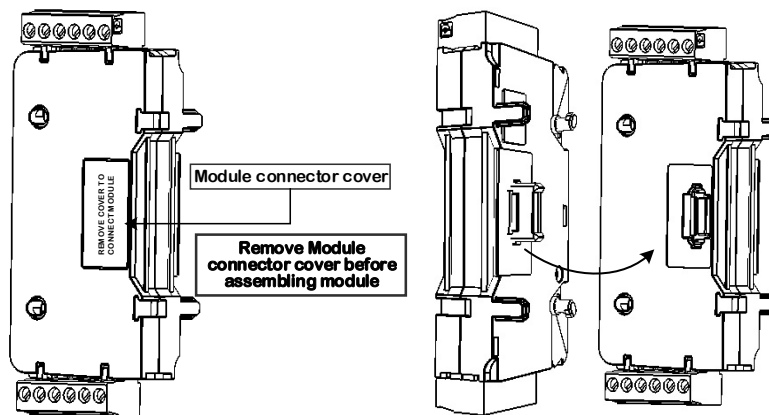

Electrical Installation

Note:

1. The PM335 PRO is mounted on metallic panel which is part of the switchgear, or as EM235 on DIN rail inside the switchgear, the switchgear metal plate must be connected to earth (ground) for safety purposes.
2. All incoming AC power and other power sources are turned OFF before performing any work on the instrument. Failure to do so may result in serious or even fatal injury and/or equipment damage.
3. Before connecting the instrument to the power source, check the labels at the front of the instrument to ensure that your instrument is equipped with the appropriate rating input voltages and currents.
4. Under no circumstances should the instrument be connected to a power source if it is damaged.
5. To prevent potential fire or shock hazard, do not expose the instrument to rain or moisture.
6. While wiring the instrument CT primary or HACS to the secondary of an external third party current transformer, the external current transformer secondary output must never be allowed to be open circuit when the primary is energized. An open circuit can cause high voltages, possibly resulting in equipment damage, fire and even serious or fatal injury. Ensure that the current transformer wiring is secured using an external strain relief to reduce mechanical strain on the screw terminals, if necessary.
7. Only qualified personnel familiar with the instrument and its associated electrical equipment must perform setup procedures.
8. It is required to use a 2A Low-Voltage Circuit Breaker before connecting to Mains (voltage inputs)
9. It is recommended to use non-insulated ferrules as wire terminal, such as: P/N: F77-8-M – Manufacturer: PANDUIT
10. There shall be reliable segregation or separation by barriers between the following different circuits:
 - a) Class 1 field and factory installed wiring (such as CT output leads, voltage measurement leads, mains input power), terminals, and uninsulated live parts; and
 - b) Class 2 and Class 3 field installed and factory wiring, terminals, and uninsulated live parts.

Typical Installation

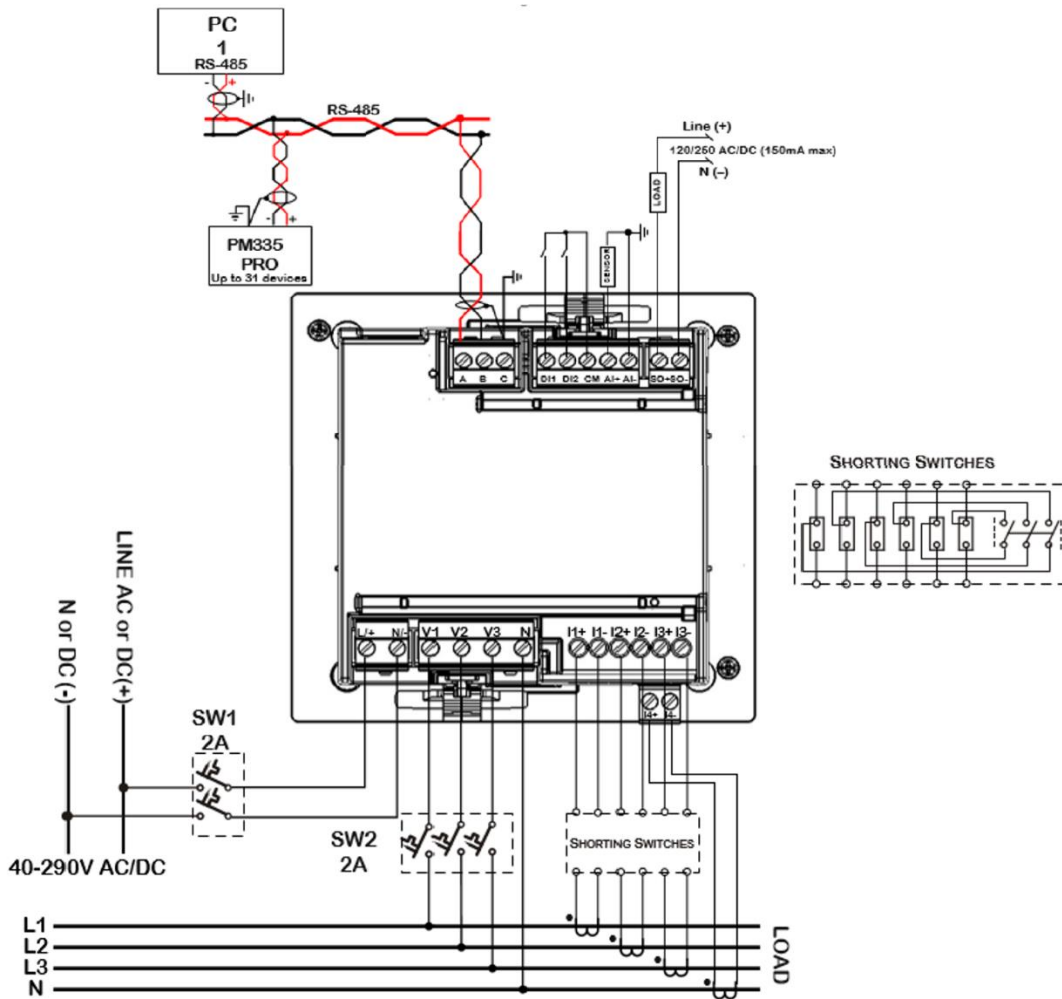

Figure 2-8a PM335 Typical Installation Diagram

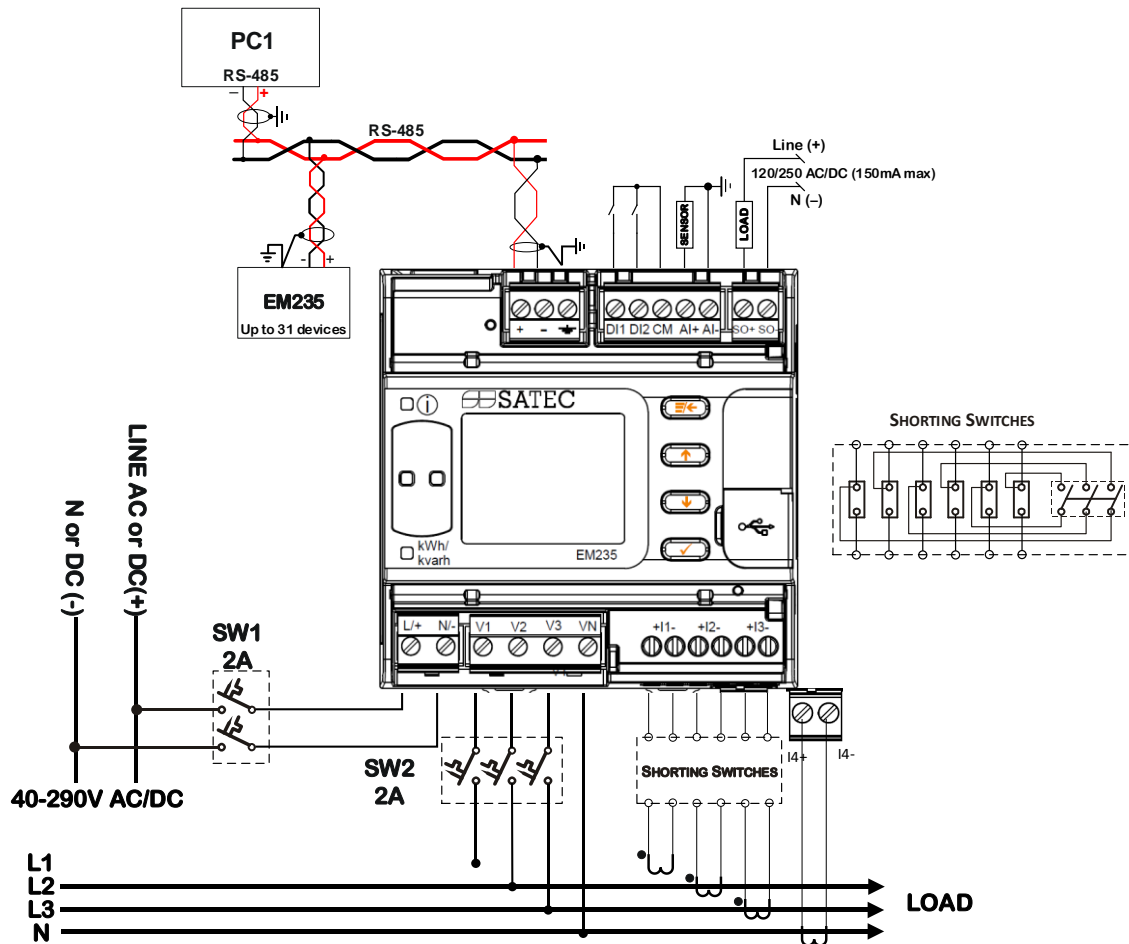

Figure 2-9b EM235 Typical Installation Diagram

Connecting the wires

All conductors must be stranded copper. All conductors and insulation systems and crimped devices must be appropriate for the application. SATEC recommends using crimped ferrules on stranded wire.

Table 3 below summarizes the different conductors' sizes to be used in the EM235/PM335 PRO SERIES external connections.

Table 3: Wiring Characteristics

Terminals	Conductor size			Torque [Nm]	Notes
	PRO model	Minimum AWG (mm ²)	Maximum AWG (mm ²)		
Aux. Power Supply Inputs L/+, N/-	ALL	22 (0.5)	12 (2.5)	0.5-0.7	Use 600V insulated conductors Required crimped ferrule: Panduit (22AWG) F75-10-M Panduit (12AWG) F81-10-M
Voltages Inputs V1, V2, V3, Vn	ALL	22 (0.5)	12 (2.5)	0.5-0.6	Use 600V insulated conductors Required crimped ferrule: Panduit (22AWG) F75-8-M Panduit (12AWG) F81-10-M
Current Inputs I1, I2, I3, I4	ALL	14 (1.5)	12 (4)	0.35-0.4	Use 600V insulated conductors Required crimped ferrule: Panduit (26AWG) F75-8-M Panduit (12AWG) F81-10-M
COM1, I/O connections		26 (0.5)	12 (2.5)	0.5-0.6	Use 600V insulated conductors Required crimped ferrule: Panduit (22AWG) F75-8-M Panduit (12AWG) F81-10-M

The wires temperature rating should withstand the "Limited Operating temperature range".

Terminals

All used terminals consist of detachable terminal, except for the current measurement inputs terminals.

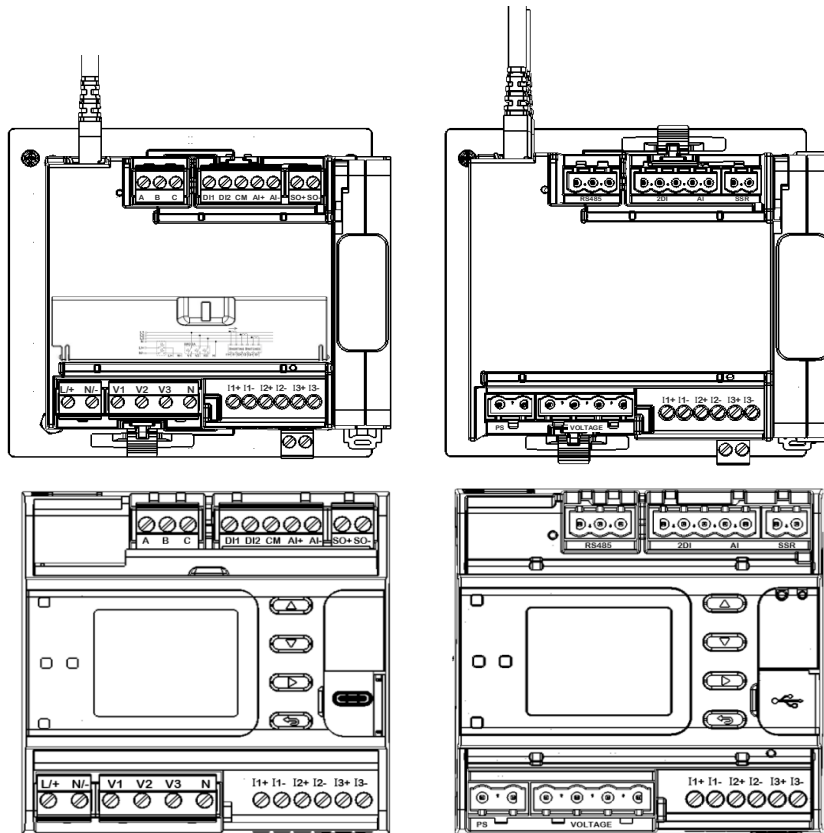

Figure 2-10 EM235/PM335 PRO Terminals View

Power Source Connection

The equipment installation shall conform to the following instructions:

- a) a switch or circuit-breaker shall be included in the building installation;
- b) It shall be in close proximity to the equipment and within easy reach of the OPERATOR;
- c) It shall be marked as the disconnecting device for the equipment.



Before installing, ensure that all incoming power sources are shut OFF. Failure to observe this practice can result in serious or even fatal injury and damage to equipment.

The power source can be a dedicated fuse, or a monitored voltage if it is within the instrument power supply range.

To connect an AC power supply:

1. Connect the Line wire to terminal L/+.
2. Connect the Neutral wire to terminal N/-.

To connect to a DC power supply:

1. Connect the positive wire to terminal L/+
2. Connect the negative wire to terminal N/-.

Voltage Input connection



- The equipment installation shall conform to the following instructions:
- a switch or circuit-breaker shall be included in the building installation;
 - It shall be in close proximity to the equipment and within easy reach of the OPERATOR;
 - It shall be marked as the disconnecting device for the equipment.

Before installing, ensure that all incoming power sources are shut OFF. Failure to observe this practice can result in serious or even fatal injury and damage to equipment.

690V Inputs

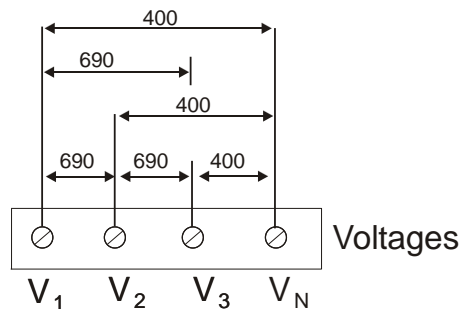

690V inputs are usually used with direct connection. Use any of the seven wiring configurations shown in Figures 2-8 through 2-15.

120V Inputs

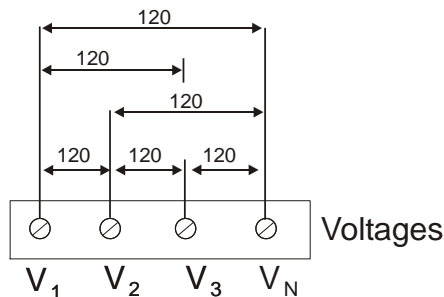

120V inputs usually imply use of a potential transformer (PT). The PT requires use of any of the four wiring configurations shown in Figures 2-7 through 2-10.

Current Input Connection

The EM235/PM335 PRO series provide two different CT connections:

- Using internal CT, connect the primary winding at the current terminals following the current flow polarity
- Using external CT (HACS – High Accuracy SATEC Current Sensor), connect the HACS secondary winding at the current terminals following the current flow polarity.

-
-
-
-

Wiring Diagrams

For AC input ratings, see [Technical Specifications](#) in Chapter 14 for more details.

Table 4 presents the available wiring configurations in the meter. For more details, see [Basic Meter Setup](#) in Chapter 5.

Table 4: Wiring Configurations

Wiring Configuration	Setup Code	Figure
3-wire 2-element Delta direct connection using 2 CTs	3dir2	2-11
4-wire 3-element Wye direct connection using 3 CTs	4LN3	2-12
4-wire 3-element Wye connection using 3 PTs, 3 CTs	4Ln3 or 4LL3	2-13
3-wire 2-element Open Delta connection using 2 PTs, 2 CTs	3OP2	2-14
4-wire 2½-element Wye connection using 2 PTs, 3 CTs	3Ln3 or 3LL3	2-15
3-wire 2½-element Open Delta connection using 2 PTs, 3 CTs	3OP3	2-16
4-wire 3-element Delta direct connection using 3 CTs	4LL3	2-17
3-wire 2½-element Broken Delta connection using 2 PTs, 3 CTs	3bLn3 or 3bLL3	2-18

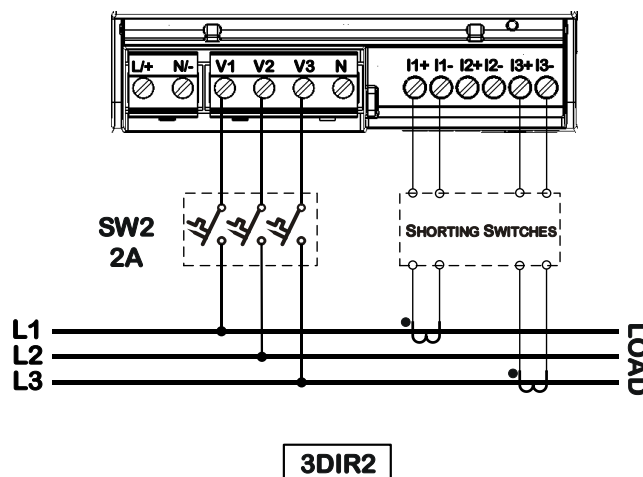

Figure 2-11 3-Wire 2-Element Delta Direct Connection Using 2 CTs (Wiring Mode = 3DIR2)

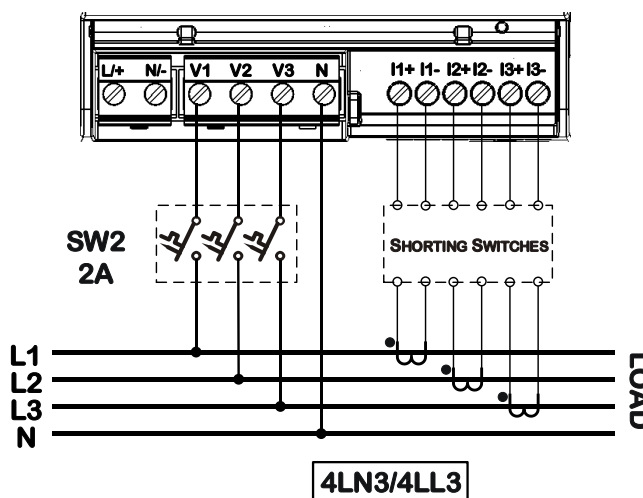

Figure 2-12 4-Wire Wye 3-Element Direct Connection Using 3 CTs (Wiring Mode = 4LN3)

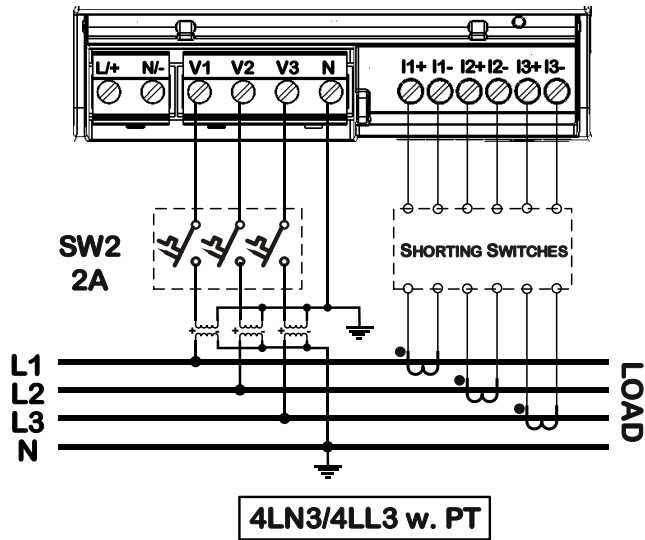

Figure 2-13 4-Wire Wye 3-Element Connection Using 3 PTs, 3 CTs (Wiring Mode = 4LL3 or 4LN3)

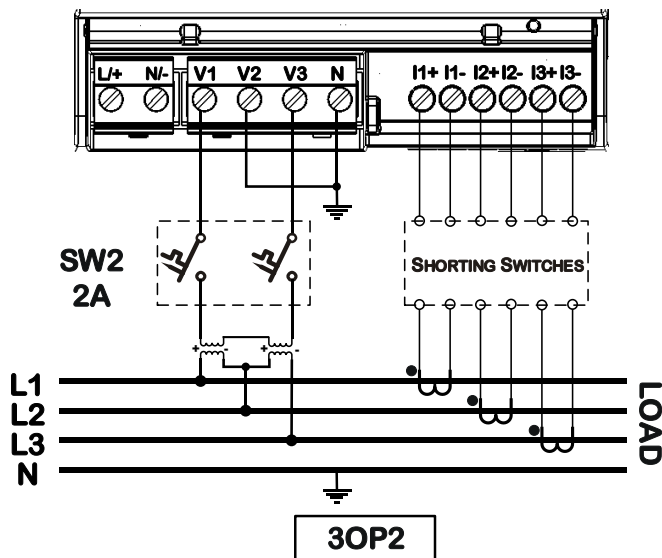
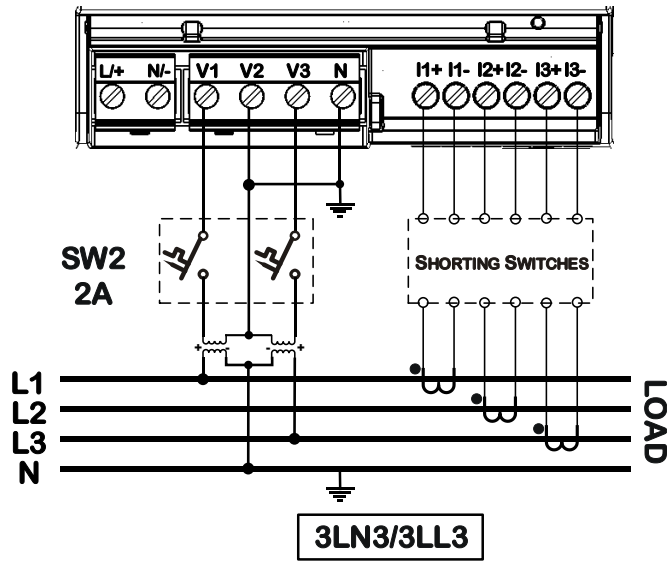

Figure 2-14 3-Wire 2-Element Open Delta Connection Using 2 PTs, 2 CTs (Wiring Mode = 3OP2)



This configuration provides accurate power measurements only if the voltages are balanced.

Figure 2-15 4-Wire Wye 2½-Element Connection Using 2 PTs, 3 CTs (Wiring Mode = 3LL3 or 3Ln3)

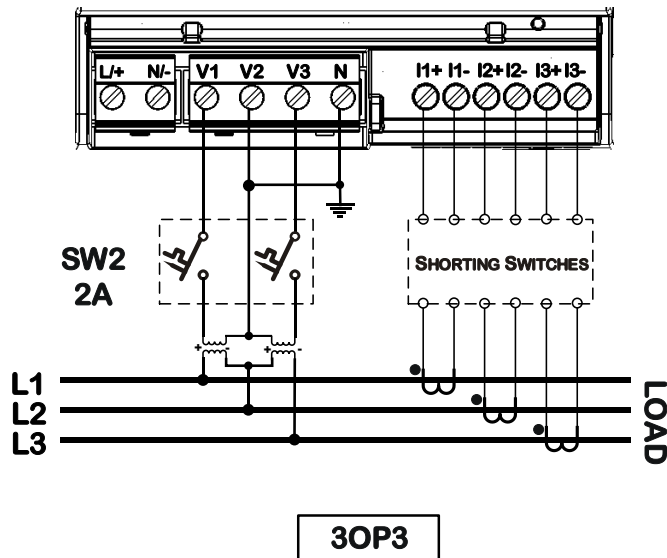

Figure 2-16 3-Wire 2½-Element Open Delta Connection Using 2 PTs, 3 CTs (Wiring Mode = 3OP3)

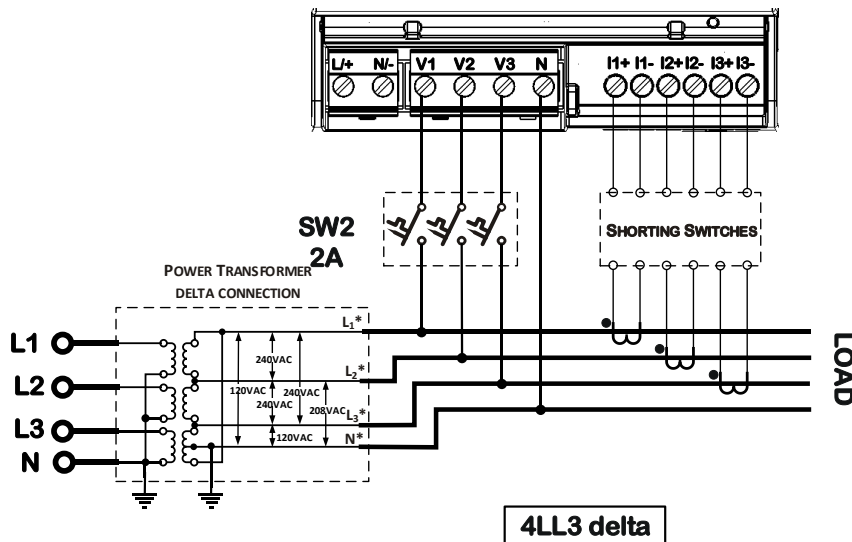

Figure 2-17 4-Wire 3-Element Delta Direct Connection Using 3 CTs (Wiring Mode = 4LL3 or 4Ln3)

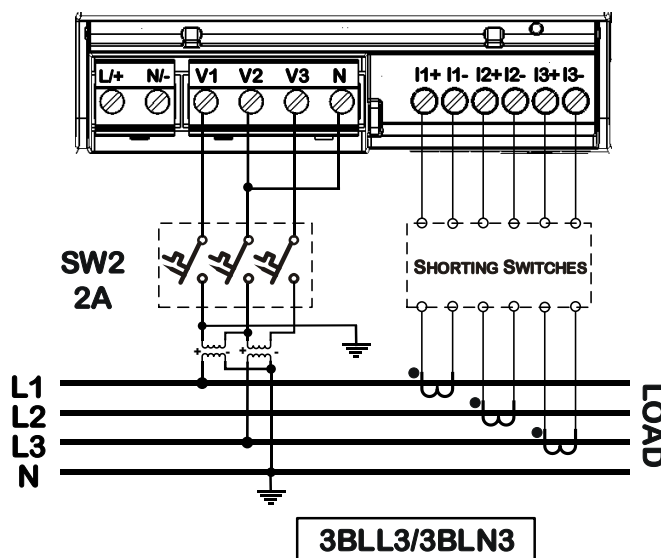

Figure 2-18 3-Wire 2½-Element Broken Delta Connection Using 2 PTs, 3 CTs (Wiring Mode = 3bLn3 or 3bLL3)

DC voltage measurement

EM235/PM335 PRO enables measuring 1-4 independent DC sources via 3 independent DC voltage Inputs.

When the Pro device is used as a single DC meter V1 and I1 shall be used. V2 and V3 must be connected to GND.

When the Pro device is used as a multichannel DC meter. V1/I1, V2/I2, V3/I3 and V3/I4 serve as independent channels/meters.

EM235/PM335 PRO Measures up to 800V DC via direct connection to the Pro meter:

Measuring 1500V DC and 2500V DC systems is possible via the SATEC Voltage Ratio Module (VRM).

When using the VRM, it is recommended that the distance between the SATEC VRM and SATEC meter should not exceed 2 meters, using cabling featuring minimum 600V insulation.

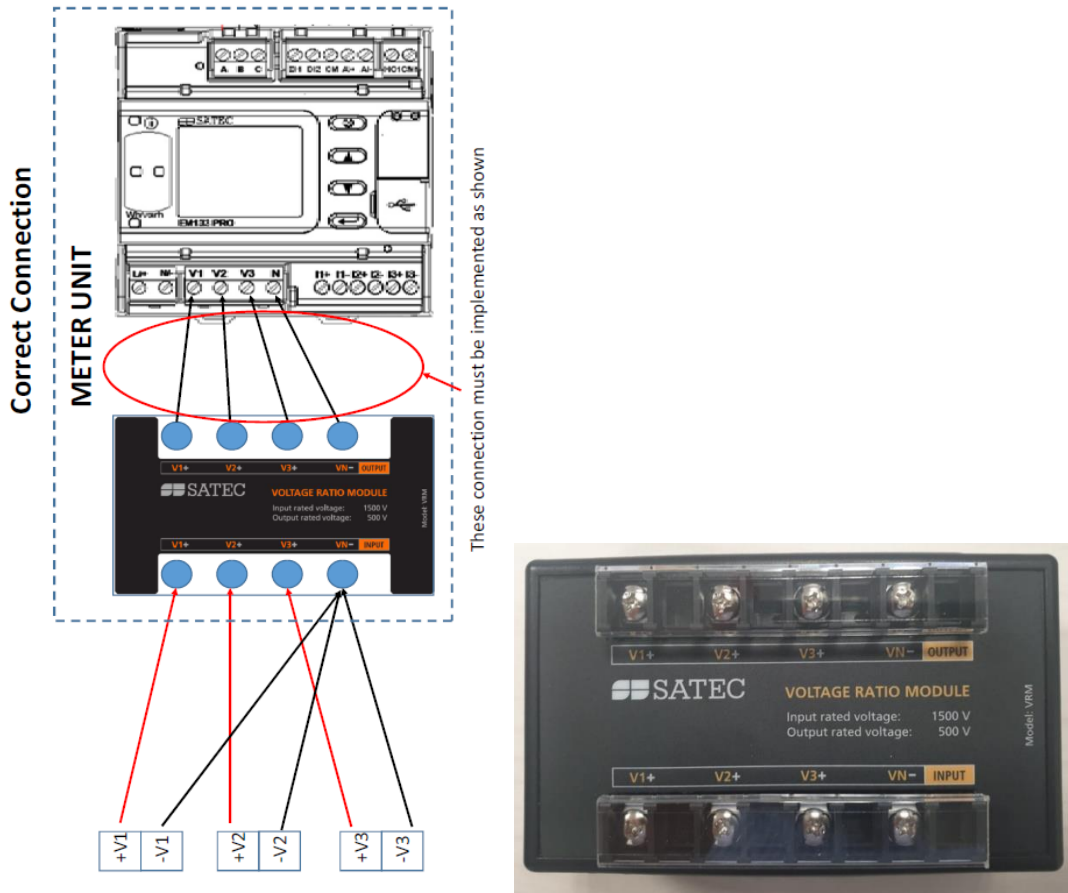

Voltage Ratio Module Characteristics:

- Accuracy = 0.1%
- 3 Independent voltage inputs
- DIN-rail installation

When using the SATEC VRM, the correct ratio coefficient must be set with PAS software (“basic configuration” tab): “PT ratio” = 3.5

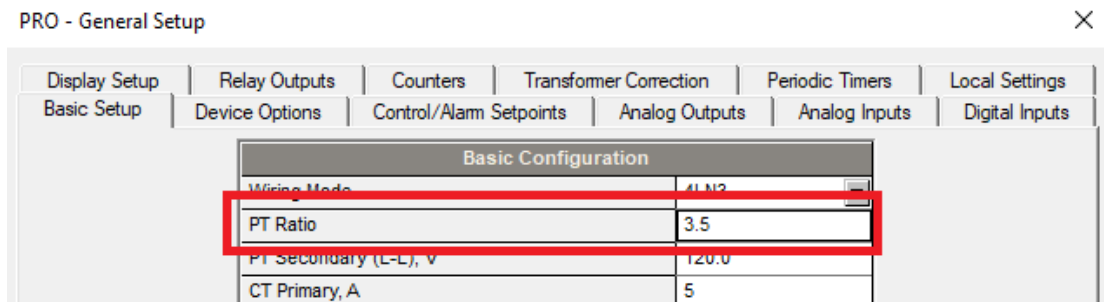

DC current measurement (hall effect sensors)

EM235/PM335 has 4 independent current inputs rated at 20mA nominal current, to which the user may connect standard hall effect sensors featuring 0-20mA/+20mA outputs.

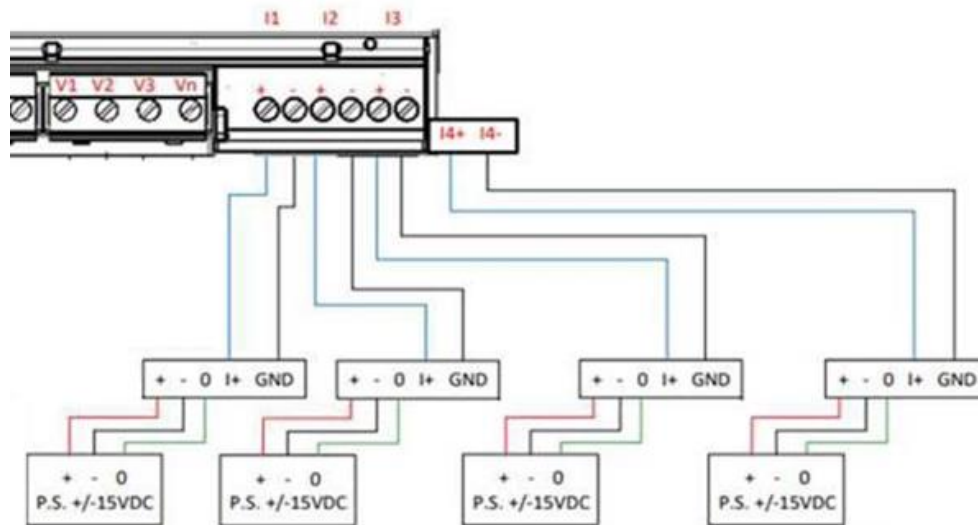

Notes:

- It is mandatory to use cabling featuring double insulation (600V) when connecting HE sensors to PRO Series meters.
- It is mandatory to use a separate power supply for each sensor.

Requirements for power supply for Hall Effect Sensors:

- Double insulation
- No Ground connection permitted
- Overvoltage withstand of 3kV or more
- Satec HEPS (Hall effect sensor power supply) or: 15V DC or +/- 15VDC (or 12VDC) power supply, depending on HSE type
- UL Listed

DC power is calculated with indication for power flow direction.

Energy is calculated for each channel separately (except for I4).

Typical Current measurement accuracy: better than 0.5% (depending on HES type)

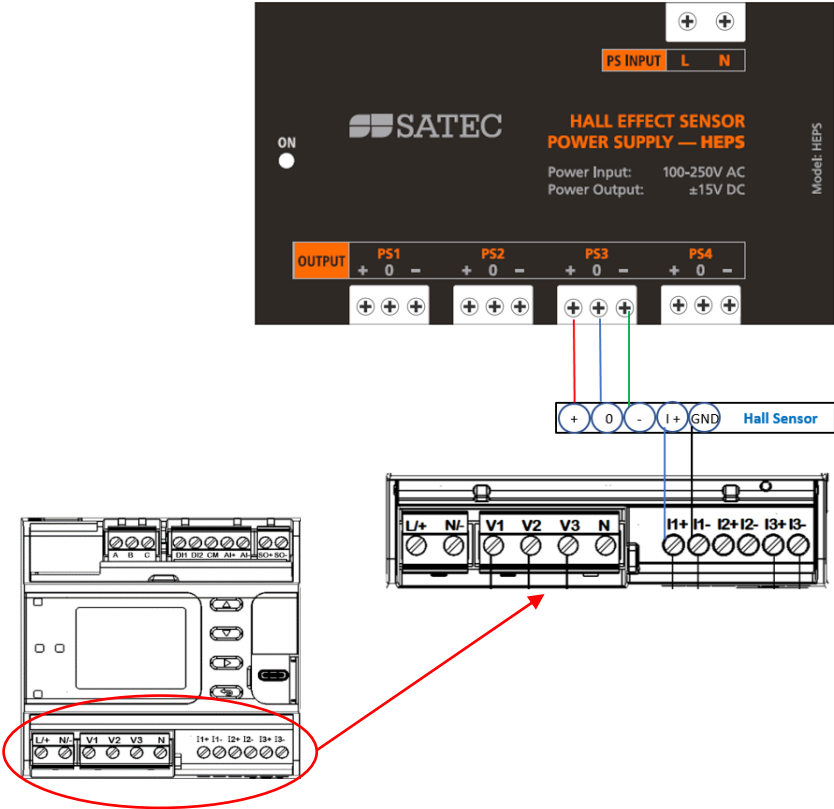

DC setup

DC setup is defined through PAS or through the meter basic setup menu

Setup menu

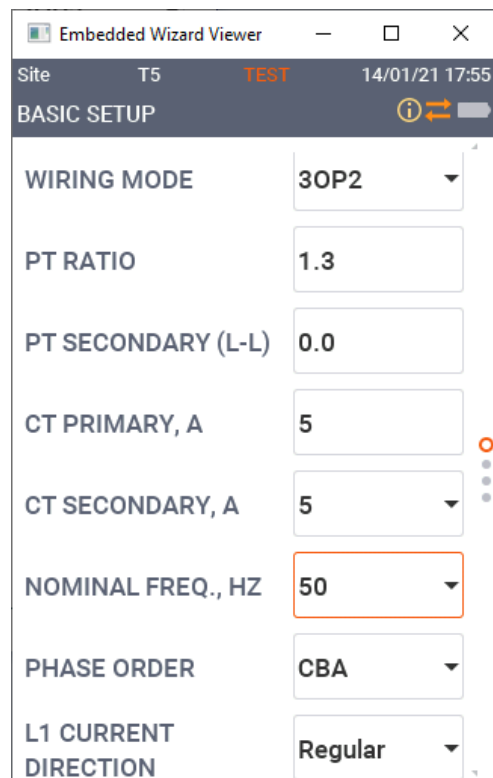

Embedded Wizard Viewer

Site T5 TEST 14/01/21 17:55

BASIC SETUP

WIRING MODE	3OP2
PT RATIO	1.3
PT SECONDARY (L-L)	0.0
CT PRIMARY, A	5
CT SECONDARY, A	5
NOMINAL FREQ., HZ	50
PHASE ORDER	CBA
L1 CURRENT DIRECTION	Regular

Nominal freq section in the basic setup enables choosing DC.

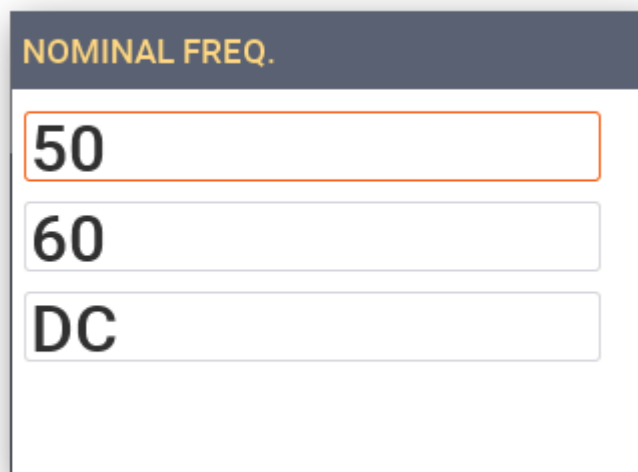

NOMINAL FREQ.

50

60

DC

Note: DC option will appear in the menu **for HACS input meters only**

PAS menu

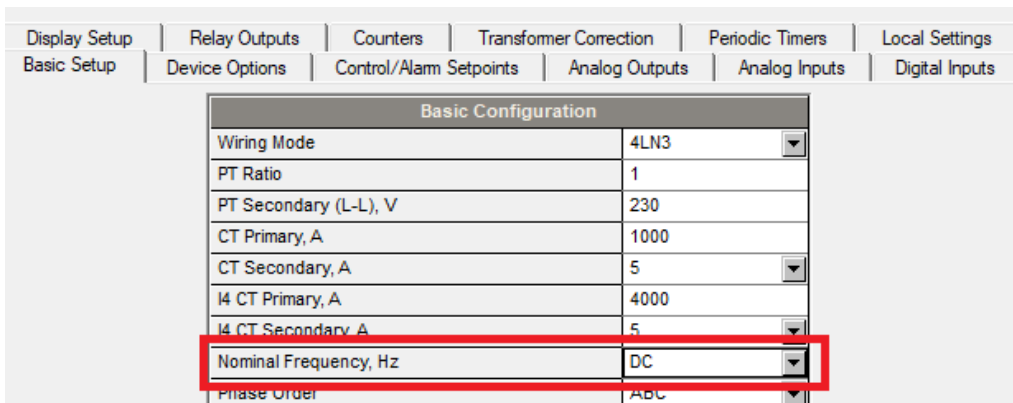

Note: DC option will appear in the menu for HACS input meters only

I/O Connections

Built-in I/O connections

The EM235/PM335 PRO are equipped with 2 built-in optional digital inputs, 1 relay output and 1 analog input, for I/O ratings see [Technical Specifications](#) in Chapter 14.

- Two optically isolated status inputs are provided for status monitoring, pulse counting, external power demand period, and time synchronization at 1ms sampling rate
- One Solid State relay output provided for energy pulsing, alarms, or remote control
- One optically isolated analog input with an internal power supply and current input sensing of -1mA to 20 mA

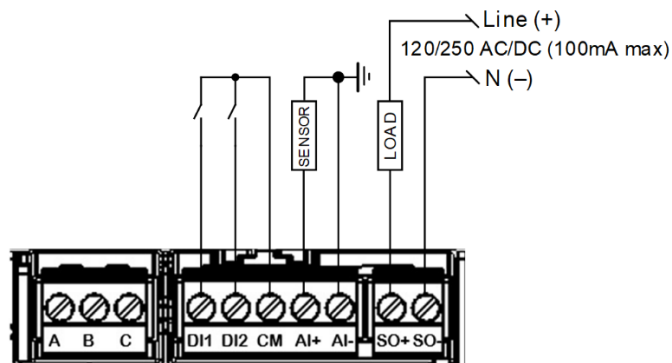



Figure 2-19 EM235/PM335 PRO built-in I/O wiring connections

Warning: Restriction of the built-in relay output to use mains circuits switching

I/O module installation and connection

 Before I/O Module installation ensure that all incoming power sources are shut OFF. Failure to observe this practice can result in serious or even fatal injury and damage to equipment.

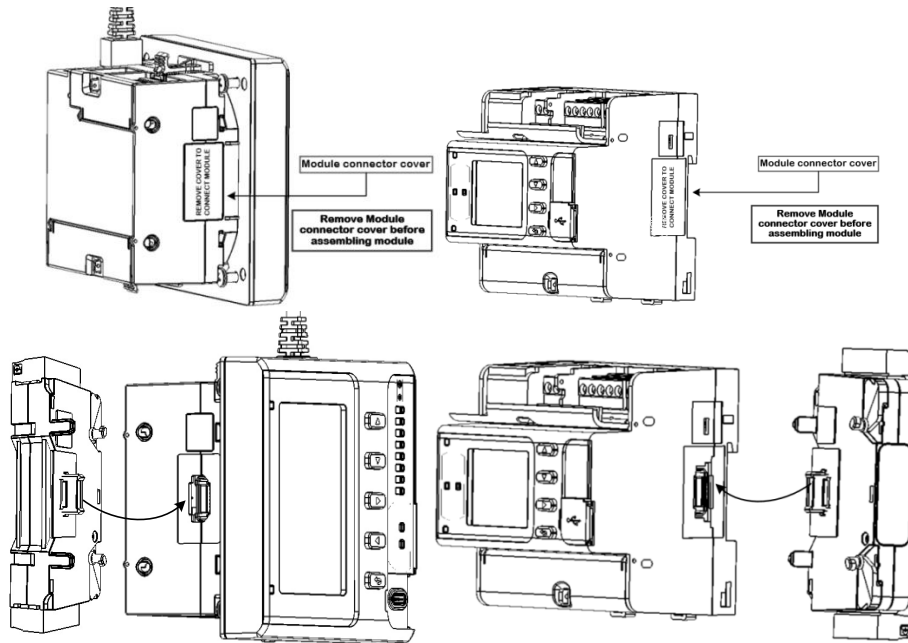

Figure 2-20 Module Connector Cover - Before Module Assembly

For I/O ratings, see [Technical Specifications](#) in Chapter 14.

External Modules connection to Pro

EM235/PM335 might be connected to up to 3 external modules from different kinds according to the needed application. The external modules includes digital input and outputs from various types.

Basically, Connecting 1 module doesn't require external aux power supply.

When connecting more than 1 external module external aux power supply is needed.

Note: The external aux power supply is connected as an add on external module to the 3 externally connected modules.

There are certain configurations and connections depending on the modules connected externally that enables connecting more than 1 module with no need for external aux power supply. The below table defines the approved configurations and the temperature limits while using this special configurations.

Module oper Temperature__	8DI-DRY	8DI-WET	4DO	CELL	AUX PS
-40...50°C	2	NO	NO	NO	NO
-40...50°C	NO	3	NO	NO	NO
-40...50°C	NO	NO	2	NO	NO
-40...50°C	1	NO	1	NO	NO
-40...50°C	NO	1	1	NO	NO

-40...50°C	NO	NO	NO	1	NO
-40...70°C	1	NO	NO	NO	NO
-40...70°C	NO	1	NO	NO	NO
-40...70°C	NO	NO	1	NO	NO
-40...70°C	NO	NO	NO	1	NO
-40...70°C	3	NO	NO	NO	YES
-40...70°C	NO	3	NO	NO	YES
-40...70°C	NO	NO	3	NO	YES
-40...70°C	2	NO	1	NO	YES
-40...70°C	1	NO	2	NO	YES
-40...70°C	NO	2	1	NO	YES
-40...70°C	NO	1	2	NO	YES
-40...70°C	1		1	1	YES
-40...70°C	NO	1	1	1	YES
-40...70°C	2	NO	NO	1	YES
-40...70°C	NO	2	NO	1	YES
-40...70°C	NO	NO	2	1	YES

8 DI Module

Eight optically isolated status inputs are provided for status monitoring, pulse counting, external power demand period, and time synchronization.

The EM235/PM335 PRO series can be equipped with up to 3 x 8DI modules



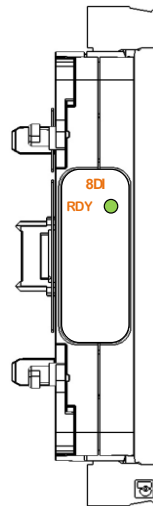

Figure 2-21 8 DI - Front view & Digital Input Connection - Dry contact model

In case of Dry contact module the internal 24VDC power supply is operated.



Figure 2-22 8 DI - Digital Input Connection – Wet contact model

In case of Wet contact module the external power supply is operated: 24V, 48V, 125V, 250V.

The wet contact source may have any polarity (or AC: 50/60Hz).

The Voltage Inputs must have the one common wire.

4RO Module

The 4RO module has four electro-mechanic relays (EMR) or solid state relays (SSR) outputs provided for energy pulsing, alarms, or remote control. Up to 3 modules can be installed

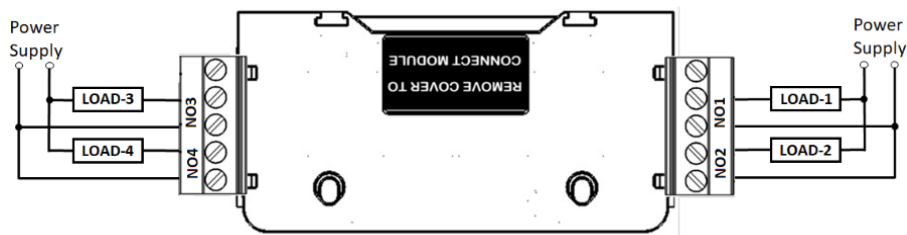

Figure 2-23: 4RO Module Connection

AUX_PS Module

The AUX_PS module designed to increase the power ability of the meter. In case of three optional modules connected to meter use Auxiliary Power Supply as a fourth module. Voltage range of AUX PS: 88-264AC, 125-300 VDC.



Figure 2-24: AUX_PS Module Connection

Communications Connections



Before installing any Communication Module, ensure that all incoming power sources are shut OFF. Failure to observe this practice can result in serious or even fatal injury and damage to equipment.

Several communication module options are available for the EM235/PM335 PRO:

- Built-in serial Communication COM1: RS-485
- Built-in Infra-Red serial Communication COM4: IR
- Built-in USB Device Communication: USB-C connector
- Built-in 2 x 10/100Base T ETHERNET Communication – Daisy Chain or double independent Ethernet ports: RJ-45 connector
- 3 x 5mm pitch detachable terminal block for COM2 RS485 connection

A full description of the communication protocols is found in the EM235/PM335 PRO protocol guides that come with your meter.

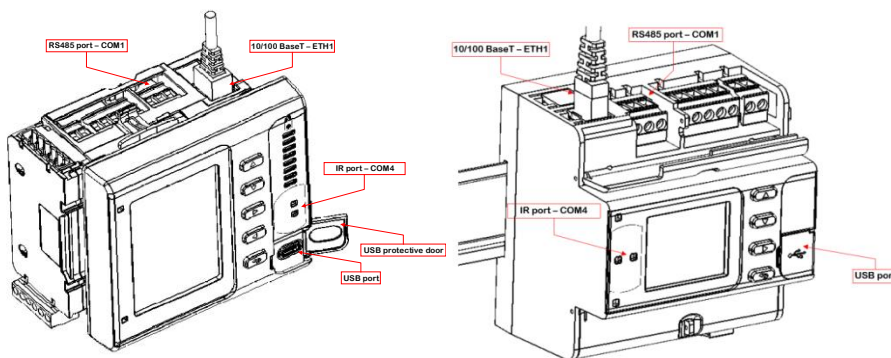

Figure 2-25: Communication ports location

COM1 RS-485 Connection

Built-in communication port COM1

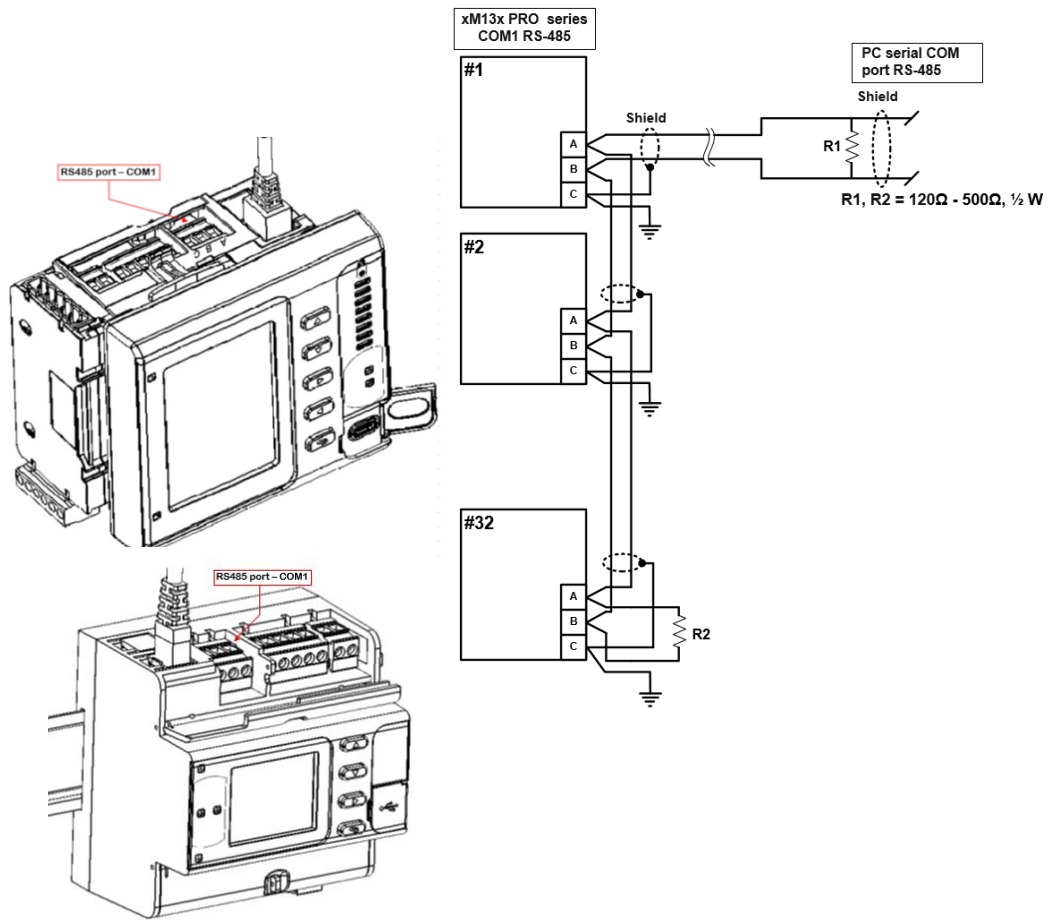

Figure 2-26: COM1 RS-485 2-Wire Connection

The connector is removable with three captured-wire terminals.

Ethernet Connection

The external equipment TERMINAL connection type is RJ-45

The type of equipment that might be connected to the TERMINAL is:

Personal Computer –

- PC or LAPTOP 10/100Base-T
- LAN HUB and/or Switch

The RATING of the insulation of the external equipment for use with the ETH port, shall comply according to Installation Category III for insulation to be suitable for SINGLE FAULT CONDITION

ETHERNET 1 connection

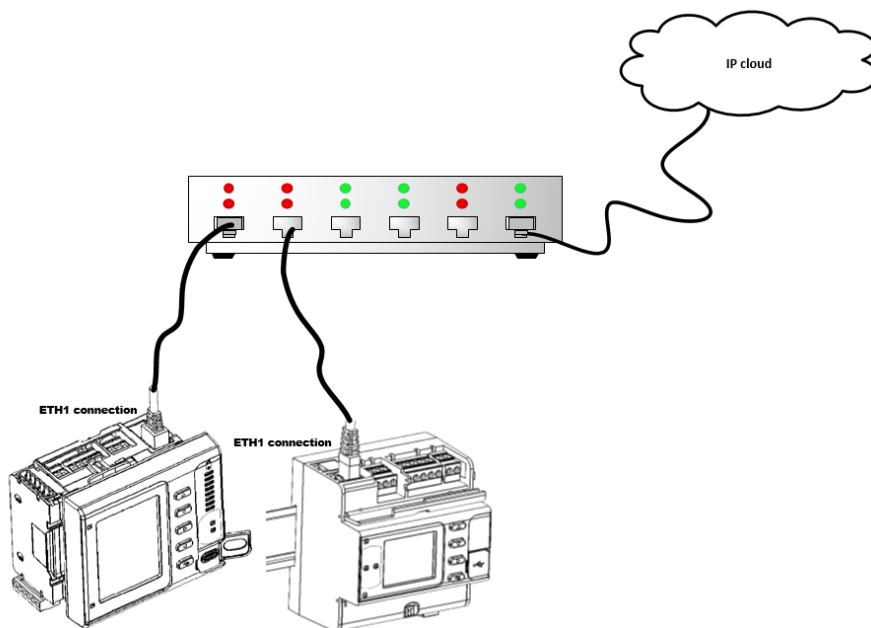

Figure 2-27: Ethernet 1 Connection - RJ45 connection

ETHERNET Daisy Chain connection

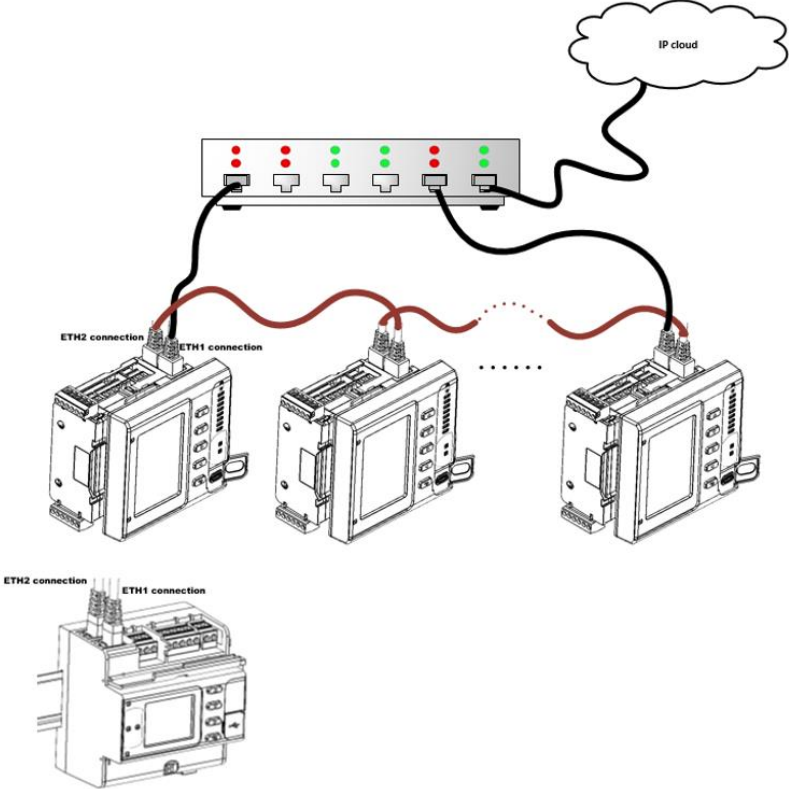

Figure 2-28: Ethernet Daisy Chain Connection with fall back (RSTP support)

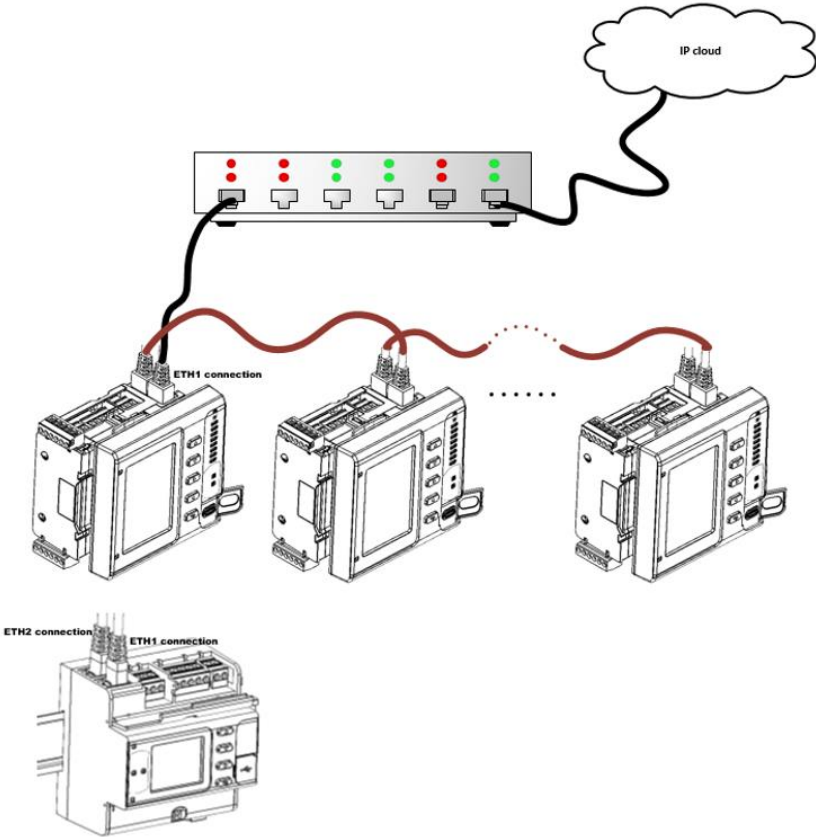

Figure 2-29: Ethernet Daisy Chain Connection with fall back (RSTP support)

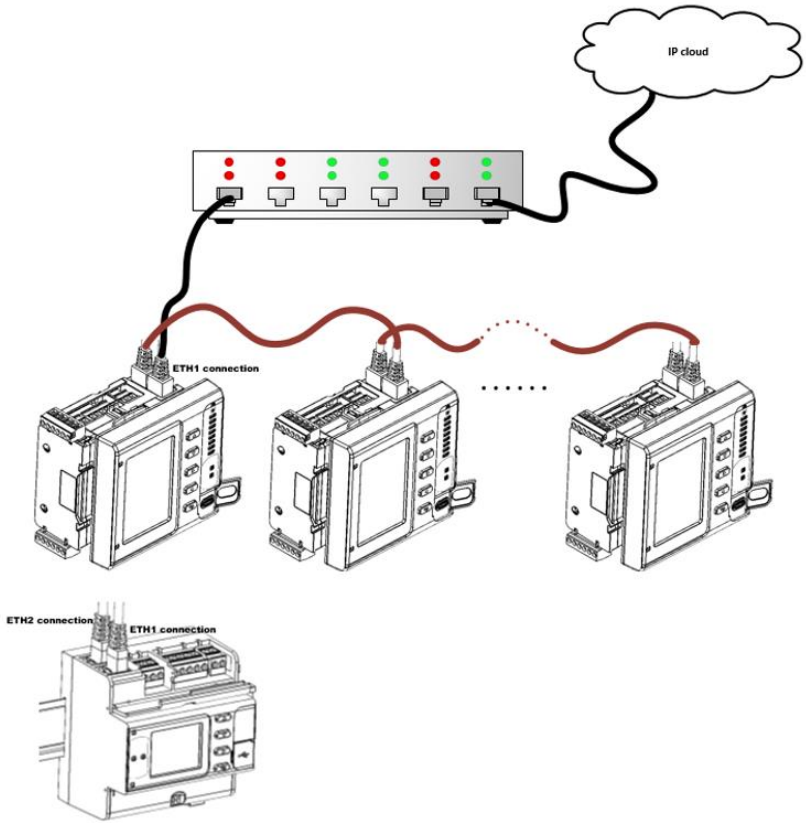

Figure 2-30: Ethernet Daisy Chain Connection without fall back

Double ETHERNET connection

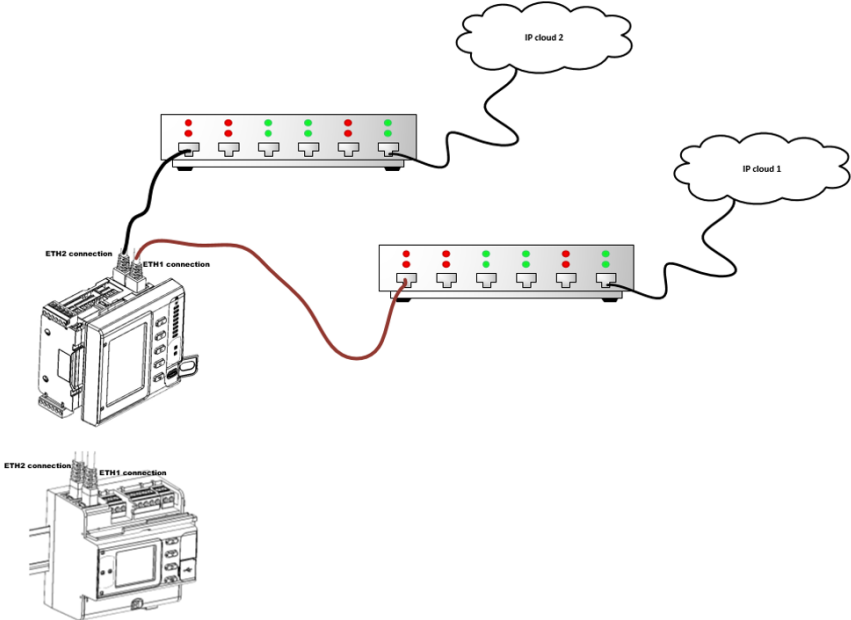

Figure 2-31: Double Ethernet Connection

USB connection



To prevent potential differences between the Personal Computer (PC) USB port and the EM235/PM335 PRO USB device port, it is recommended to use a galvanic isolated USB adaptor before connecting the EM235/PM335 PRO USB port to a Personal Computer (PC), or to use battery powered PC.

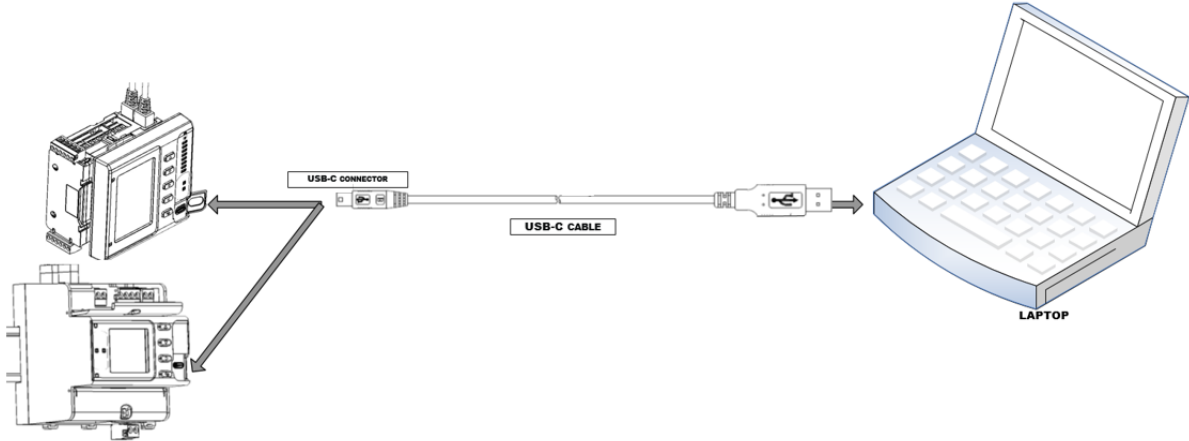

Figure 2-32: USB connection – USB-C connection

Chapter 3 Operating the EM235/PM335 PRO

Control and Indicators

Device Controls

The EM235/PM335 PRO is entirely controlled either from the display unit, or by using the supplemental PAS power analysis software package.

Indicator LEDs

The EM235/PM335 PRO has three status indicator LEDs that show present device operation status and give diagnostics indication; one energy pulsing LED that output kWh/kvarh pulses, located on the attached Display; and Load bar.

LED Name	Color	Status	Description
CPU	Green	Flashing 1 sec On, 1 sec Off	Device operational and is functioning normally.
		Flashing 2 flashes, 1 sec Off	Device is in the Service Mode and is not operational.
		Flashing 3 flashes, 1 sec Off	A critical error has occurred - the device is not operational. Device servicing is required. For more information, see Diagnostics Mode below.
MAIN POWER	Green	On	Voltage is supplied to the main power supply unit.
BACKUP POWER	Green	On	Voltage is delivered to the backup power supply unit.
kWh/kvarh	Red	Flash at user-programmed rate	The device measures imported (consumed) active and reactive energy. For information on defining the LED pulse rate, see Advanced Device Setup in Chapter 6.

Modes of Operation

The EM235/PM335 PRO can run in the following modes:

Operational Mode

Operational Mode is the common operation mode. All device features are available.

When the device is in Operational Mode the CPU LED flashes for 1 second with a 1-second pause.

Energy Test Mode

Energy Test Mode tests the device energy measurement accuracy. All basic measurements are available; energy accumulators are not affected; setpoints operation, fault and power quality recorders are stopped. To put the device into the Energy Test Mode, see [Device Options Menu](#) in Chapter 3, or [Device Mode Control](#) in Chapter 10.

Service Mode

Service Mode is used for local upgrading of EM235/PM335 PRO firmware. When the device enters Service Mode, the CPU LED briefly flashes 2 times with a 1-second pause.

In Service Mode, all device operations are stopped.

Diagnostics Mode

The device enters Diagnostics Mode when the internal diagnostics detects a critical error that affects the normal device operation. All device operations are stopped until the critical error is cleared. All communications ports are still available. See [Device Diagnostic Codes](#) in Chapter 20 for the list of diagnostic events that cause a critical error. See [Device Diagnostics](#) for more information on the EM235/PM335 PRO built-in diagnostics.

When the device is in Diagnostics Mode, the CPU LED briefly flashes 3 times with a 1-second pause, and the display unit shows a diagnostic message.

For more information on indication and clearing the device diagnostics, see [Status Information Display](#) in Chapter 3, [Viewing and Clearing Device Diagnostics](#) in Chapter 3, and [Viewing and Clearing Device Diagnostics](#) in Chapter 10.

Communicating with the EM235/PM335 PRO

Communication with the EM235/PM335 PRO can be established independently and simultaneously through any communications port using the support PAS program supplied with the device or user application software. All communication ports are slave ports and have factory-preset parameters, such as baud rate, data format, and communications protocol that can be easily changed whenever desired.

COM1-COM4 Serial Communications (standard)

The EM235/PM335 PRO has three standard serial communication ports COM1 through COM4 for communicating with the master workstations, RTUs, PLCs or PAS™@ PCs, and with an optional remote display. All serial ports can operate in the RS-485 two-wire mode. The COM1 is an RS-485 port. The COM2 ports can also be used for RS-485 two-wire communication (on add-on module). Local programming and upgrading the device firmware can be established by any communication port.

All ports are optically isolated and can operate at baud rates up to 115200 bps. Each port can be set up for any communication protocol supported by the EM235/PM335 PRO independently from other ports. All ports are factory preset to 19200 bps, 8-bits/No-parity data format, and programmed for the Modbus RTU protocol.

The COM3 port has different connection terminals and is intended for communication with the LED display unit (RDM – future release)

The IR port is identified in the EM235/PM335 PRO as the COM4 port. It is factory preset to 19200 bps, 8-bits/No-parity data format, and programmed for the MODBUS RTU protocol. The IR port can be equipped with an IEC- or ANSI-compatible optical head.

See [Configuring Serial Ports](#) in Chapter 5, for information on how to set up serial ports in your device. For wiring diagrams, refer to [Communication Connections](#).

USB Port (standard)

A USB node port is intended for local communications with the support PAS software. It is directly connected to your PC's USB port using the supplied USB cable. The USB communications does not require any settings. Just connect your PC to the EM235/PM335 PRO USB port and install the supplied USB driver (see [Installing the USB Driver](#) in Chapter 6). The USB communications is ten times faster than the serial communications can provide at a maximum baud rate.

Ethernet Port

One or two 10/100Base-T Ethernet ports provide a direct connection of the EM235/PM335 PRO to a local area network through the TCP/IP protocols. The device has three onboard TCP servers configured for the Modbus/TCP (at TCP port 502), DNP3.0/TCP (at TCP port 20000) and IEC 60870-5-104 (at TCP port 2404) communications. The TCP servers can support up to 10 simultaneous connections with MODBUS/TCP, DNP3.0/TCP and IEC 60870-5-104 client applications.

Connection through the Ethernet port does not require device identification. The EM235/PM335 PRO responds to any device address and returns the received address in the response message. The two Ethernet ports can either be configured for separate and independent ethernet port or used for daisy chain configuration

Note

To provide simultaneous file services for all ports, the EM235/PM335 PRO keeps independent file pointers for each communications port. For a TCP port, the EM235/PM335 PRO holds separate file pointers for each active TCP socket. The TCP server automatically closes a connection if a socket is idle for more than 5 minutes. There is no guarantee that a new connection is established at the same socket, so do not make any assumptions regarding the current file status when starting a new connection from your application. Always initialize a file pointer to a record from where you expect

to begin reading a file. For more information, see “File Transfer” in the EM235/PM335 PRO MODBUS Communications Guide.

Using PAS

PAS is the support software supplied with the EM235/PM335 PRO that gives the user basic tool for programming the device, performing remote control operations, monitoring real-time measurements, retrieving and analyzing historical data files, reviewing fault and power quality reports, and more.

PAS can communicate with the devices through any EM235/PM335 PRO port using the MODBUS RTU, MODBUS ASCII and DNP3.0 protocols. For information on installing and using PAS, see Chapter 5 [“Using PAS”](#).

Device Inputs

AC Inputs

The AC voltage and current input terminals are connected to the internal device circuits through high impedance input voltages and transformers input current that isolate the device from external wiring.

Voltage Inputs

The device has four high-impedance voltage inputs (direct 690V RMS phase-to-phase voltage, $\times 140\%$ overload). Voltage channels are designated as V1 through V3 and Vn.

The secondary voltage rating and primary to secondary voltage ratio (PT ratio) of the external potential transformers must be specified in your device to provide correct voltage measurements. For more information on specifying voltage input ratings in your device, see [Basic Device Setup](#) in Chapter 6.

The secondary rating of the voltage inputs is used as a reference for calculating thresholds for the power quality and fault triggers.

Current Inputs

The device is provided with current input transformers with either 5A or 1A rated current in the standard model.

For more information on specifying input ratings in your device, see [Basic Device Setup](#) in Chapter 6.

Sampling

7 AC channels (3 voltages and 4 currents) are continuously and simultaneously sampled at a rate of 256 samples per cycle (12.8 kHz at 50Hz or 15.36 kHz at 60Hz).

The sampling rate is precisely synchronized with the power frequency. The reference frequency signal is taken from one of the phase voltage inputs V1-V3, band-pass filtered, and then sampled at 12.5 MHz providing a 0.0004% cycle measurement error.

Waveform Tracing

The sampled waveforms are stored to the circular trace buffer whose depth is sufficient to provide up to 20 pre-fault cycles for the waveform recorder. The waveform recorder is synchronized with the sampling circuitry and can store unlimited number of post-event cycles. The length of the captured waveforms is only restricted by the size of the allocated logging memory.

Digital Inputs

The EM235/PM335 PRO can monitor 2 digital inputs in the device (optional) and up to 3 removable 8-channel digital input modules with a total of 26 inputs. The modules may be ordered with input options for dry contacts, or $\pm 24V$, $\pm 125V$ and $\pm 250V$ wet inputs.

All digital inputs are sampled at a rate of 16/20 (60/50 Hz) samples per cycle and synchronized to the AC sampling circuitry. This gives time stamping of the input transitions with a 1-ms resolution.

Digital inputs have a programmable debounce time from one to 100 milliseconds in groups of two inputs. Each input can be independently linked to any device counter, Energy/TOU system register, and setpoints.

Analog Inputs

The EM235/PM335 PRO monitors 1 on-device universal analog input (AI) and up to 2 removable 4-channels analog input modules, with a total of 9 AI, which may be used for measuring DC and low frequency currents and volts, temperature through temperature sensor.

The following AI modules may be ordered with the device:

- 4-channel optically isolated 4AI/AO modules with optional ranges of 0-1 mA, ± 1 mA, 0-20 mA, or 4-20 mA, 0-50 mA or ± 10 V. The 0-1 mA and ± 1 mA analog inputs can measure

200% overload currents up to 2 mA and ± 2 mA.

The EM235/PM335 PRO may be equipped with up to three 4AI/AO modules.

The scan time for regular analog inputs is 2 cycles (32 ms at @ 60Hz and 40 ms @ 50Hz). AI readings and triggers are updated each 1/2-cycle.

Each analog input can be independently scaled to provide true readings in the user-defined engineering units (see [Programming Analog Inputs](#) in Chapter 6).

NOTES:

1. If you use both 4AI/AO and 8AI modules in the same device, put the 4AI/AO module in slots with lower numbers, i.e., into the left side slots.
2. If you use regular 4AI/AO modules and fast 8AI modules, the regular inputs are scanned at a usual rate.

Device Outputs

Analog Inputs/Outputs (future release)

The EM235/PM335 PRO supports up to three removable 4AI/4AO modules with a total of 12 analog inputs/output versatile channels that can output DC currents proportional to the measured analog quantities. All outputs are optically isolated and have an internal power supply. The AI modules may be ordered with 0-1mA, ± 1 mA, 0-20mA, or 4-20mA output current. The 0-1mA and ± 1 mA analog outputs provide 200% overload currents up to 2 mA and ± 2 mA.

Update time for analog outputs is 2-cycles (32 ms at @ 60Hz and 40 ms @ 50Hz).

Each analog output can be independently scaled to provide the desired engineering scale and resolution (see [Programming Analog Outputs](#) in Chapter 6).

Relay Outputs

The EM235/PM335 PRO provides one on-device relay output (SSR) and up to 12 digital outputs through three plug-in 4-channel relay output modules. Each module has eight electro-mechanical relays 2-contact SPST Form A.

The following table shows timing characteristics of the relays and their expected lifetime.

Characteristic	Form A Relays
Operate time	10 ms
Release time	5 ms
Bounce time	1 ms
Mechanical endurance	10,000,000 operations
Electrical endurance (5A/250V)	50,000 operations

Each relay is independently programmable and operates in latched, unlatched, pulse or KYZ mode.

Relay operations can be inverted so that the relay is energized in its non-active state and de-energized when it is operated. This mode, known as “failsafe” mode, is used for signaling purposes to send alarms when the device is not operational either due to a fault or due to loss of power.

Latched and Unlatched Operation

Latched and unlatched mode of operation concerns local relay commands issued from the control setpoints.

In unlatched mode, a local setpoints command sent to the relay is automatically cleared; the relay is released when all setpoints linked to the relay return to non-operated state.

In latched mode, the operated relay is not released automatically when the conditions that caused the relay to operate are no longer present. To release a latched relay, an explicit release command must be sent either from a separate setpoint, or through communications. If the relay is locked in the operated state by a remote command, the local release command only clears the internal latch and the relay stays in operated state until the remote command is removed.

Pulse and KYZ Operation

Pulse mode causes a relay to produce a pulse with a predefined duration in response to a local or remote relay command. After a pulse is expired, the command is automatically cleared and the

relay is held up in released state for at least pulse width time before the next command is accepted.

The programmable pulse width is selected from 10 ms to 1 sec. The device scans all relays in 1/2-cycle time intervals. This means that the actual pulse width is a multiple of the 1/2-cycle time rounded to the nearest larger value. The programmable pulse width does not include the relay operate and release times.

In KYZ mode, every operate command changes the present state of a relay to the opposite state producing a transition pulse, and the relay is held up in this state for at least pulse width time before the next command is accepted. KYZ mode is commonly used with Form C relays to signal pulses by alternation of the two contact pairs.

Pulse and KYZ relays can be directly linked to the internal pulse sources to output energy or time interval pulses.

Remote Commands

A remote operate command forces a latched or unlatched relay to move to its active state. The relay is held in active state until the command is removed by a remote release command. The remote release command also removes the local commands that hold a latched relay in active state.

A remote operate command sent to a pulse or KYZ relay forces the relay to produce a pulse or changes its state. A remote release command sent to a pulse or KYZ relay has no effect since the operate command is cleared automatically for these relays.

Retentive Relays

Latched relays can be set to operate in retentive mode. Retentive mode affects the behavior of the relay after loss of power.

After restoring power, all non-retentive relays are in inactive state until local conditions are reevaluated. All active remote commands for non-retentive relays are cleared.

Retentive relays retain their status after restoring power, and all active remote commands that were issued before loss of power are still effective.

Critical Faults

When a critical error is detected by the device diagnostics, all relays are released regardless of their operation mode and all remote relay commands are removed.

Metering

RMS Measurements

All RMS quantities are based on 1/2-cycle true RMS measurements performed over 64 samples of the acquired waveforms. The 1/2-cycle quantities are values (normally, RMS volts, RMS currents and unbalances) measured over one cycle and updated each half cycle. This allows fast response to power quality and fault events.

RMS Trace

The EM235/PM335 PRO handles a circular RMS trace buffer that stores the last forty 1/2-cycle RMS, unbalance, zero-sequence and frequency readings. This allows the data recorder to provide 1/2-cycle trending of up to 20 pre-fault cycles when it is triggered from the Power Quality.

The following table lists parameters that are available for pre-fault tracing.

Parameter	Label
Phase-to-neutral volts	V1, V2, V3
Phase-to-phase volts	V12, V23, V31
Standard range currents	I1, I2, I3, I4
Standard range neutral current	In
Voltage zero sequence	V ZERO-SEQ
Standard range current zero sequence	I ZERO-SEQ
Extended range current zero sequence	Ix ZERO-SEQ
Voltage unbalance	V UNB%
Standard range current unbalance	I UNB%
Extended range current unbalance	Ix UNB%
Power frequency	Frequency

Data logs #13 (fault data trend) and Data logs #14 (PQ data trend) are internally linked to the RMS trace buffer. The number of pre-fault cycles for data trending is defined when configuring the Power Quality and Fault recorders. See [Configuring the Power Quality Recorder](#) and [Configuring the Fault Recorder](#) in Chapter 7.

Harmonic Measurements

The EM235/PM335 PRO provides harmonic measurements on three voltage channels V1-V3 and four standard range current channels I1-I4. To avoid erroneous harmonic readings when the high fault currents saturate current channels, the harmonics registers are not updated at the time of the fault.

The FFT analysis is performed over a 10-cycle waveform for 50Hz and 12-cycle waveform for 60Hz system, sampled at a rate of 256 samples per cycle. This gives spectrum components up to the 63rd harmonic.

The following table lists harmonic quantities provided by the device.

Parameter	Label
Total Harmonics	
Voltage THD	V1 THD – V3 THD
Current THD	I1 THD - I4 THD
Current TDD	I1 TDD - I4 TDD
Current K-factor	I1 KF - I4 KF
Voltage Crest-factor	V1 CF – V3 CF
Current Crest-factor	I1 CF - I4 CF
Total Interharmonics	
Voltage THD	V1 THD/I – V3 THD/I
Current THD	I1 THD/I - I4 THD/I
Individual Harmonics	
V1 Odd/even-harmonic distortion	V1 %HD1 - V1 %HD63
V2 Odd/even-harmonic distortion	V2 %HD1 - V2 %HD63
V3 Odd/even-harmonic distortion	V3 %HD1 - V3 %HD63
I1 Odd/even-harmonic distortion	I1 %HD1 - I1 %HD63
I2 Odd/even-harmonic distortion	I2 %HD1 - I2 %HD63
I3 Odd/even-harmonic distortion	I3 %HD1 - I3 %HD63
I4 Odd/even-harmonic distortion	I4 %HD1 - I4 %HD63
V1 Odd-harmonic voltage	V1 H01 - V1 H63
V2 Odd-harmonic voltage	V2 H01 - V2 H63
V3 Odd-harmonic voltage	V3 H01 - V3 H63
I1 Odd-harmonic current	I1 H01 - I1 H63
I2 Odd-harmonic current	I2 H01 - I2 H63
I3 Odd-harmonic current	I3 H01 - I3 H63
I4 Odd-harmonic current	I4 H01 - I4 H63
Three-phase total odd-harmonic kW	kW H01 - kW H63
Three-phase total odd-harmonic kvar	kvar H01 - kvar H63
Three-phase total odd-harmonic PF	PF H01 - PF H63
Symmetrical Components	
Positive-sequence voltage	V PSEQ
Negative-sequence voltage	V NSEQ
Zero-sequence voltage	V ZSEQ
Negative-sequence voltage unbalance	V NSEQ UNB%
Zero-sequence voltage unbalance	V ZSEQ UNB%
Positive-sequence current	I PSEQ
Negative-sequence current	I NSEQ
Zero-sequence current	I ZSEQ
Negative-sequence current unbalance	I NSEQ UNB%
Zero-sequence current unbalance	I ZSEQ UNB%
Fundamental Phasors	
Voltage magnitude	V1 Mag – V3 Mag
Current magnitude	I1 Mag - I4 Mag
Voltage angle	V1 Ang – V3 Ang
Current angle	I1 Ang - I4 Ang

The device provides individual voltage and current harmonic measurements both in percent of the

fundamental component, and in corresponding engineering units. Quantities in engineering units are calculated only for odd harmonics.

Angles for phasor vectors are given relative to the V1 phase voltage.

Aggregation Intervals

The device provides electrical measurements using a number of fixed aggregation time intervals from 1/2 cycle to 2 hours. The demand measurements use programmable aggregation intervals of up to 2.5 hours. The following table shows aggregation intervals available for different electrical quantities.

Parameter	1/2 cycle	1 cycle	200 ms	1 sec	3 sec	10 min	2 hours
RMS volts and currents	x	x	x	x	x	x	x
Powers		x		x	x		
Zero-sequence	x	x	x	x	x	x	x
Unbalance	x	x	x	x	x	x	x
DC Voltage	x	x	x	x	x	x	x
Frequency		x	x	x	10 sec	x	x
Total Harmonics/Interharmonics			x	x	x	x	x
Individual Harmonics			x				
K-factor			x	x	x	x	x
Crest factor			x		x	x	x
Symmetrical components			x			x	
Phasors			x				

The 200 ms RMS and unbalance quantities are integrated over a 10-cycle time for 50 Hz and 12-cycle time for 60 Hz power system. The data for the 3 sec time interval is aggregated from fifteen 200 ms time intervals. All RMS quantities aggregated from lower time intervals represent true RMS readings over the entire aggregation interval.

Demands

Demand measurements are provided for volts, amps, total harmonics and powers. Two different demand measurement techniques are used: block interval demand and sliding window demand.

Block Interval Demand

The block interval demand is calculated by aggregation of measurements over contiguous and non-overlapping fixed time intervals. Volts, amps and total harmonic demands are produced by averaging 1 sec RMS aggregates. Power demands are evaluated using integration of energies and averaging power over the demand time interval.

For volt, ampere and total harmonic demands, the demand period time is programmed from 1 second to 2.5 hours (see [Advanced Device Setup](#) in Chapter 6). For power demands, the demand period can be selected from 1 min to one hour.

Sliding Window Demand

The sliding window (rolling) demand technique is applied to power demands. The sliding window demand is calculated by averaging block interval demands over a number of adjacent demand intervals, which produce a sliding window. The number of time intervals for a sliding window can be selected from 1 to 15. When the present block demand interval expires, the sliding window moves one step forward by replacing the oldest entry with the most recent calculated block interval demand.

Accumulated and Predicted Demands

For power demands, the device provides an indication of two additional parameters: the accumulated block interval demand and predicted sliding window demand. Both accumulated and predicted demands can be effectively used for load shedding on the substation feeders.

The accumulated demand represents the relative energy accumulated from the beginning of the present demand interval and expressed in power units. It grows from zero at the beginning and up to the final block demand at the end of the demand interval. If the accumulated demand exceeds

the allowed demand at any point, the final block interval demand is more than the present accumulated demand (or equal if the load is disconnected).

The predicted demand shows the expected sliding window demand value at the end of the present demand interval, assuming that the load does not change. The predicted demand reflects load changes immediately as they happen.

Power demands are calculated for all device energy accumulators, including the Summary and TOU energy registers.

The following table shows demand quantities provided by the device.

Parameter	Block Demand	Sliding Demand	Accumulated Demand	Predicted Demand
Volt demands	x			
Ampere demands	x			
Voltage THD demand	x			
Current THD demand	x			
Current TDD demand	x			
kW demand (import and export)	x	x	x	x
kvar demand (import and export)	x	x	x	x
kVA demand	x	x	x	x
Summary energy demand (16 configurable registers)	x	x	x	

Maximum Demands

Every demand parameter is provided with the maximum demand register, which contains a time-stamped peak demand value recorded since the last reset. Maximum power demand registers are linked to the corresponding sliding demand source registers. If you wish to use block interval demands instead of sliding window demands as a source, set the number of the block intervals in the sliding window to 1.

For the TOU demand registers, the device allows automatic recording (profiling) of the daily and monthly maximum demands to the data log together with the TOU energy readings.

Energy Metering

The EM235/PM335 PRO provides true four-quadrant energy measurements for kWh imported and exported, kvarh imported and exported, and kVAh, with Class 0.2 ANSI C12-20:2015 or Class 0.2S IEC 62053-22:2003 accuracy. Net and total energy measurements for kWh and kvarh, and volt-hours and ampere-hours calculations are provided.

The device provides nine-digit energy counters by default. You can set the counters to have fewer digits by changing the default energy roll value in your device (see [General Setup Device Option](#) in Chapter 6).

Energy Pulses

The EM235/PM335 PRO outputs energy pulses through relay contacts with a user-selectable pulse rate (see [Producing Energy Pulses](#) and [Programming Relay Outputs](#) in Chapter 6). The pulse type (complete pulse or KYZ pulse), pulse width and polarity are freely programmable.

Energy Pulse LEDs

The EM235/PM335 PRO has one pulse LED on the front that provide energy pulsing for imported kWh or kvarh.

The LED pulse rate (pulse constant) is user-selectable (see [General Setup Device Option](#) in Chapter 6) and is programmed in secondary units. It does not depend on the ratings of the external transformers. The LED pulse rate is set at the factory to 0.1 Wh/pulse corresponding to one equivalent disk revolution.

The energy pulse LEDs are used for testing device accuracy by the external control equipment through pulse readers. In order not to affect the energy accumulators, the device should be put into the Energy Test Mode where the energy accumulators are disconnected from the power sources. Energy Test Mode also prevents erroneous setpoint operation and recording faults and power quality events when the test volts and currents are applied to the device. For information on entering the Energy Test Mode, see [Device Options Menu](#) in Chapter 3.

Summary Energy Registers

The EM235/PM335 PRO provides 16 summary (totalization) energy registers and 16 parallel demand registers that can be linked to any internal energy source, or to any external pulse source that delivers energy pulses through the device digital inputs (see Chapter 8 Totalization Energy and TOU Registers).

Each summary register can be configured to accumulate energies from multiple sources using arithmetic addition and subtraction. A summary register is allowed to be linked to another summary register to provide more comprehensive energy calculations.

Time-of-Use

The EM235/PM335 PRO TOU system handle a 10-year calendar with up to 16 types of days and up to eight tariff changes per day in each daily profile.

The device provides 16 TOU energy and 16 parallel maximum demand registers that receive data from the corresponding summary registers. Each TOU energy and TOU maximum demand register stores the accumulated energy and corresponding peak demands for up to 16 tariffs. See Chapter 8 “Totalization Energy and TOU Registers” for information on how to configure the TOU registers and define the tariff scheme in your device.

The device allows automatic daily and monthly profiling of the TOU energy readings and TOU maximum demands to the data log files. Data log files #15 and #16 are dedicated to the TOU system profile log and can be configured to automatically record TOU daily and monthly profiles (see Configuring Data Log Files in Chapter 7).

Instrument Transformer Correction

Ratio and phase angle error correction can be applied to external CTs and PTs to achieve overall metering installation accuracy, or be used in any metering installation to optimize the accuracy of the metering data.

The user can program up to both ratio correction and phase angle error curves covering the typical transformer operating range.

The EM235/PM335 PRO is able to calculate the transformer errors dynamically based on the transformer performance characteristics and the actual CT current and PT voltage signals appearing at the meter, to interpolate to the actual measured operating point and to apply the interpolated error corrections to the meter calculations.

See Instrument Transformer Correction Setup on how to program the ratio correction factors and phase angle errors for external CTs and PTs and enable correction in the meter. See Device Options how to enable and disable correction in the meter via the front display.

NOTES

3. When transformer correction is enabled, it is applied to all instrumentation, billing and power quality calculations and waveforms.
4. Transformer correction does not affect test LED pulse outputs.
5. Transformer correction is not operational in test mode regardless of the option's status.

Monitoring

Memory Backup Battery

The hardware circuit monitors the status of the memory backup battery. When the battery level drops below the minimum allowed threshold, the  icon on the display status bar will lit up, indicating that the battery should be replaced.

Logical Controller

The embedded logical controller allows monitoring any measured quantity or external contacts to provide indication, counting and recording events when the monitored value exceeds the predefined threshold or when status transitions are detected on the device inputs. See [Using Control Setpoints](#) in Chapter 6 for information on programming the logical controller.

The logical controller launches the Waveform recorder and Data recorder to record the input waveforms and measured quantities at the time of the event. Control setpoints can also be linked to the Event recorder to record setpoint transition events into the event log files.

Recording

Event Recorder

The Event recorder automatically records time-tagged self-supervision events related to configuration changes, resets and device diagnostics. The logical controller can also be programmed to trigger the Event recorder in order to put the events monitored through programmable setpoints into the event report. See [Configuring the Event Recorder](#) in Chapter 7 for more information on programming the Event recorder.

Power Quality Recorder

The EM235/PM335 PRO recorder continuously monitors voltage inputs and records time-tagged disturbances and faults into the power quality event log. All power quality triggers have programmable thresholds and can be adjusted for specific applications.

The Power Quality recorder is programmed to trigger the Waveform recorder and Data recorder to record input waveforms and long-duration RMS trends during the time of the disturbance. See [Configuring the Power Quality Recorder](#) in Chapter 7 for more information.

Device Diagnostics

Device diagnostic messages may appear as a result of the EM235/PM335 PRO built-in diagnostic tests performed during start-up and device operation.

All diagnostic events are recorded in the device Event log and can be inspected via PAS (see [Viewing the Event Log](#) in Chapter 13). The diagnostics status is also stored in a non-volatile register, which is not affected by loss of power and may be read and cleared via PAS, from the RDM, or from a user application. Refer to the EM235/PM335 PRO communication guides for the diagnostic register address and layout. See [Device Diagnostic Codes](#) in Chapter 20 for the list of diagnostic codes and their meanings.

Device failures are divided into three categories:

1. Non-critical intermittent faults with auto-reset. They do not cause the device to restart but may cause temporary degradation of device functionality. These faults are cleared automatically as the condition that caused the fault disappears.
2. Non-critical recoverable hardware or configuration faults with manual reset. These faults normally cause the device to restart followed by repairing of the configuration data. These faults must be cleared manually via PAS, from the RDM, or from a user application.
3. A critical unrecoverable hardware or configuration failure. The reason may be an unrecoverable sampling failure, or corruption of the time, the factory device configuration or the calibration setup data. A critical error causes the device to release all its outputs and to stop normal operation until the faults that caused the critical error are cleared.

Hardware failures are normally non-critical recoverable faults that do not cause a system failure but may cause data loss. Hardware failures are often caused by excessive electrical noise in the region of the device.

A configuration reset may also be a result of the legal changes in the device configuration whenever other configuration data is affected by the changes made.

In the event of a device fault, check the fault reason and clear the device diagnostics. If the reason is a time fault, update the device clock. In the event of a configuration reset, determine the device setup affected by the fault via the event log, and then verify the setup data.

See [Viewing and Clearing Device Diagnostics](#) in Chapter 10, [Viewing and Clearing Device Diagnostics](#) in Chapter 3, and [Status Information Display](#) in Chapter 3 on how to inspect and clear the device diagnostics status.

If the device continuously resets itself or an unrecoverable critical error occurs, contact your local distributor.

Device Fault Alarm

The EM235/PM335 PRO provides a global "DEVICE FAULT" event flag that is asserted all the time while one of the non-critical diagnostics events exists. It can be checked from a Setpoint (see Using Control Setpoints in Chapter 6) to give a fault indication via a relay output. If the alarm relay is programmed for failsafe mode using inverting polarity, then its normally closed contacts will be open if either the device loses power or a non-critical device fault occurs. Note that in the event of a critical system failure, all relay outputs are automatically released.

NOTE

The IRIG-B time faults may not be masked and may not be cleared externally. If the IRIG-B time code signal is not provided, set the device time synchronization input to any unused digital input (see [Local Settings](#) in Chapter 6) to avoid fault alarms caused by the IRIG-B port.

Meter Security

The PM335/EM235 PRO SERIES provides 3-level password security for protecting meter setups and accumulated data from unauthorized changes. Meter readings are not software protected.

Access to particular setup and control items is granted depending on the security level of the password you entered. The passwords can be 1 to 8 digits long.

The PM335/EM235 PRO SERIES is also equipped with terminal connections sealed cover to avoid unwanted electrical connections.

The following table shows the meter security levels and user access rights.

Table 5: Security Level and User access

Password	Security level	Access rights
Password 1	Low	Reset of billing and engineering maximum demands. Device diagnostics. Meter clock update. Display setup.
Password 2	Medium	TEST mode. Reset of pulse counters. Communications setup. I/O operation setup and control. Memory and recorders setup. Billing/TOU system setup.
Password 3	High (Administration level)	Meter passwords setup. Basic device setup. Device energy and power options setup. Reset of conventional log files.

Configuring Meter Passwords

PAS allows you to prepare and save the passwords in the meter site database and then download them at once to your meter or to multiple meters, or you can change any password individually online.

To configure passwords offline or to update them all together, select Administration Setup from the Meter Setup menu.

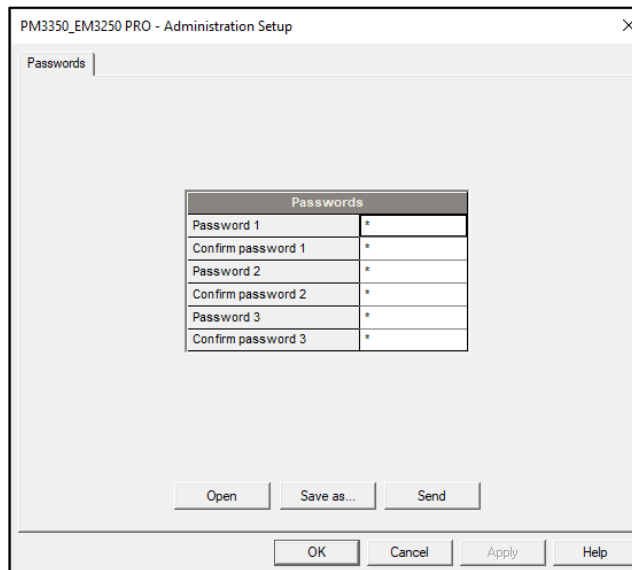

Figure 3-1: Administration Setup Box - Passwords Setup Tab

The present passwords settings are never uploaded from the meter via the Passwords setup. When you open the dialog, all passwords are zeroed.

To setup new passwords:

1. Enter the first (lower-level) password in the “Password 1” box and repeat it in the following “Confirm password” box.
2. In the same manner, enter Password 2 and Password 3 for the medium and high-level security passwords.
3. Click “Save as” to save the passwords to the site database. The passwords are stored in an encrypted form.
4. Click “Send” to update passwords in your meter.

To setup a password online:

1. From the Monitor menu, select Administration -> Change Password, and then click on the password you wish to change.

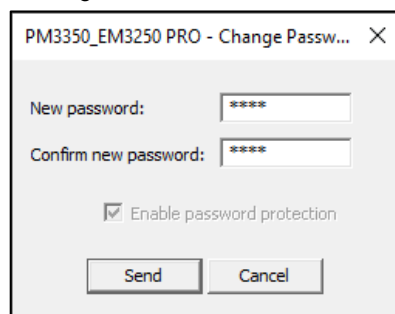

Figure 3-2: Administration Setup Box - Change Passwords

2. Enter the new password and repeat it in the following “Confirm new password” box.
3. Click Send to update the password in the meter.

5.

Chapter 4 Using Front Display

This chapter provides EM235/PM335 PRO Power Meter front panel information and operating procedures.



Figure 4-1a: PM335 PRO Unit

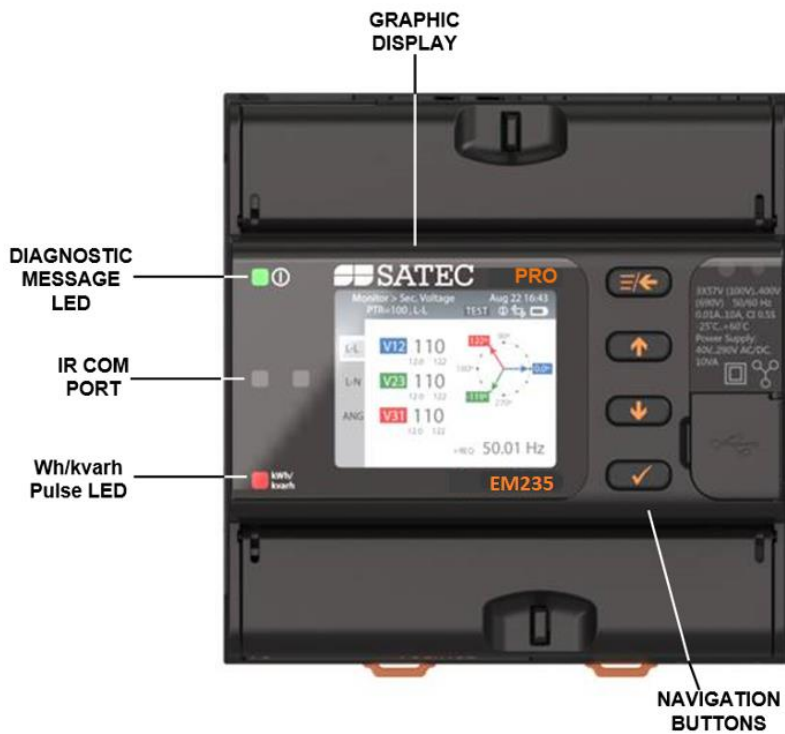

Figure 4-2b: EM235 PRO Unit

Display Operations

The EM235/PM335 PRO has a high-contrast graphical TFT LCD display for local data read outs, meter setup and servicing.





The display operates in two modes:

- Multi-page data display mode with Auto-Scroll feature allows you to scroll through display screens and pages to view various billing, instrumentation and status data.
- Programming mode allows you to enter menu-driven device setups for inspecting and changing factory set meter parameters, or resetting maximum demands, counters and device diagnostics messages.

The display is normally updated once per second.







Navigation Buttons

The EM235/PM335 PRO is provided with five/four navigation buttons as described below:

Button	Operation
	FAVORITE button in PM335 only: displays predefined favourite screens
	ESCAPE/MENU button: In menu screens - go one menu level up, until the main menu screen In configuration screens – exit screen without sending any value In editing fields - exit field editing without saving/sending the value In display screens – open menu, with the selected item that led to this display screen
	UP/DOWN buttons: In menu screens – go up and down over the open menu items, ignoring the level
	In configuration screens – scrolling the fields that are available for editing In editing fields – navigating up/down or right/left, incrementing/decrementing counters In display screens – scrolling through wrap-around the screens of the same level
	OK/ENTER button: In menu screens (not last level) – opens next level menu In menu screens (last level) – opens a corresponding display screen In configuration screens – enters field editing screen In fields editing screens – saves and sends value, closes fields editing screen, goes to parent configuration screen In display screens – enable favorite screens

Display Menus

The EM235/PM335 PRO has 6 multi-page displays listed in the following table.

Display Menus	Display Icon	Display Contents
Favourite		Displays predefined favorite screens
Monitor		Displays all electrical parameter values: V/I/P/Q/S/PF/Freq/I-O/Counters/Communication status
Consumption		Displays Electricity Energy/Gaz/Water consumption
Power Quality		Displays Real Time Waveform V/I, Harmonics V/I, Phasor and Trends
Logs and Reports		Displays Event logs and Diagnostics
Setup & Diagnostics		Device Setup screens and Diagnostics

Navigating using Display

The EM235/PM335 PRO provides, menu and submenu screens, multiple pages data displays. Your present location is indicated upper bar as shown in the following picture.

Navigating in Main Menu

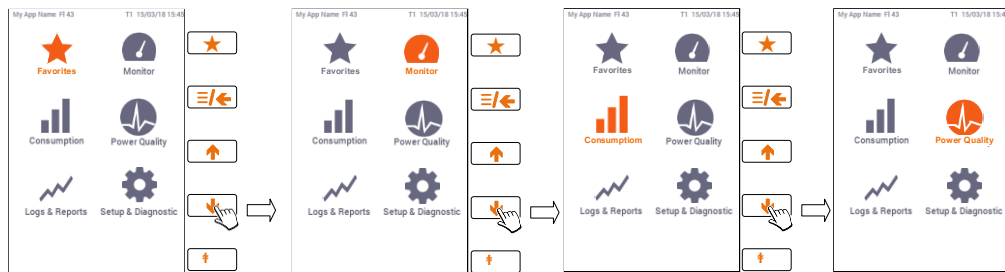

Figure 3: PM335 HMI Navigation

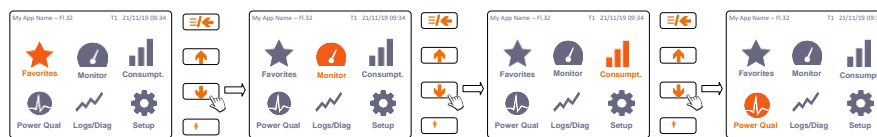
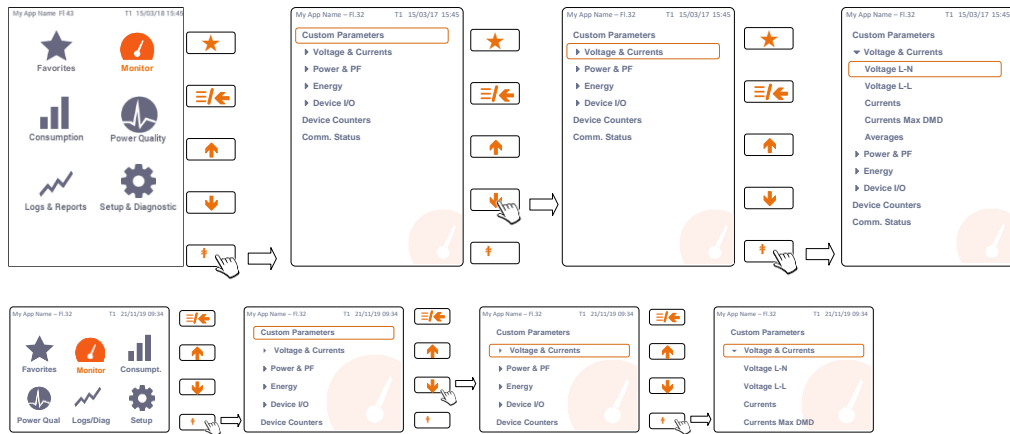

Figure 4: EM235 HMI Navigation

Navigating in Sub-Menu



Status Indicators

Graphical icons and indications on the top status bar give immediate meter status indication and show the present tariff rate.

The present date and time are indicated at right on the status bar. The date order can be changed according to local rules via the "Real Time Clock" device setup menu.

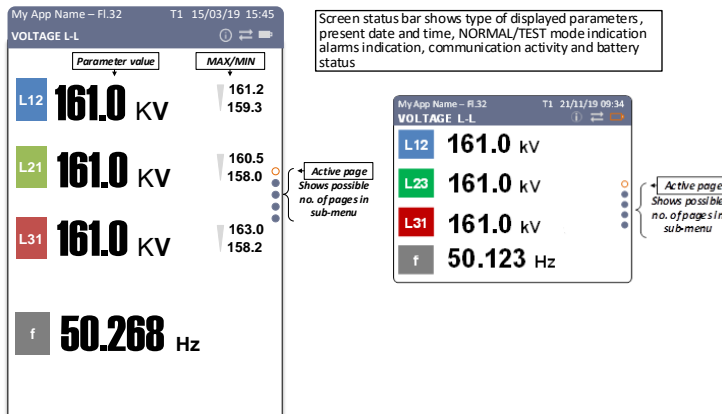

Use UP/DOWN scroll buttons to scroll through data displays.

Operating Mode Indicator

The mode indicator gives information on the load presence and shows the direction of active power.

Indicator Icon	Description
NORM	Normal mode
TEST	Test mode

Tariff Rate Indicator

The tariff rate indicator (T1 through T8) shows the currently active tariff rate.

Display Features

While energizing the device the display will show default screen line-voltages measurements as described below:

PM335 default. Screen

EM235 default. Screen

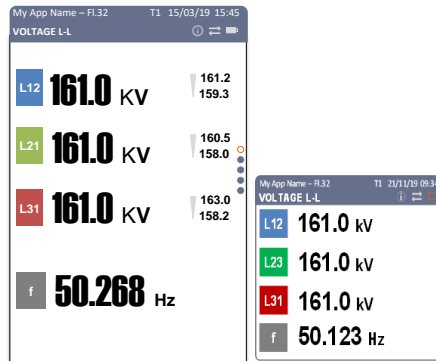

The default screen can be changed using the Display Setup Menu

Display Setup

The EM235/PM335 PRO display has a number of programmable features that can be disabled, enabled and adjusted via the meter Display Setup.

Using UP/DOWN/ENTER navigation buttons setup the desired display brightness and backlight time in the SETUP/Diag>Display Setup>Adjustment menu as described below:

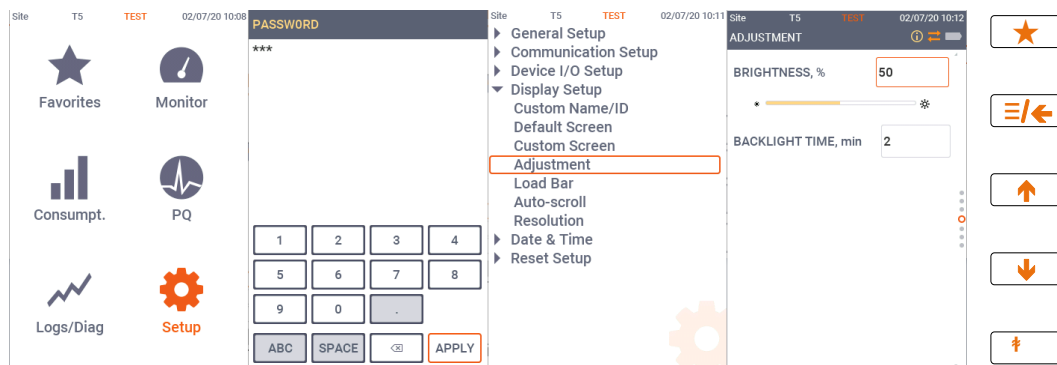

ⓘ Note:

The EM235 display menus is identical to the PM335 display menus

Display Adjustment - Backlight

The backlight stays on as long as you selected in the display setup and then dims to conserve power. The backlight time is factory set to 1 minute and can be programmed from 1 to 15 minutes.

Display Adjustment - Brightness

The contrast can be adjusted via the meter Display Setup

Display Measurement Units

The EM235/PM335 PRO has a selectable resolution and engineering units for volts, amps and powers presented on the front display and via communications.

Display Resolution

The resolution menu bestows the user to select number of decimal points for voltages, currents, power and energy monitoring values.

Phase Power Readings

In configurations with the neutral wire, in addition to total three-phase powers, the meter can show per-phase power readings. By default, they are disabled. See [Configuring the Display](#) on how to enable per-phase power readings in your meter.

Fundamental Component

The EM235/PM335 PRO can display total displacement power factor and active power for the fundamental component if it is enabled through the display setup (see [Configuring the Display](#)).

When phase power readings are allowed, the EM235/PM335 PRO also displays per-phase displacement power factor and active power for the fundamental component.

TEST Mode Data Display

The TEST data display is shown in TEST mode in place of the billing period data displays.

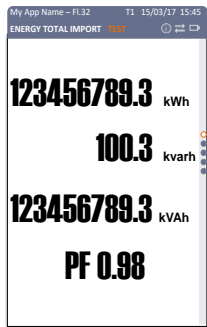
	<p>TEST mode display:</p> <ul style="list-style-type: none"> test LED pulse rate in secondary Wh/imp; test kWh and kvarh energy readings in primary units with an extended 0.001 kWh resolution. <p>TEST mode setup menu is enabled in Device Setup/Device Options menu.</p>
--	--

Monitor Display

The Monitor Display menu consists of monitoring electric parameters, device resources status, communication status and device diagnostics as described in table below.

Display Menus	Display Contents
Custom Parameters	Predefined screen that shows the custom parameters
Voltage & Currents	Displays all voltage & current parameter values
Power % PF	Displays all powers & power factor values
Device I/O	Displays digital inputs status, relay outputs status and analogue inputs/outputs
Device Counters	Displays counters value
Communication Status	Displays COM1-4 status, ETH1-2 IP address

Instrumentation Data Display

Measurements data represent general instrumentation data you can use while installation and inspecting the meter. Use phase angles displays to check the order of phases when connecting wires to the meter terminals. Use the UP/DOWN button to scroll to the desired data display

Custom Parameters

The custom parameters menu displays up to 4 predefined parameters to be seen in one single display. This custom display can be setup as default screen.

Access Monitor from main menu, using the UP/DOWN button select Custom Parameters and press OK/ENTER button to display the custom parameters screen.

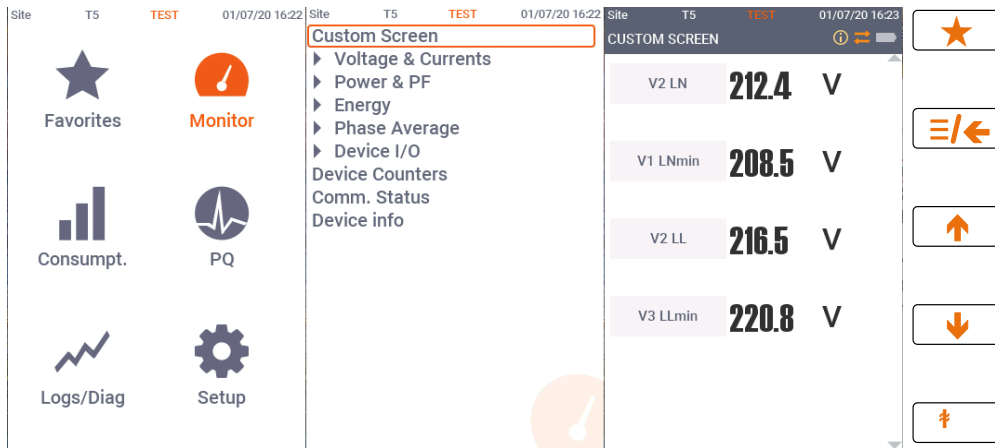

Note:

The EM235 display menus is identical to the PM335 display menus

Voltage and Currents

Access Monitor from main menu, using the UP/DOWN button select Voltage & Currents/Voltage L-N and press OK/ENTER button to display the line-to-line voltage measurement screen, using UP/DOWN button select the desired voltage/current parameter to display

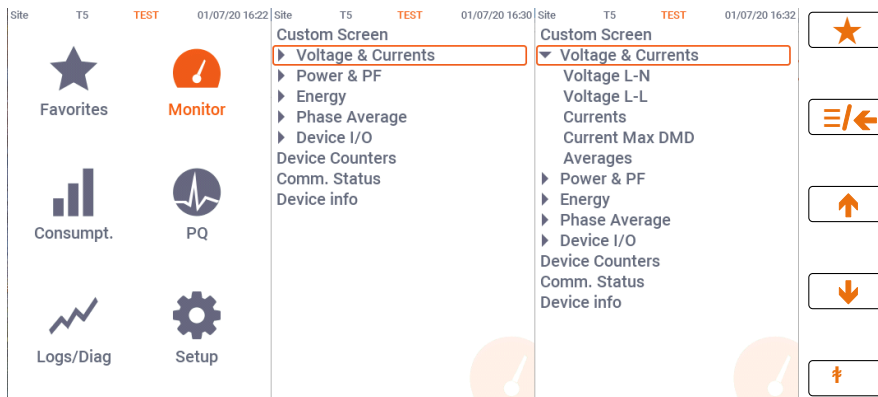

Note:

The EM235 display menus is identical to the PM335 display menus

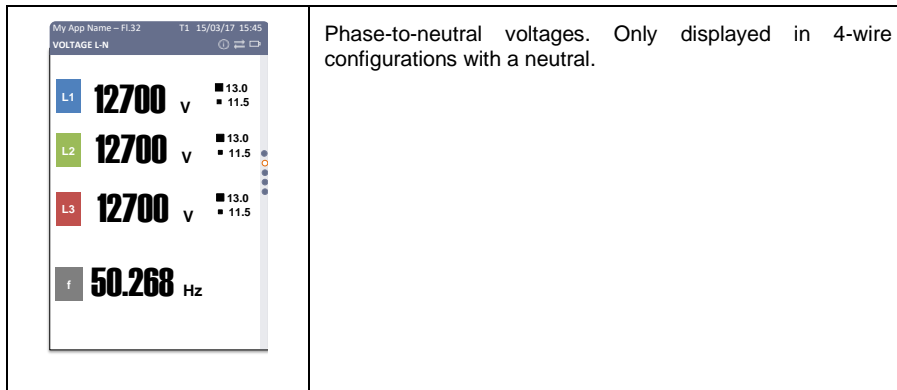

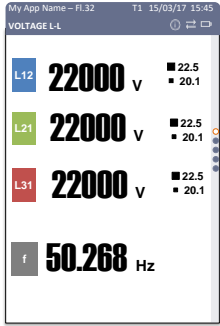
	<p>Phase-to-phase voltages</p>
	<p>Phase and neutral currents</p>
	<p>Phase and neutral currents maximum demand with time stamp</p>
	<p>Average phases V/I/P/PF</p>

Power and PF

Access Monitor form main menu, using the UP/DOWN button select POWER & PF/Min/Max/Phase 1 and press OK/ENTER button to display the phase 1 min/max power measurement screen, using UP/DOWN button select the desired power & pf parameter to display

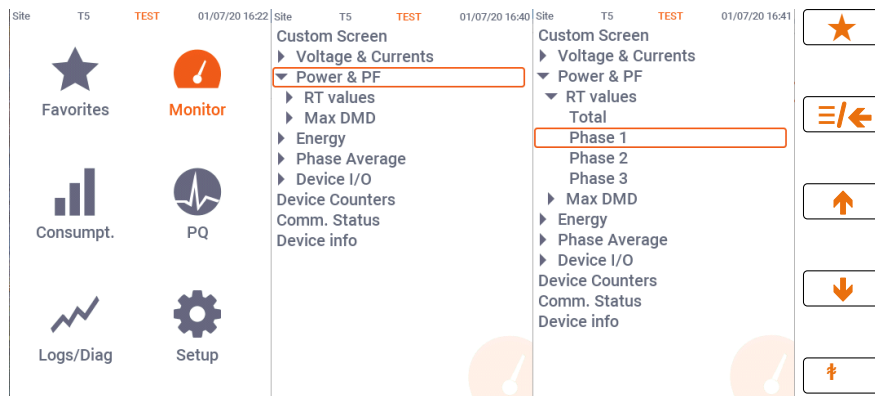

Note:

The EM235 display menus is identical to the PM335 display menus

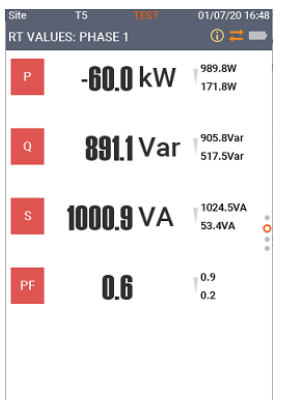
	MIN/MAX Phase 1 powers and power factor
	MIN/MAX Phase 2 powers and power factor
	MIN/MAX Phase 3 powers and power factor
	MIN/MAX Total powers and power factor
	Maximum Demand Phase 1 powers and power factor
	Maximum Demand Phase 2 powers and power factor
	Maximum Demand Phase 3 powers and power factor
	Total powers maximum demand

Measurements Energy Data Display

Energy displays show measurements total import/export for energy and phases energy. Use the UP/DOWN button to scroll to the desired energy data display

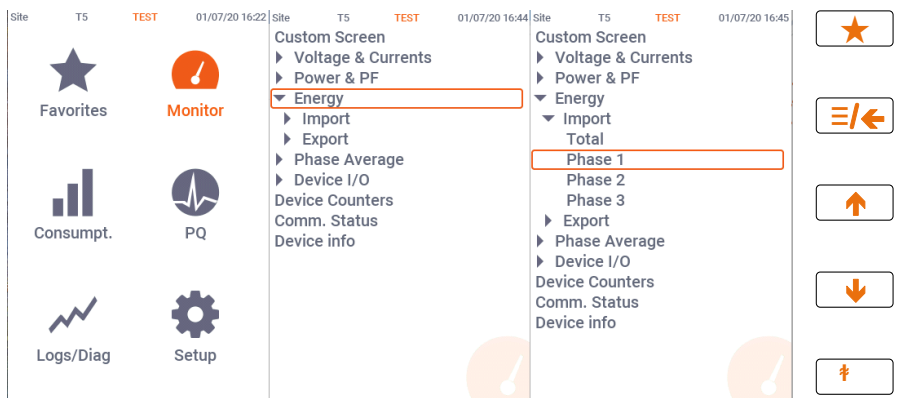

Note:

The EM235 display menu is identical to the PM335 display menus

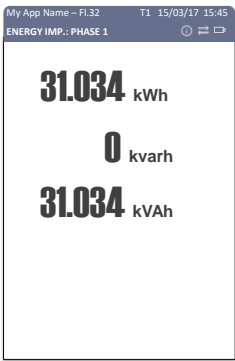
	Phase 1 import energy.
	Phase 2 import energy.
	Phase 3 import energy.
	Total import energy.
	Phase 1 export energy.
	Phase 2 export energy.
	Phase 3 export energy.
	Total export energy.

Device I/O

The Digital I/O display shows three sub-menus: "Digital Inputs" display to show status of each digital input, "Pulse/Event Counters" display to count external pulses or setpoint events, or as time counters to count setpoint operation time, "Relay Outputs" display to show status of each relay output. Use the UP/DOWN button to move from one display to another.

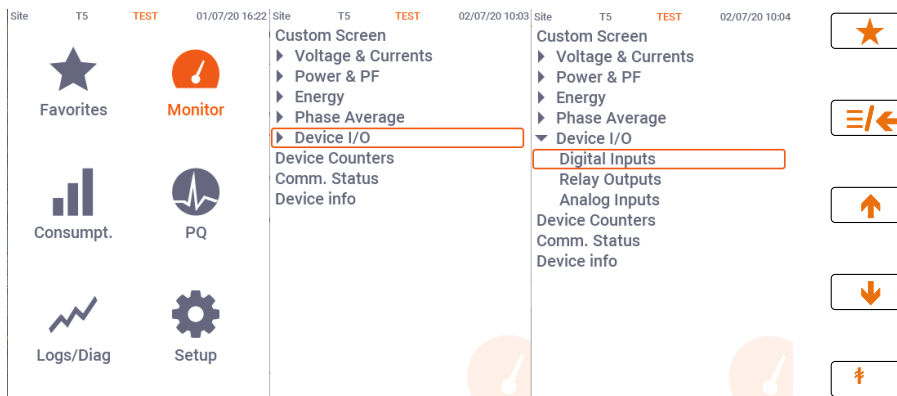

Note:

The EM235 display menu is identical to the PM335 display menu

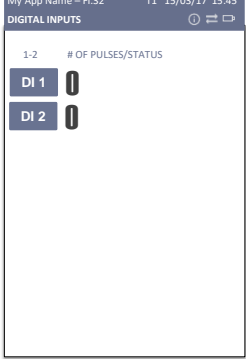
	<p>Digital Inputs status</p>
	<p>Relay outputs status</p>
	<p>Analog inputs</p>

Device Counters

The Device Counters display shows three sub-menus: "Digital Inputs" display to show status of each digital input, "Pulse/Event Counters" display to count external pulses or Setpoint events, or as time counters to count Setpoint operation time, "Relay Outputs" display to show status of each relay output. Use the UP/DOWN button to move from one display to another.

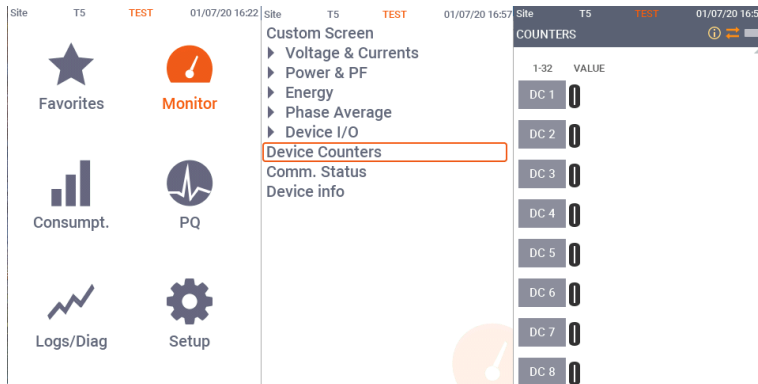

Note:

The EM235 display menus is identical to the PM335 display menus

Communication Status

Access Monitor form main menu, using the UP/DOWN button select Comm. Status and press OK/ENTER button to display the device communications ports status

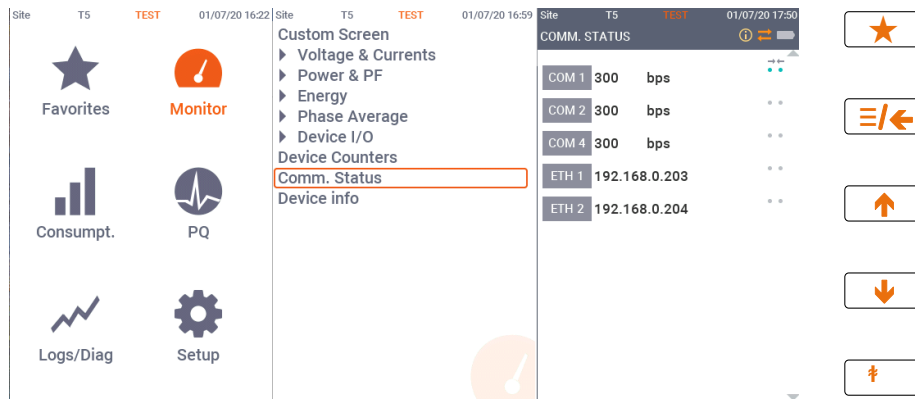

Note:

The EM235 display menus is identical to the PM335 display menus

Consumption Display

Billing Period Data Displays

The EM235/PM335 PRO provides billing period data displays for energy and general purpose volume data as m³, cf or Ccf calculated using Digital Input for water and/or gas meter application.

Only registers you selected in the billing/TOU register setup and tariff rates listed in the TOU daily profiles are included (see [Configuring Billing/Tariff Registers](#) and [Configuring the Daily Tariff Schedule](#) in Chapter 5).

The following example demonstrates the present billing period displays for two configured billing registers (kWh imported and kvarh imported) and for three active tariff rates. The actual register contents in your installation may be different depending on your selection of register sources.

	<p>Register 1 - total readings: Total Import Active energy data (in this case for Phase 1).</p> <p>Billing period according to TOU predefined profile (Reg1 for TOU active energy and Reg2 for TOU reactive energy are predefined TOU/Register factory setup, can be changed by user, see Configuring Billing/Tariff Registers and Configuring the Daily Tariff Schedule in Chapter 5)</p> <p>Register 1 – tariff 1 readings: Total Import Active energy data.</p> <p>Register 1 – tariff 2 readings: Total Import Active energy data.</p>
	<p>Register 2 - total readings: Total Export Active energy data.</p>
	<p>Register 2 – tariff 1 readings: Total Export Active energy data.</p>
	<p>Register 2 – tariff 2 readings: Total Export Active energy data.</p>

Each billing period display lists all total and tariff energy, maximum demand and cumulative maximum demand registers for all configured billing registers and all active tariffs. Use the

	Register 3 - total readings: Total Import Reactive energy data
	Register 3 – tariff 1 readings: Total Import Reactive energy data.
	Register 3 – tariff 2 readings: Total Import Reactive energy data.
	Register 4 - total readings: Total Export Reactive energy data
	Register 4 – tariff 1 readings: Total Export Reactive energy data.
	Register 4 – tariff 2 readings: Total Export Reactive energy data.

UP/DOWN/ENTER button to navigate to the desired Billing/TOU period register display

Power Quality Display

RT Waveform Display

The waveform display shows per-phase voltage and current waveforms and V/I values + THD. Use the UP/DOWN button to scroll through the phases.

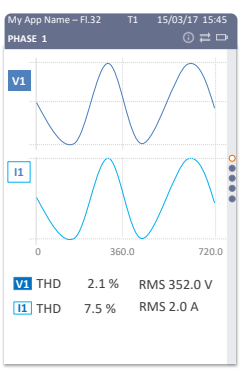
	<p>Phase 1 voltage and current real time waveforms, showing V&I THD</p>
	<p>Phase 2 voltage and current real time waveforms, showing V&I THD</p>
	<p>Phase 3 voltage and current real time waveforms, showing V&I THD</p>
	<p>3 phase voltage real time waveforms, showing V1-V3 THD</p>
	<p>3 phase current real time waveforms, showing I1-I3 THD</p>

Harmonics Display

Harmonics display shows individual harmonics distortion for phase voltages and current, and phase voltage/current harmonic spectrum graphs. Use the UP/DOWN button to scroll to the specific harmonic number or voltage and current channels harmonic spectrum.

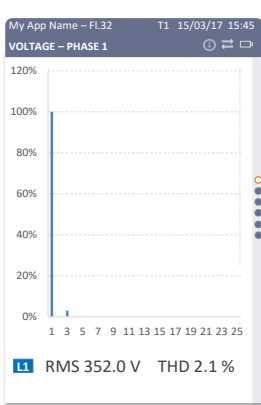
	<p>phase voltages and currents harmonics spectrum, %</p>
---	--

Phasor Display

The Phasor display shows a three-phase network Phasor diagram. All phase angles are given relatively to the V1 channel.

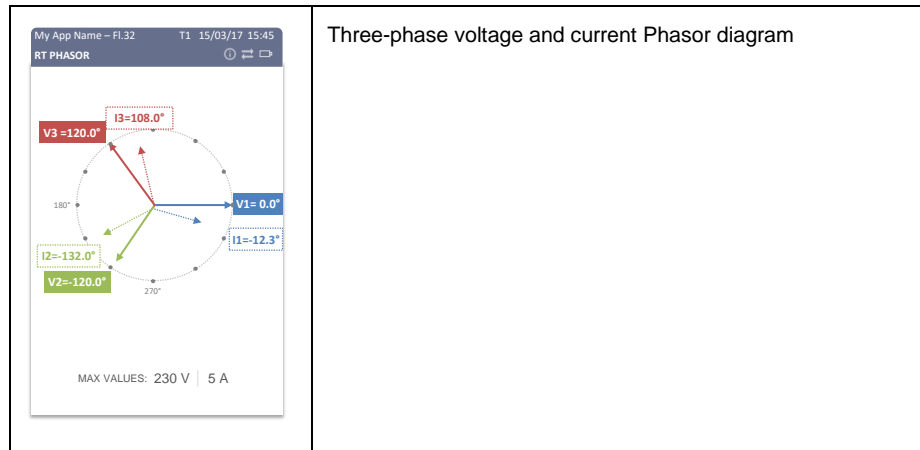

Trend Display

The Trend Display shows basic parameters trend – Voltage, Current, Power and Frequency

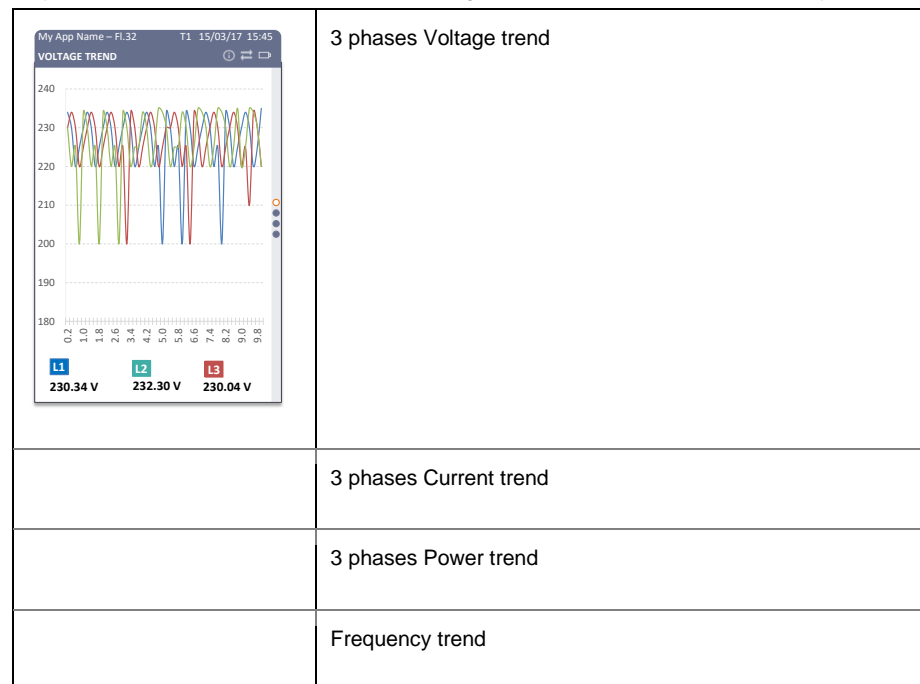

Load Bar Graph

The load bar graph displays the amount, in percent (40% to 110%), of the present current load with respect to user-defined nominal load current. The reference nominal current can be set up in amps through the display setup. If it is set to 0 (default), the current load is referenced to the specified CT primary current.

Energy Pulse LED

The EM235/PM335 PRO have a red “Energy Pulse” LED. It flashes at a constant rate when a load is applied to the meter.

There are two modes of LED operation:

- NORMAL mode: the LED pulses indicate imported Wh at a rate of 1,000 pulses per kWh

- TEST mode: the LED pulses indicate either imported Wh, or imported (inductive) varh at a rate of 10,000 pulses per kWh/kvarh

The energy test mode can be enabled through the [Device Options](#) setup. When in test mode, the energy and demand accumulators do not account for consumed energy.

Logs and Diagnostics display

The device Logs and Diagnostics display shows two sub-menus: "Alarms/Event Log" and "Diagnostics".

The diagnostics display shows device diagnostic messages recorded as a result of the meter self-test diagnostics during start-up and operation, the alarm display shows a list of operated alarm setpoints along with the alarm trigger labels if there are alarms recorded during meter operation.

Alarms/Event log

The Alarms/Event log display shows the device events caused by external cause as setup changes, memory clear operation, power outages. Every alarm/events is marked with time stamp showing the alarm/event time occurrence.

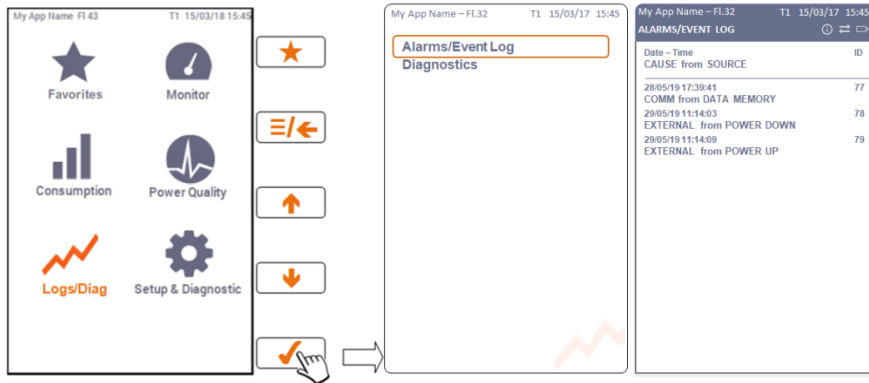

Note:

The EM235 display menus is identical to the PM335 display menus

Diagnostics

If there are diagnostic messages, the diagnostic green led on the device panel flashes until you clear the device diagnostics. Some of the diagnostics events are cleared automatically as the event source disappears. See [Device Diagnostic Codes](#) in Chapter 20 for a full list of diagnostic messages and their meanings. See [Clearing Device Diagnostics](#) for information on how to clear the device diagnostics from the display and via PAS.

The diagnostic Led indication can be disabled or enabled via the [Display Setup](#) menu. The Diagnostics display shows the device faults as described in the [Device Diagnostic codes](#)

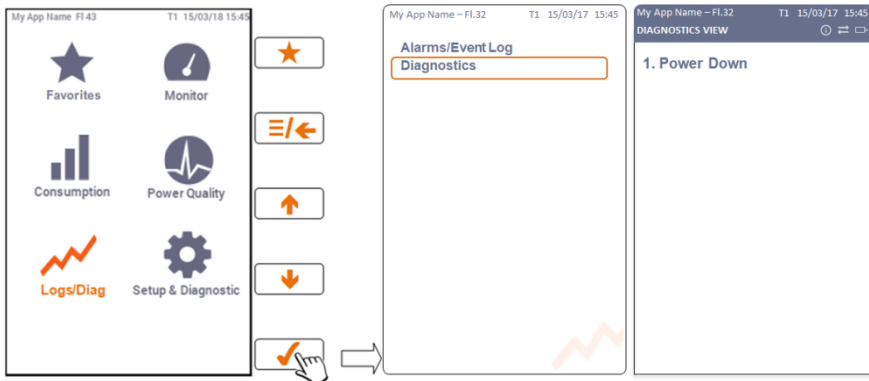

Note:

The EM235 display menus is identical to the PM335 display menus

Device Setup

The EM235/PM335 PRO setup is menu-driven. The device provides 12 menus that allow local accessing a limited number of meter setups and control functions listed in the following table. Access to particular menus is granted depending on the password you entered if enabled.

Menu Label	Menu Function
General Setup	Basic device setup, Demand setup, TDD, Device options, Transformer correction, Digital inputs, Relay outputs and Counters
Communication Setup	COM1,2 and 3 serial port setup, Network 1 & 2 setup, Dial-up network setup
Display Setup	Custom name/ID setup, Adjustment setup, Localization details, Localization DST, Engineering units and Resolution setup
TOU display setup	TOU source setup, Billing period display setup
Custom setup	Default page, Custom parameters page setup
Reset Setup	Reset of engineering maximum demands, Counters, logs, energy and Billing/TOU energy

Entering the Password

The Setup Change menu can be secured by up to eight-digit user password.

You can change the password and enable password protection through the Access Control menu. The meter is primarily shipped with the password preset to 0 and password protection disabled.

If password protection is enabled, you are prompted for a password when entering the setup change menu.

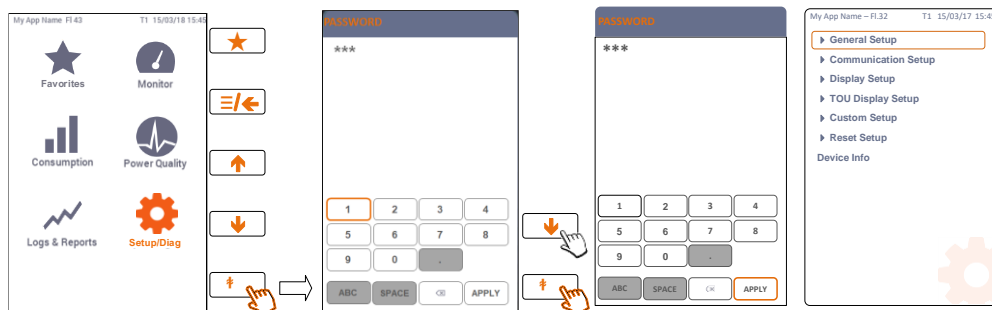

Note:

The EM235 display menus is identical to the PM335 display menus

If the password you entered is correct, you are moved to the Main menu, otherwise you return back to the Device Setup menu.

Viewing and Changing Setup Options

Once you entered a correct password you are moved to the Device Setup menu.

The Device Setup menu consists of sub-menus list.



To select a desired menu entry from the menu list:

Use the UP/DOWN button -   to scroll through the menu list to the desired menu entry

Press the ENTER/OK button -  to enter the selected submenu.

Parameters that are represented by values can be changed in two ways:

- By pressing the ENTER/OK button - , a new sub-menu appears by presenting possible values to be selected

Use the UP/DOWN button -   to scroll through the desired value, then press the ENTER/OK button -  to store the selected value

Note: While being in the Device Setup operation mode, the EM235/PM335 PRO display will return to normal operation, i.e. move to data display, during idle operation of one minute

Chapter 5 Using PAS Software

The support PAS software is a configuration and data acquisition tool that allows you to configure all of the EM235/PM335 PRO features, monitor your meters on-line, retrieve recorded files and view reports. PAS can communicate with your EM235/PM335 PRO via a serial port and via the Ethernet.

This chapter gives information on how to install and run PAS on your computer, and how to prepare information for your meter using PAS.

See Chapter 5 [Configuring the EM235/PM335 PRO](#) for instructions on how to configure particular features in your meter. Refer to Chapters 7 and 8 for instructions on retrieving data from the meters and viewing reports.

Installing PAS

You need PAS V1.53 or higher to take an advantage of the meter data logging options.

To install PAS on your PC:

1. Insert the installation CD supplied with your meter into CD drive.
2. Open My Computer on your Desktop.
3. Click on your CD drive icon, select the PAS directory, and then double click on Setup (shown as an Application type file).
4. Follow InstallShield® Wizard instructions on the screen.

PAS is installed by default to the C:\Pas folder.

When installation is complete, the PAS icon appears on your Desktop. Double click on the PAS icon to run PAS.

For general information on how to work with PAS, see the "PAS Getting Started" guide supplied on the installation CD.

Creating a New Site for your Meter

PAS keeps all communication and configuration data for your meter in a configuration database called a site database. During configuration, store all setup data to the site database so that PAS recognizes device properties regardless of whether the meter is online or offline.

To communicate with the meters, create a separate site database for each device.

To create a new database for your meter:

1. Select Configuration from the Tools menu.

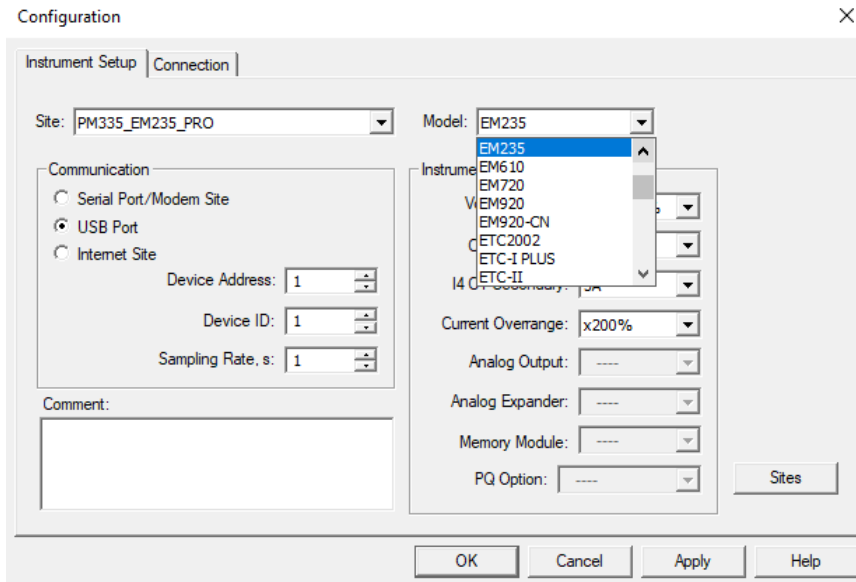
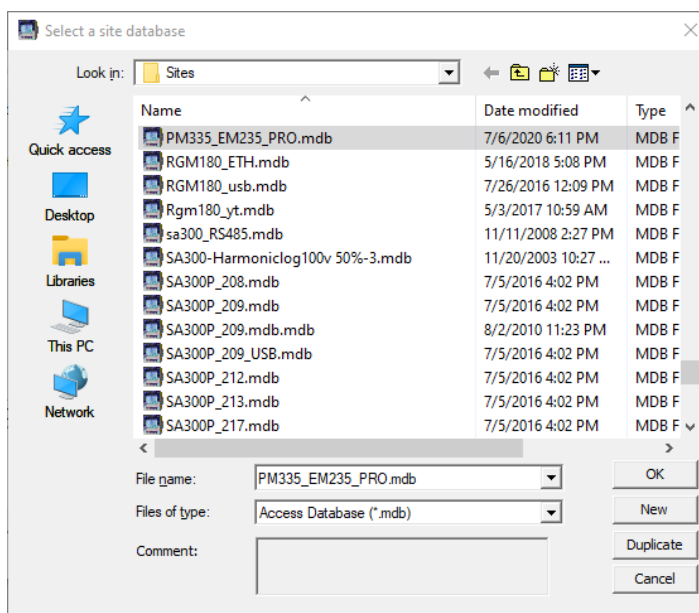

Figure 5-1: Configuration Dialog Box – Instrument Setup Tab

2. Click the Sites button on the right-hand-side.



3. From the Look in box, select the directory where a new database will be stored. By default, it is the Sites directory.
4. Type a site name for your device in the File name box, click New, and then click OK.
5. On the Instrument Setup tab, select PM335 or EM235 PRO in the Model

- box. PAS automatically selects the appropriate instrument options for your meter.
6. Select a correct CT secondary current (5A or 1A) for your meter.
 7. If you wish to add any comments for your meter, type the comments in the Comment box.

Setting up Communications

You can communicate with the EM235/PM335 PRO via a PC RS-232 serial port or through the Internet.

To configure communications with the EM235/PM335 PRO:

1. Select Configuration from the Tools menu. Under the Communication group on the Instrument Setup tab, select the type of connection for your device.
2. Set the device communication address you assigned to the EM235/PM335 PRO port. When communicating via the Ethernet, the EM235/PM335 PRO responds to any address you select.
3. In the Sampling Rate box, select a rate at which PAS updates data on your screen when you continuously poll the device in the PAS Data Monitor.

The communication protocol and port settings must match the settings you made in your meter.

Communicating through a Serial Port

Select Serial Port/Modem Site on the Configuration tab, and then click on the Connection tab to configure your serial port settings.

Configuring a Serial Port

1. On the Connection tab, select a COM port from the Device box, and then click Configure.

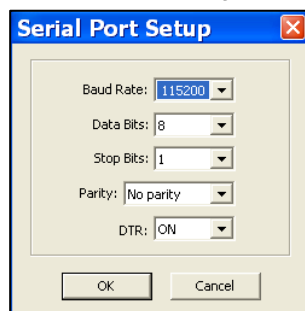

Figure 5-2: Serial Port Setup Dialog Box

2. Specify the baud rate and data format for the port. Choose the same baud rate and data format as you have set in the meter, and then click OK.

The factory settings for the local EM235/PM335 PRO RS-232 and RS-422/485 ports are 9600 baud, 8 bits with no parity.

Selecting the Communications Protocol

1. On the Connection tab, click Protocol.

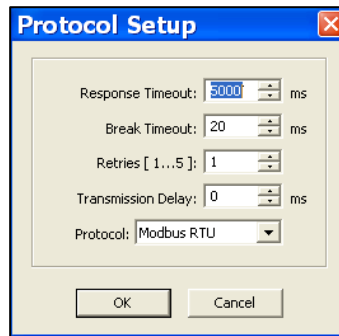

Figure 5-3: Protocol Setup Dialog Box

2. In the Protocol box, select the same communications protocol as you have set in your meter.
3. In the Response Timeout box, define the maximum time that PAS should wait for the meter response before announcing a failure.
4. In the Break Timeout box, define the maximum line idle time that PAS should wait after receiving the last message character before closing a connection with the Modbus RTU or DNP3 protocol. It does not affect ASCII communications. Note that this time is added to the message transfer time, and excessive increasing it may slow down communications. If you frequently receive the "Communication error" message, try to increase Break Timeout.
5. In the Retries box, define the number of attempts that PAS should use to receive a response from the meter in the event the communication fails, before announcing a communication failure.

Communicating through the Internet

If you are communicating through the Ethernet port, define the IP address of your meter on the network.

To configure the meter IP address:

1. On the Instrument Setup tab, select Internet Site.
2. Click on the Connection tab.
3. Click on the IP address and type in the IP address of your meter. The default IP address preset in the meter at the factory is 192.168.0.203.
4. In the Protocol box, select the communications protocol for the TCP port. The meter provides Modbus/TCP connections on TCP port 502 and DNP3/TCP connections on port 20000. The host port is set automatically as you select the protocol. Select Modbus RTU/TCP for Modbus/TCP or DNP3 for DNP3/TCP.
5. In the Wait for answer box, adjust the time that PAS waits for a connection before announcing an error.

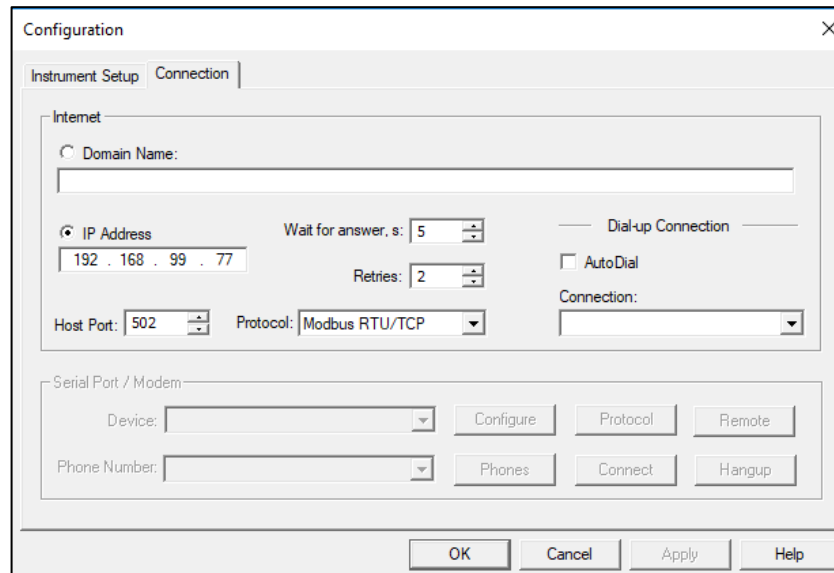

Figure 5-4: Configuration Dialog Box – Connection Tab

6. In the Retries box, specify the number of retries PAS will use to receive a response from the meter if communications fail.
7. Click OK.

Setting Up the Meter

Preparing Setups for the Meter

PAS allows you to prepare setup data for your meter off-line without the need to have it connected to your PC.

To prepare a setup for your meter:

1. Select the device site from the list box on the PAS toolbar.
2. Select the desired setup group from the Meter Setup menu. Click on the tab with the setup you want to create or modify.
3. Fill in the boxes with the desired configuration data for your meter.
4. Click the Save as... button to store the data to the meter site database.
5. Click OK.



Always set up and store the Basic Setup data to the site database first. PAS uses this data as a reference when arranging other meter setups.

To save your setup to another site database:

1. Click the Save as... button.
2. Select the target database from the file pane.
3. Click OK.

You can also reuse a setup from another site by copying it to your present site database.

To copy a setup from another site's database:

1. Click Open.
2. Select the desired source site database.
3. Click OK. The opened setup is copied to your dialog window.
4. Click the Save as... button.
5. Select the target database from the file pane.
6. Click OK.

To copy all setups from one site database to another site's database:

1. In the list box on the toolbar, select a source device site from which you wish to

- copy setups.
2. Select Copy to... from the Meter Setup menu.
3. Select the target site database to which you wish to copy setups, and click OK.

Downloading Setups to the Meter

You can update each setup in your meter one at a time or download all setups together from the site database.

Individual Download

To update a particular setup in your meter:

1. Check the On-line button on the PAS toolbar
2. Select a meter site from the list box on the toolbar.
3. Select the desired setup group from the Meter Setup menu. Click on the setup tab you want to download to the meter. As the setup dialog box opens, PAS retrieves and displays the present meter setup data.
4. If you wish to download a setup saved in the site database, click Open, and then click OK, or fill in the boxes with the desired configuration data for your device.
5. Click Send.

Batch Download

To download all setups to your device at once:

1. Check the On-line button on the PAS toolbar
2. Select the device site from the list box on the toolbar.
3. Select Download Setups from the Meter Setup menu.

Uploading Setups from the Meter

Individual Upload

To get a particular setup from your device:

1. Check the On-line button on the PAS toolbar.
2. Select a meter site from the list box on the toolbar, and then select the desired setup group from the Meter Setup menu.
3. Click on the tab of the setup you want to read from the meter. As the dialog box opens, PAS retrieves and displays the present setup data from the meter. Click Receive if you wish to retrieve the meter setup once again.
4. To store the setup to the meter site database, click Save As, and then click OK.

Batch Upload

To upload all setups from the device to the site database at once:

1. Check the On-line button on the toolbar.
2. Select the device site from the list box on the toolbar.
3. Select Upload Setups from the Meter Setup menu.
- 4.
- 5.
- 6.
- 7.
- 8.
- 9.

Authorization

If communications with your meter is secured, you are prompted for the password when you send new setup data to the meter.

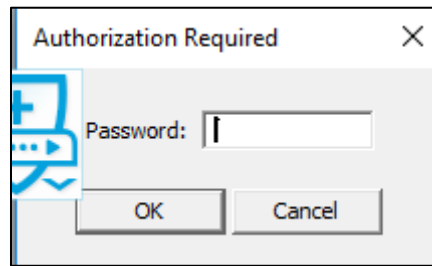

Figure 5-5: Authorization Dialog Box

- Enter the password and click OK.

If your authorization was successful, you are not prompted for the password again until you close the dialog box.

See [Configuring Meter Security](#) in Chapter 5 for more information on the meter password security.

Upgrading Device Firmware

Your meter has upgradeable firmware. If you need to upgrade your device, download a new firmware file to the meter through PAS.

Firmware can be downloaded via the Modbus RTU or Modbus/TCP protocol through any communication port.

To download a new firmware file to your device:

1. Ensure that the communication port you are connected through to the meter operates in Modbus mode.
2. If you are connected to the meter through a serial interface, it is recommended to set the port baud rate to 115,200 bps. See [Setting Up Serial Communication Ports](#) on how to remotely change the protocol and baud rate in your meter.
3. Ensure that the On-line button on the PAS toolbar is checked, and then select Flash Downloader from the Monitor menu and confirm downloading.
4. Point to the firmware upgrade file for your meter, click Open, and then confirm upgrading the meter.

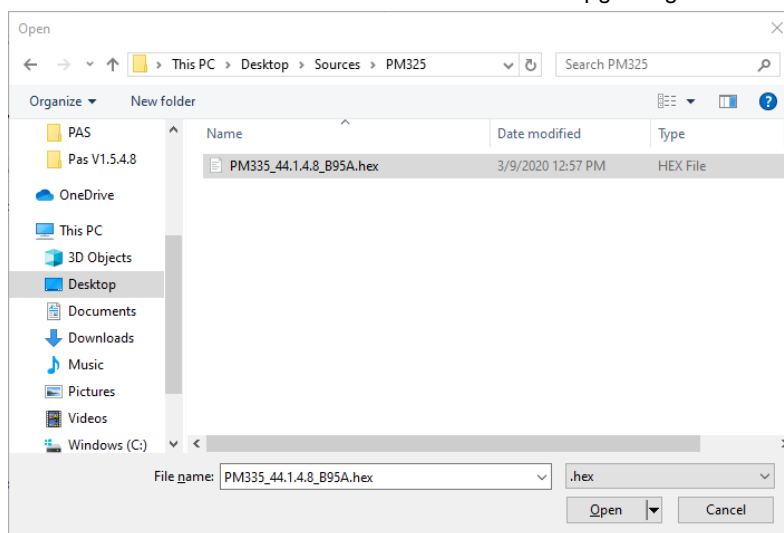
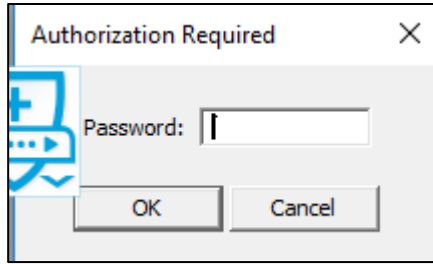
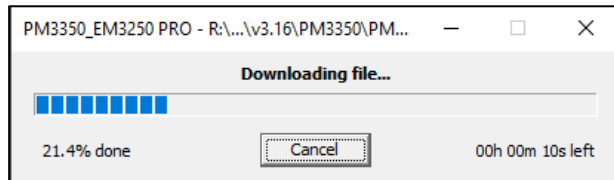

Figure 5-6: selecting the firmware file for upgrading

- 5. You are asked for the password regardless of the password protection setting in your meter. Type the meter password, and click OK. If you did not change the password in the meter, enter the default password 0.



- 6. Wait until PAS completes upgrading your device. It takes about 3-4 minutes at 115,200 bps to download the file to the meter.



- 7. After upgrading firmware is completed, the meter restarts, so communications can be temporarily lost. You may need to wait a short duration until PAS restores a connection with your device.

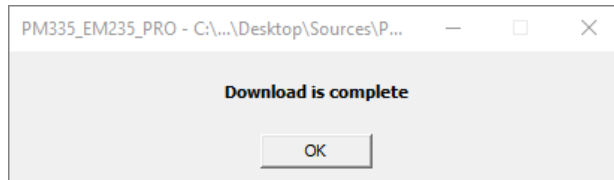

Chapter 6 Configuring the EM235/PM335 PRO

This chapter describes how to configure different options in your meter from the front panel display and via PAS.

Configuring Communications

Setting Up Serial Communication Ports

Using the Front Display

Access Communication Setup menu, Select COM1 or other and setup the communication port desired parameters as described below using UP/DOWN navigation button and OK/ENTER button.

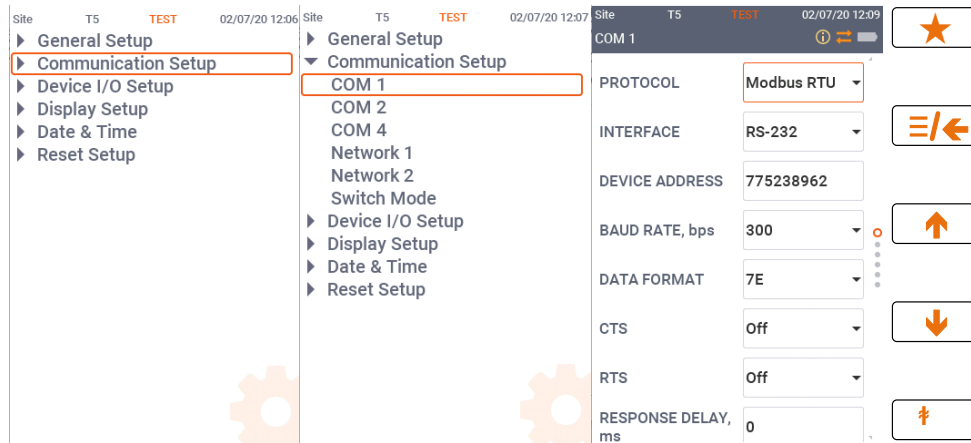

Note:

The EM325 display menus is identical to the PM335 display menus

Using PAS

Select Communications Setup from the Meter Setup menu, and then click on the Serial Ports Setup tab. In the Port box, select the desired device port.

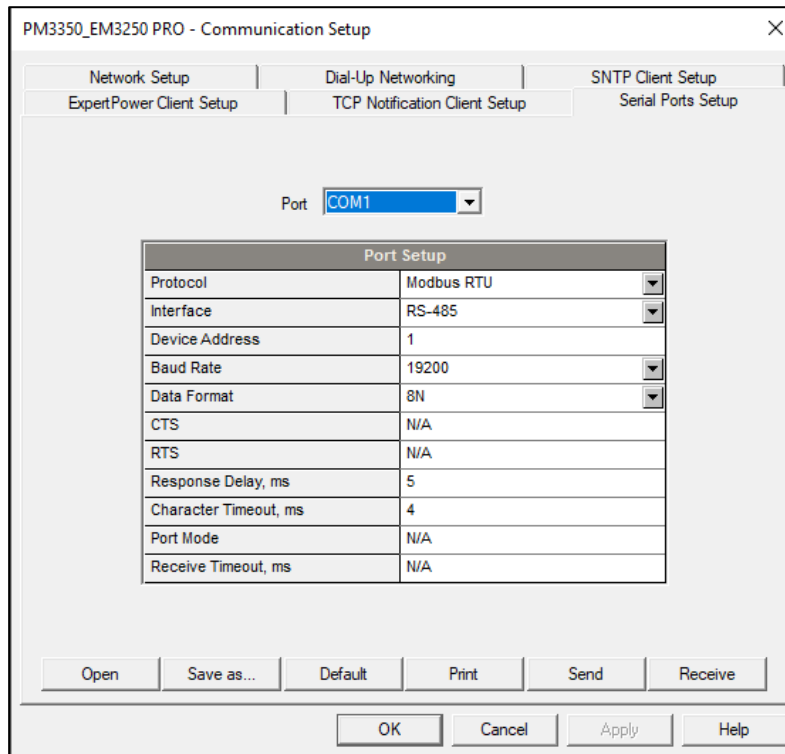

Figure 6-1: Communication Setup Dialog Box – Serial Ports Setup Tab

See Table 6 below for available communication options.

Table 6: COM Port Options

Parameter	Options	Default	Description
Protocol	MODBUS RTU DNP3 IEC 62056-21 IEC 60870-5	MODBUS RTU	The communications protocol for the port
Interface	COM1, COM2: 485 = RS-485	RS-485	Communication interface. COM2 is available on add-on module only.
Device address	MODBUS: 1-247 DNP3: 0-65532	1	Device network address
Baud rate	300 bps-115.2 kbps	19200 bps	The port baud rate
Data format	7E, 8N, 8E	8N	Data format and parity. 7E data format should not be used with the MODBUS RTU and DNP3 protocols
Response delay	0-1000 ms	5 ms	The minimum time after the last request character is received to start the transmission.

Parameter	Options	Default	Description
Character Timeout	0-1000 ms	4 ms	The maximum time between character reception

Setting Up Ethernet

Using the Front Display

Access Communication Setup menu, Select Network 1/2 or other and setup the communication port desired parameters as described below using UP/DOWN navigation buttons and OK/ENTER button.

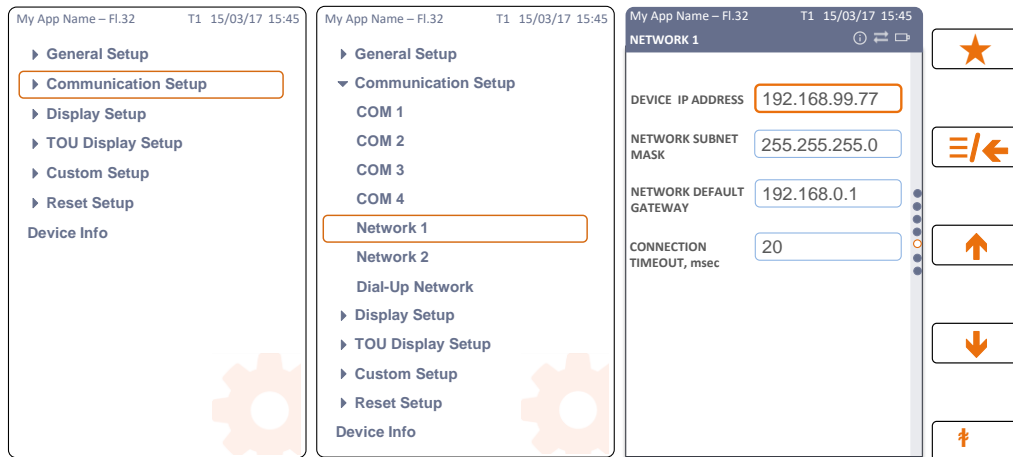

⊙ Note:

The EM235 display menus is identical to the PM335 display menus

Using PAS

Select Communications Setup from the Meter Setup menu, click on the Network Setup tab and then select Network 1 or 2.

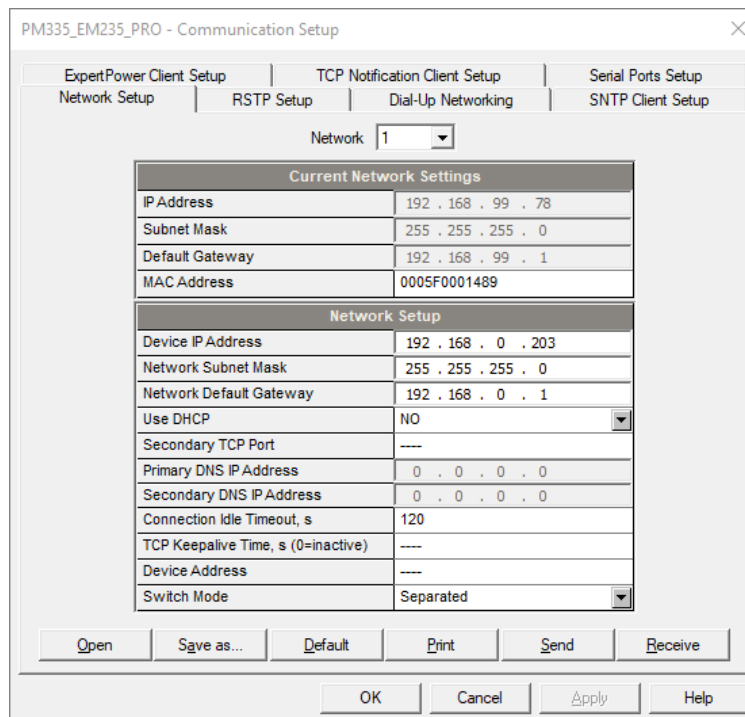

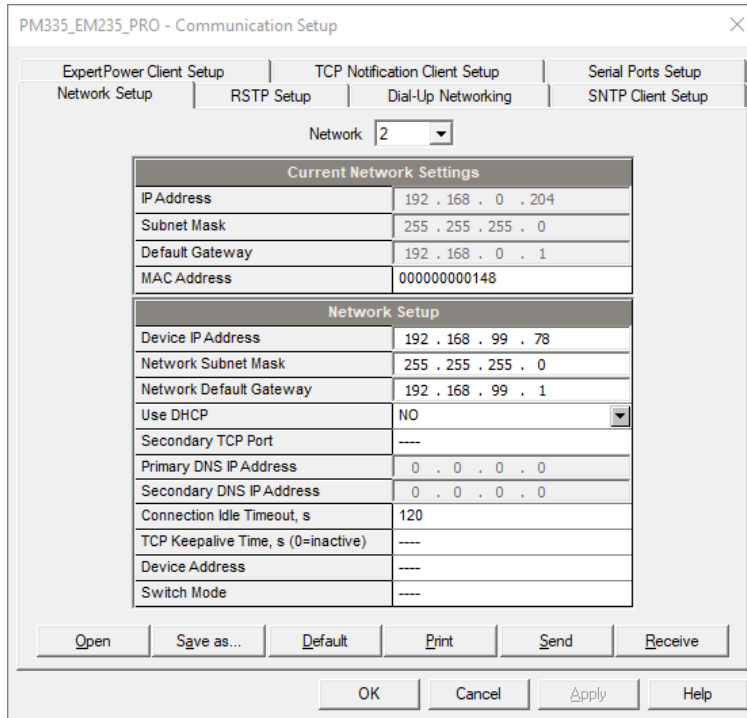

Figure 6-2: Communication Setup Dialog Box - Network 1/2 Setup Tab

The table below lists available network options.

Table 7: Ethernet Setup Options

Parameter	Options	Default
Device IP Address		192.168.0.203
Network Subnet Mask		255.255.255.0
Network Default Gateway		192.168.0.1
Use DHCP	YES/NO	NO
Switch Mode (applicable in Network 1 setup menu only)	Daisy chain/Separated	Separated

NOTES:

1. The meter provides the permanent MODBUS TCP server on port 502.
2. Selecting the DNP3 TCP service port launches the second DNP3 TCP server allowing simultaneous connections on both TCP ports. Selecting the MODBUS TCP port disables the DNP3 TCP server.
3. When you change the device network settings through the Ethernet port, the device port restarts so communication will be temporarily lost. You may need to wait some additional time until PAS restores a connection with your device.

Setting Up RSTP in Daisy Chain mode

Daisy chain may be implemented with fallback connection where a circular closed chain is connected. To enable such connection, RSTP support must be enabled within the device. This configuration is available only from the PAS.

Using PAS

Select Communications Setup from the Meter Setup menu, click on the RSTP Setup. Enable the capability by selecting YES for the RSTP Enabled field. Apply changes to all other default configuration values as required by the network administrator.

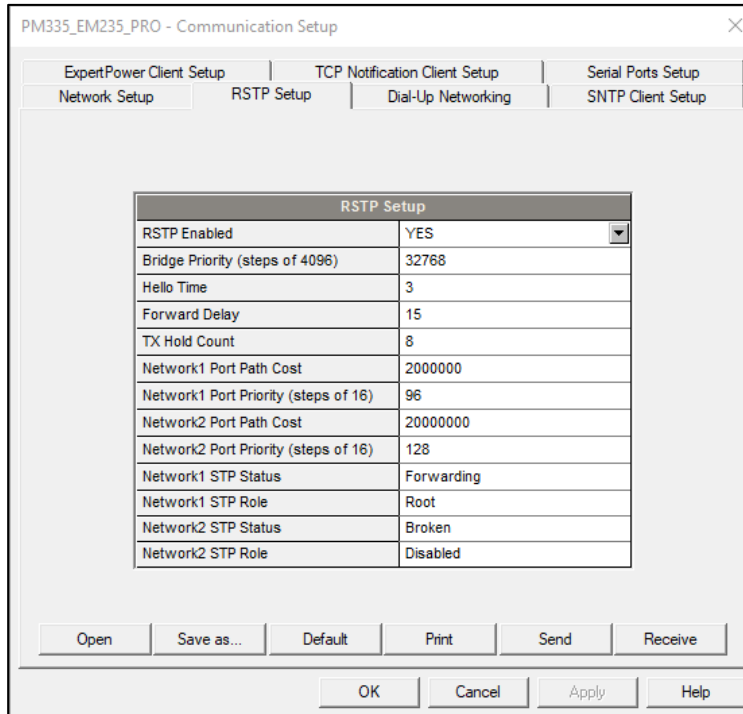

Parameter	Options	Default
Bridge Priority	4096 - 61440 in steps of 4096	32768
Hello Time	1 - 10	2
Forward Delay	4 - 30	15
TX Hold Count	1 - 10	6
Network Port Path Cost	1 - 200000000	200000
Port Priority	0 – 240 in steps of 16	128
STP Status / STP Role	Read-Only status notification	

NOTES:

- Changing the RSTP default settings may have significant impact on network health and stability. Consult with your network administrator
 - The Meter supports as default 20 chained connected devices

4.

Setting-Up SNTP Client

Select Communication Setup from the Meter Setup menu, and then click on the SNTP Client Setup tab.

The SNTP client can provide periodic synchronization of the meter clock with a publicly available SNTP server or with your local server if it supports this service.

To allow clock synchronization via SNTP, select SNTP as a clock synchronization source in [Local Settings](#).

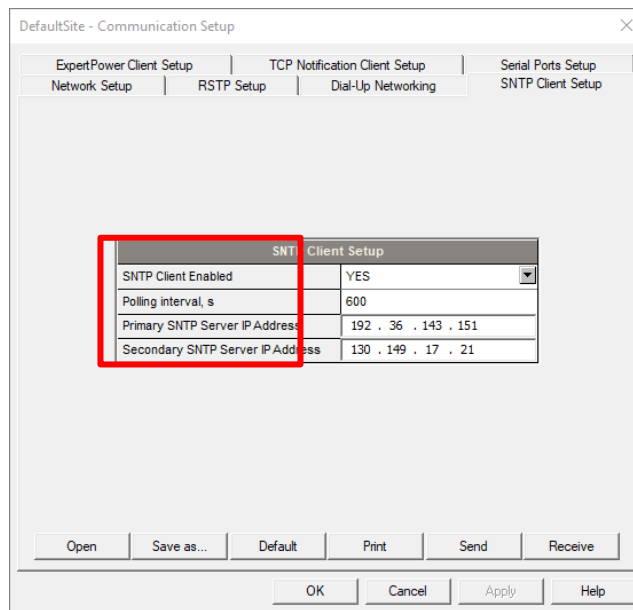

The following table lists available options

Parameter	Options	Default	Description
SNTP Client Enabled	NO, YES	NO	Enables operations of the SNTP client
Polling interval, s	60-86400 s	600 s	The time remaining requesting time from the SNTP server
Primary SNTP Server IP Address		192.36.143.151	The IP address of the primary SNTP server
Secondary SNTP Server IP Address		130.149.17.21	The IP address of a secondary SNTP server in the event of temporary unavailability of the primary server

The default SNTP server IP addresses belong to Stockholm and Berlin university servers.

SNTP can work only out of the 1st Ethernet interface. Navigate to the Communication Setup > Network Setup. Verify that Network 1 has a valid IP address and a valid Gateway (that can reach the SNTP Server).

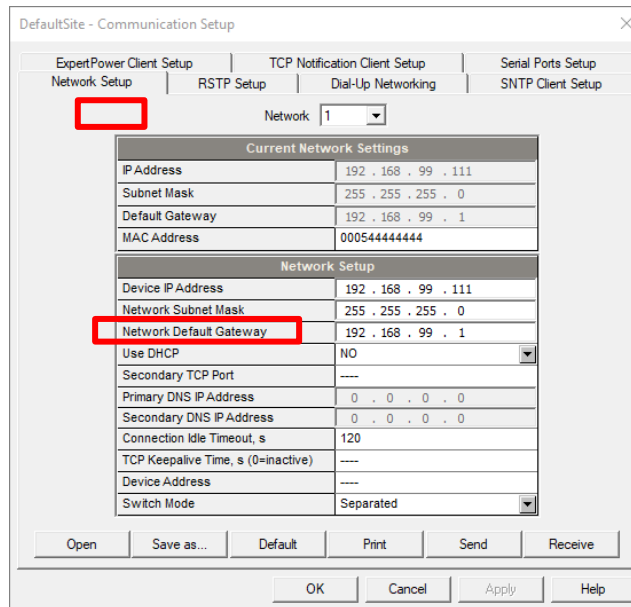

Navigate to General Setup > Local Settings. Activate the Clock synchronization and select SNTP as the method for synchronization. Make sure to set the Time Zone Offset, as the time provided by the SNTP is UTC.

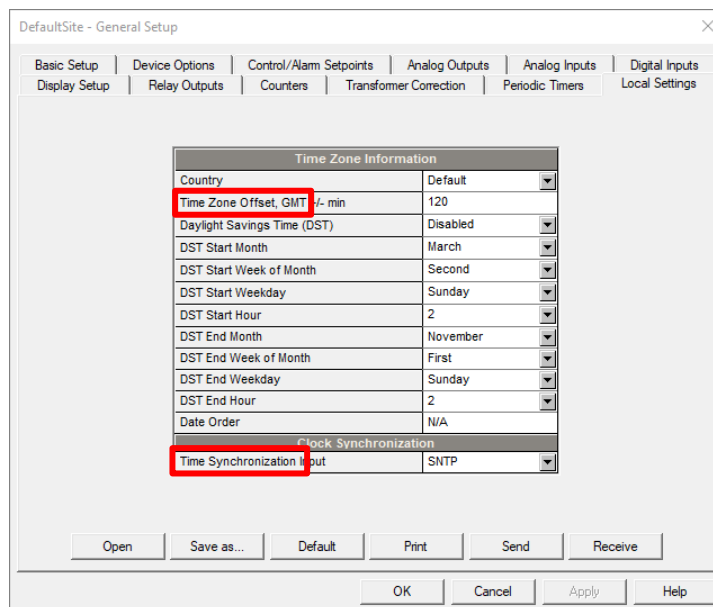

Configuring eXpertPower Client

The EM235/PM335 PRO has an embedded eXpertPower™ client that provides communications with the eXpertPower™ server – the SATEC proprietary Internet services. Connections to the eXpertPower™ server are handled on a periodic basis.

To enter the Setup dialog, select the site from the list box on the PAS toolbar, select Communication Setup from the Meter Setup menu, and then click on the ExpertPower Client Setup tab.

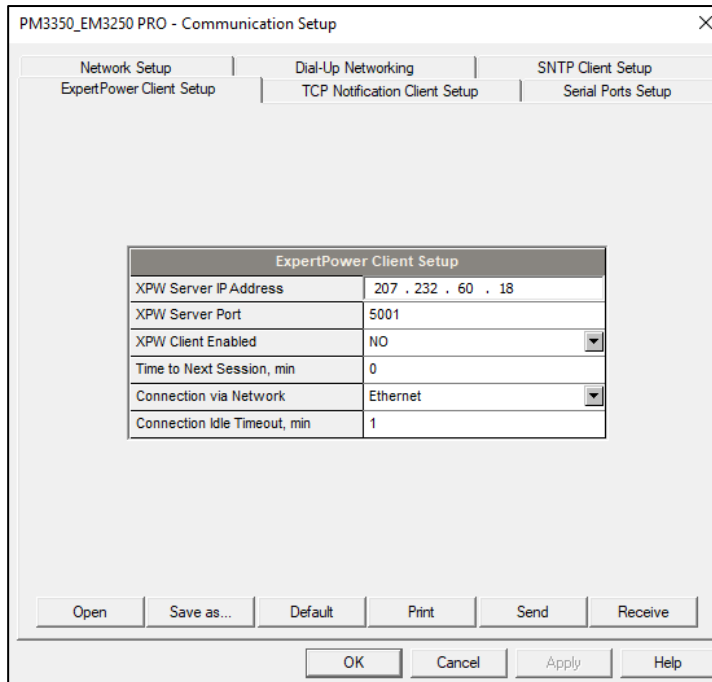

Figure 6-3: eXpertpower Client Setup Tab

The following table lists available options. Refer to your eXpertPower service provider for the correct eXpertPower settings.

Parameter	Options	Default	Description
XPW Server IP Address		207.232.60.18	The IP address of the eXpertPower server
XPW Server Port	0-65535	5001	The TCP service port of the eXpertPower server
XPW Client Enabled	NO, YES	NO	Enables operations of the eXpertPower client
Time to Next Session, min	1-99999		The time remaining to the next connection session

NOTES:

5. If you do not use the eXpertPower™ service, do not enable the eXpertPower client in your device.
6. Do not change the connection period setting. The eXpertPower server updates it automatically.

Setting Up TCP Notification Client

The TCP notification client can establish connections with a remote MODBUS/TCP server and send notification messages either on events, or periodically on a time basis.

To set up communications with a remote TCP Notification server, select Communication Setup from the Meter Setup menu, and then click on the TCP Notification Client Setup tab.

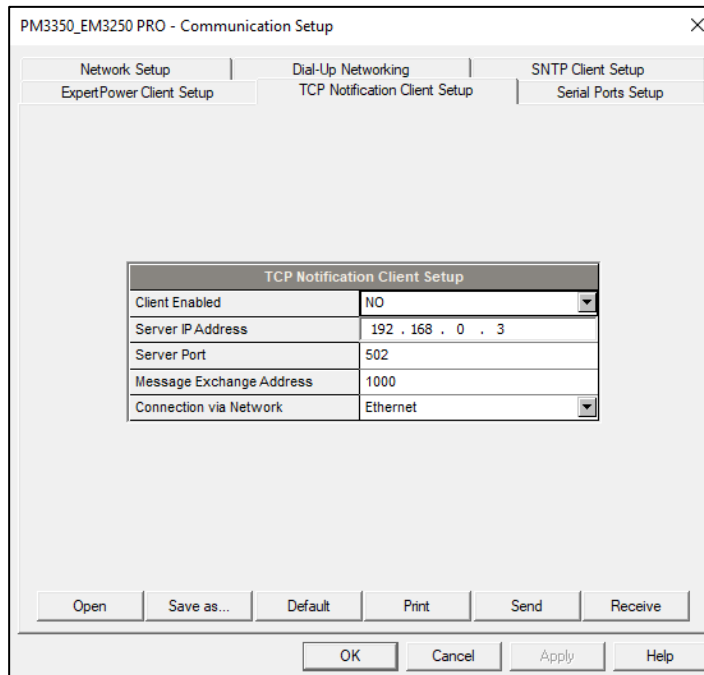

Figure 6-4: TCP Notification Client Setup Tab

The following table lists available client options.

Table 8: TCP Notification Client Setup Options

Parameter	Options	Default	Description
Client Enabled	NO, YES	NO	Enables operations of the notification client
Server IP Address		192.168.0.3	The IP address of the notification server
Server Port	0-65535	502	The TCP service port of the notification server
Message Exchange Address	0-65535	1000	The start address of a block of 16 MODBUS registers for receiving notification messages

Connections with a remote server are triggered via programmable setpoints. To send event notifications to a server, configure a setpoint to respond to desired triggers or to periodic time events and put the "Notification" action to the setpoint action list (see [Configuring Alarm/Control Setpoints](#)).

See the EM235/PM335 PRO Modbus Reference guide for more information on operation of the notification client and the notification message structure.

General Meter Setup

Basic Meter Setup

This section describes how to configure the EM235/PM335 PRO for your particular environment and application.

Before operating your meter, provide the device with basic information about your electrical network.

Using the Front Display

Access General Setup menu, Select Basic Setup and setup the device desired parameters as described below using UP/DOWN navigation buttons and OK/ENTER button.

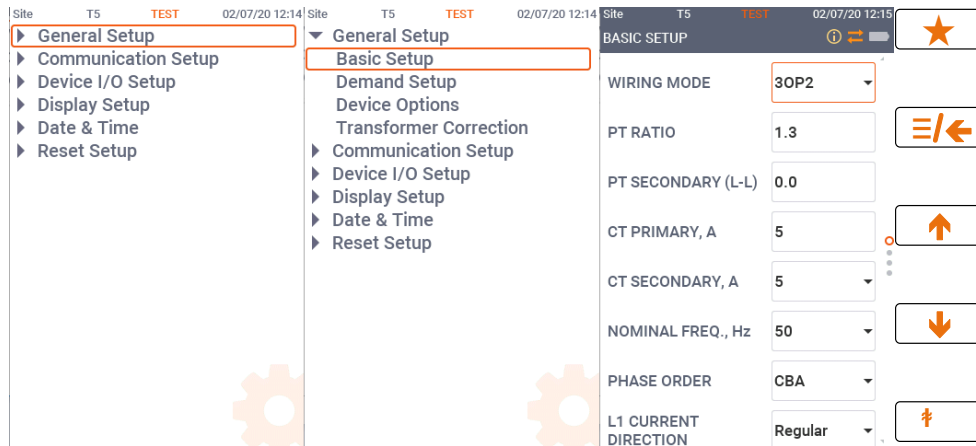

Note:

The EM235 display menus is identical to the PM335 display menus

Using PAS

Select General Setup from the Meter Setup menu. See the table below for the Basic Setup tab.

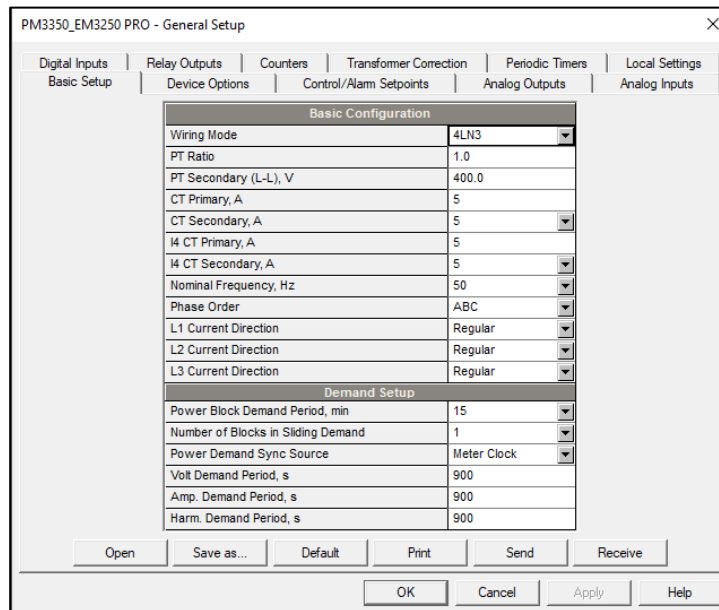

Figure 6-5: General Setup Dialog Box - Basic Setup Tab

The following table lists available client options.

Table 9: Basic Setup Options

Parameter	Options	Default	Description
Basic Configuration			
Wiring Mode	See Table 10	4Ln3	The wiring connection of the device
PT Ratio	1.0-6500.0	1.0	The phase potential transformer's primary to secondary ratio
PT Secondary (L-L), V	10-690	120	PT Ratio multiplication factor. Used in extra high voltage networks to accommodate the PT ratio for 500 kV and higher networks.
CT Primary Current	1-50000 A	5 A	The primary rating of the phase current transformer
CT Secondary Current	1A, 5 A	5 A	The secondary rating of the phase current transformer
I4 CT Primary Current	1-50000 A	5 A	The primary rating of the fourth current transformer (can be neutral current)
I4 CT Secondary Current	1A, 5 A	5 A	The secondary rating of the fourth current transformer (can be neutral current)
Nominal Frequency	50,60,400 ¹ Hz	60 Hz	The nominal line frequency
Phase order	ABC, CBA	ABC	The normal phase sequence
L1 Current Direction	Regular, reverse	Regular	Current wiring direction
L2 Current Direction	Regular, reverse	Regular	Current wiring direction
L3 Current Direction	Regular, reverse	Regular	Current wiring direction
Demand Setup			
Power Block demand period, min	1, 2, 5, 10, 15, 20, 30, 60	15	The length of the demand period for power demand calculations
Number of Blocks in sliding window	1-15	1	The number of demand periods to be averaged for sliding window demands
Power demand sync source	Meter clock, DI1-DI48 (digital inputs 1-48)	Meter clock	The source input for synchronization of the demand intervals. If a digital input is specified as the source, a pulse front denotes the start of the demand interval
Volt demand period, s	0 - 9000 sec	900	The length of the demand period for ampere demand calculations
Amp. demand period, s	0 - 9000 sec	900	The length of the demand period for volt demand calculations
Harm. demand period	0 - 9000 sec	900	The length of the demand period for harmonic demand calculations

Note:

1. Always specify the wiring mode and transformer ratings prior to setting up setpoints and analog outputs.
2. The maximum value for the product of the phase CT primary current and PT ratio is 57,500,000. If the product is greater, power readings are zeroed.

¹ Future option

Table 10 lists the available wiring modes.

Table 10: Wiring Modes

Wiring Mode	Description
3OP2	3-wire Open Delta using 2 CTs (2 element)
4LN3	4-wire Wye using 3 PTs (3 element), line-to-neutral voltage readings
3DIR2	3-wire Delta Direct Connection using 2 CTs (2 element)
4LL3	4-wire Wye using 3 PTs (3 element), line-to-line voltage readings
3OP3	3-wire Open Delta using 3 CTs (2½ element)
3LN3	4-wire Wye using 2 PTs (2½ element), line-to-neutral voltage readings
3LL3	4-wire Wye using 2 PTs (2½ element), line-to-line voltage readings
3BLN3	3-wire Broken Delta using 2 PTs, 3 CTs (2½ element), line-to-neutral voltage readings
3BLL3	3-wire Broken Delta using 2 PTs, 3 CTs (2½ element), line-to-line voltage readings

Note:

In 4LN3, 3LN3 and 3BLN3 wiring modes, the voltage readings for min/max volts and volt demands represent line-to-neutral voltages; otherwise, they will be line-to-line voltages. The voltage waveforms and harmonics in 4LN3, 3LN3 and 3BLN3 wiring modes represent line-to-neutral voltages; otherwise, they will show line-to-line voltages.

Device Options

The Device Options setup allows changing user-configurable device options or putting the meter into energy test mode.

Using the Front Display

Access General Setup menu, Select Device Options and setup the device desired parameters as described below using UP/DOWN navigation buttons and OK/ENTER button.

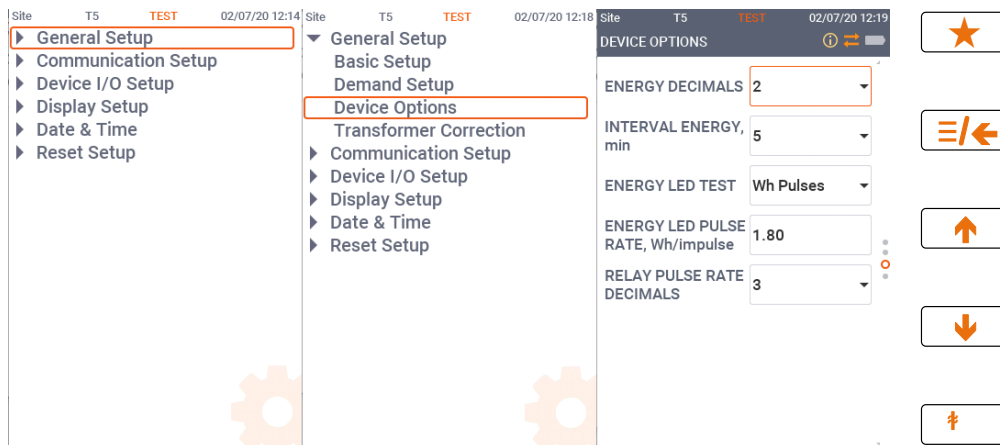

Note:

The EM235 display menus is identical to the PM335 display menus

Using PAS

Select General Setup from the Meter Setup menu, and then click on the Device Options tab.

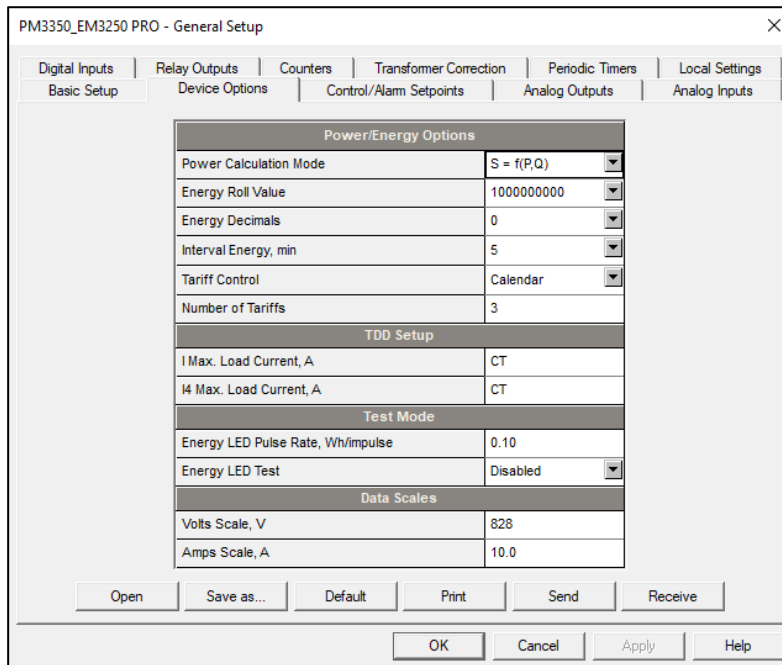

Figure 6-6: General Setup Dialog Box - Device Options Tab

Table 11 lists available device options.

Table 11: User-configurable Device Options

Parameter	Options	Default	Description
Power/Energy Options			
Power Calculation Mode	Reac = using reactive power $S=f(P, Q)$, Nact = using non-active power $Q=f(S, P)$	$S=f(P, Q)$	The method used for calculating reactive and apparent powers (see Power Calculation Modes below)
Energy Roll Value	10000 kWh 100000 kWh 1000000 kWh 10000000 kWh 100000000 kWh	10000000	The value at which energy counters roll over to zero
Energy Decimals ²	0-3	0	Number of digits after decimal point
Interval Energy, min	5, 10, 15, 20, 30	15	Recorded accumulated energy in predefined interval
Tariff Control	Calendar, Communication, DI	Calendar	Define the Tariff control
Number of Tariffs	1-8	1	Define the number of tariffs
TDD Setup			
I Max. Load Current, A	0 - 10000 A	CT	The maximum demand load current for common current inputs (0 = CT primary)

² The number of digits after decimal points is part of total of digits of Energy roll value

Parameter	Options	Default	Description
I4 Max. Load Current, A	0 - 10000 A	CT	The maximum demand load current for I4 (0 = CT primary)
Test Mode			
Energy LED Pulse Rate, Wh/Impulse	0.01-0.4	0.1	LED pulse constant - the amount of accumulated energy (in secondary readings) giving one pulse via "kWh" and "kvarh" LEDs.
Energy Test Mode	Disabled Wh pulses varh pulses	Disabled	Setting this option puts the meter into the energy test mode (see Energy Pulse LED in Chapter 3)
Data Scale			
Volts Scale, V	10-828 V	828 V	The allowed, in secondary volts. See Data Scales in Chapter 19.
Amps Scale, A	1.0-10.0 A	10	The maximum current scale allowed, in secondary amps. See Data Scales in Chapter 19.

Power Calculation Modes

The power calculation mode option allows you to change the method for calculating reactive and apparent powers in presence of high harmonics. The options work as follows:

- When the reactive power calculation mode is selected, active and reactive powers are measured directly and apparent power is calculated as:

$$S = \sqrt{P^2 + Q^2}$$

- This mode is recommended for electrical networks with low harmonic distortion, commonly with THD < 5% for volts, and THD < 10% for currents. In networks with high harmonics, the second method is preferable.
- When the non-active power calculation mode is selected, active power is measured directly, apparent power is taken as product $S = V \times I$, where V and I are the RMS volts and amps, and reactive power (called non-active power) is calculated as:

$$N = \sqrt{S^2 - P^2}$$

Transformer Correction

While using external CT meter option, transformer correction allows you to compensate ratio and phase angle inaccuracies of the user voltage and current instrument transformers.

Using the Front Display

Access General Setup menu, Select Transformer Correction and setup the device desired parameters as described below using UP/DOWN navigation buttons and OK/ENTER button.

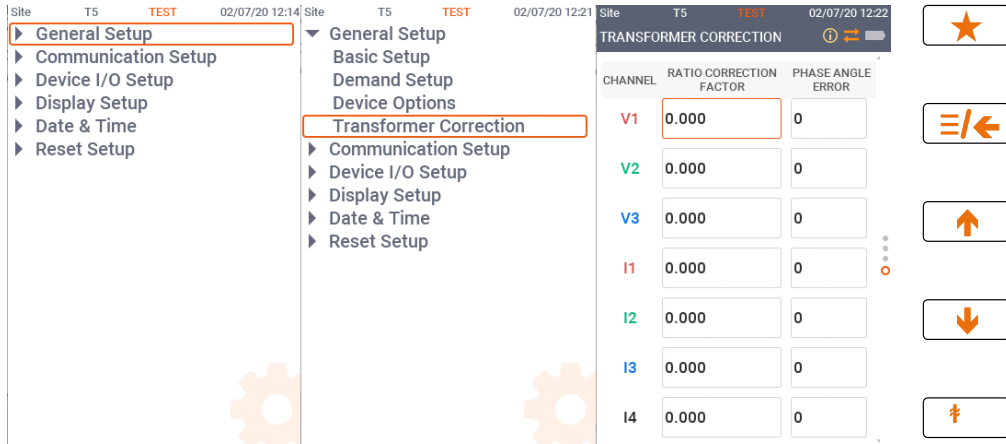

Note:

The EM235 display menus is identical to the PM335 display menus

Using PAS

Select General Setup from the Meter Setup menu, and then click on the Transformer Correction tab.

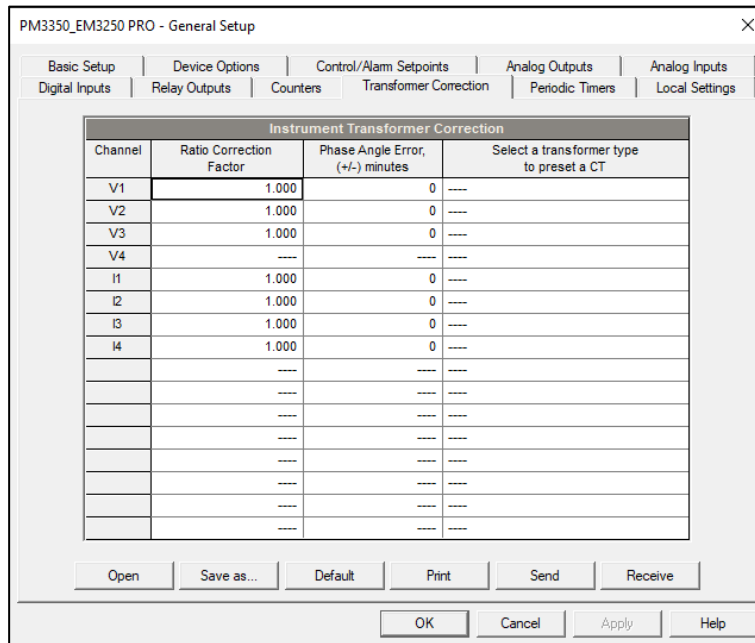

Figure 6-7: General Setup Dialog Box - Digital Inputs Dialog Box

The following table lists available options.

Label	Parameter	Options	Default	Description
Ratio V1-V3	V1-V3 voltage transformer ratio correction factor	0.700 to 1.300	1.000	The ratio of the true transformer ratio to the marked ratio.
Angle V1-V3	V1-V3 transformer phase angle error, minutes	-600 to 600	0	The phase displacement, in minutes, between the primary and secondary values. The phase angle of a voltage transformer is positive when the secondary value leads the primary value.
Ratio I1-I4	I1-I3 current transformer ratio correction factor	0.700 to 1.300	1.000	The ratio of the true transformer ratio to the marked ratio.
Angle I1-I4	I1-I3 transformer phase angle error, minutes	-600 to 600	0	The phase displacement, in minutes, between the primary and secondary values. The phase angle of a current transformer is positive when the secondary value leads the primary value.

Configuring Digital Inputs

The EM235/PM335 PRO can be provided with two to twenty six (up to 3 x 8DI module) digital inputs that can be linked to control setpoints to give an indication on input status change (see [Configuring Alarm/Control Setpoints](#)), or can be linked to general pulse counters to count incoming pulses (see [Configuring Counters](#)). They can also be linked to the Billing/TOU registers to count pulses from external wattmeters or gas and water meters.

Using the Front Display

Access General Setup menu, Select Digital Inputs and setup the device desired parameters as described below using UP/DOWN navigation buttons and OK/ENTER button.

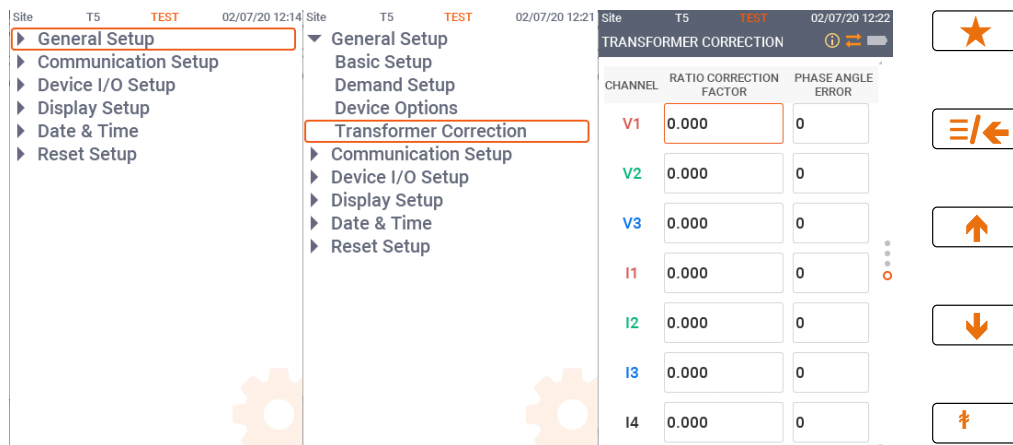

Note:

The EM235 display menus is identical to the PM335 display menus

Using PAS

Select General Setup from the Meter Setup menu, and then click on the Digital Inputs tab.

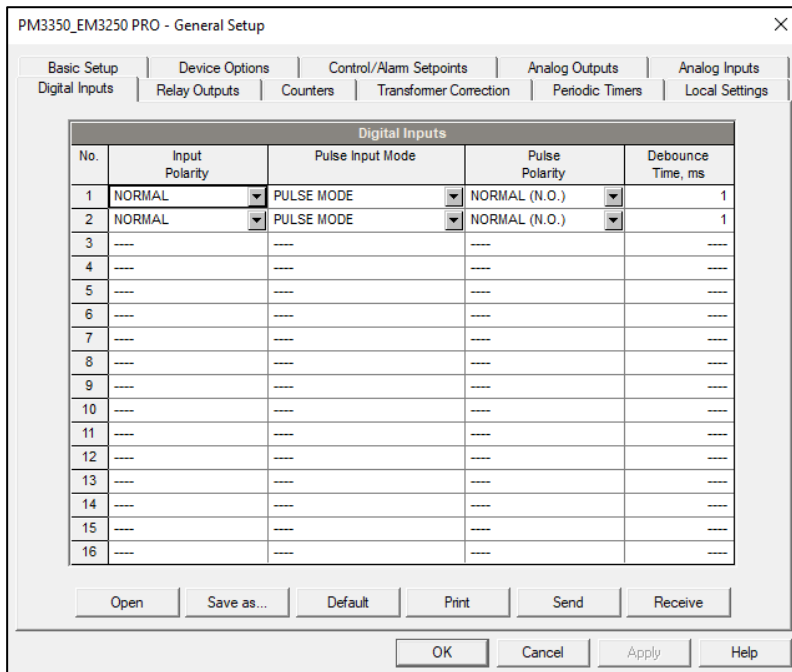

Figure 6-8: General Setup Dialog Box - Digital Inputs Dialog Box

The available options are shown in Table 12.

Table 12: Digital Input Options

Parameter	Options	Default	Description
Pulse Input Mode	PULSE MODE KYZ MODE	PULSE MODE	In pulse mode, either leading, or trailing edge of the input pulse is recognized as an event. In KYZ mode, both leading and trailing edges of the input pulse are recognized as separate events.
Pulse Polarity	NORMAL (N.O.), INVERTING (N.C.)	NORMAL	For the normal polarity, the open to closed transition is considered a pulse. For the inverting polarity, the closed to open transition is considered a pulse. It has no meaning in KYZ mode where both transitions are used.
Debounce Time	1-100 ms	10 ms	The amount of time while the state of the digital input should not change to be recognized as a new state. Too low debounce time could produce multiple events on the input change.

The debounce time is applied the same for all digital inputs. If you change the debounce time for a digital input, the same debounce time is automatically assigned to the others.

Configuring Relay Outputs

The EM235/PM335 PRO can be provided with one to seven (depend on DI/O module type) optional relay outputs. Each relay can be operated either locally from the alarm/control setpoints in response to an event or by a remote command sent through communications. It can also be linked to an internal pulse source to produce energy pulses.

Using the Front Display

Access General Setup menu, Select Relay Outputs and setup the device desired parameters as described below using UP/DOWN navigation buttons and OK/ENTER button.

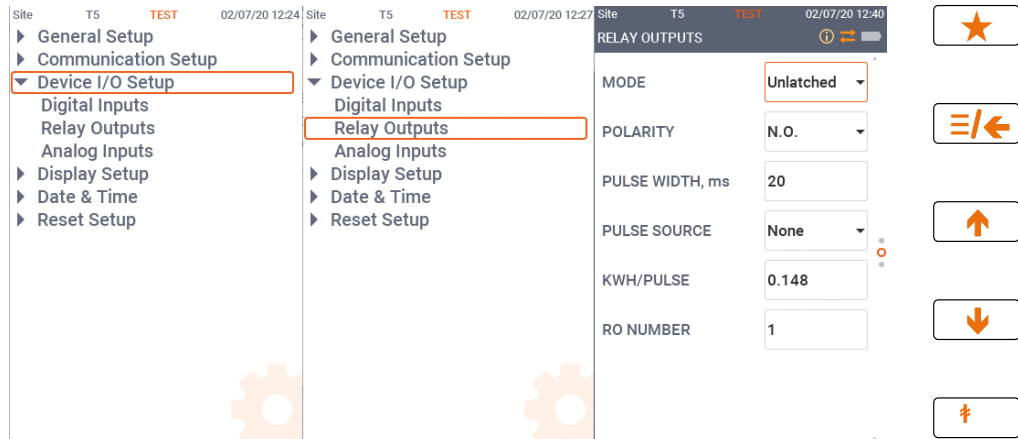

Note:

The EM235 display menus is identical to the PM335 display menus

Using PAS

Select General Setup from the Meter Setup menu, and then click on the Relay Outputs tab.

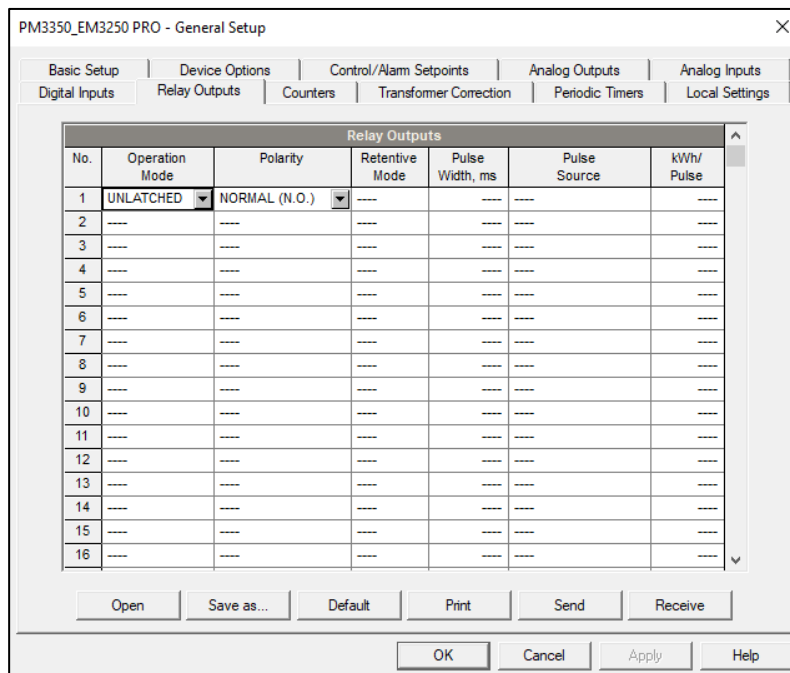

Figure 6-9: General Setup Dialog Box - Relay Outputs Tab

The available relay outputs options are shown in Table 13.

Table 13: Relay Output Options

Option	Format/Range	Default	Description
Operation Mode	Unlatched Latched Pulse KYZ	Unlatched	<p>Defines the behavior of the relay in response to local and remote commands</p> <p>Unlatched mode: the relay goes into its active state when the control setpoints is in active (operated) state, and returns into its non-active state when the setpoints is released.</p> <p>Latched mode: the relay goes into its active state when the control setpoints goes into active state and remains in the active state until it is returned into its non-active state by another setpoints or by a remote command.</p> <p>Pulse mode: the relay goes into its active state for the specified time, goes into non-active state for the specified time and remains in the non-active state.</p> <p>KYZ mode: the relay generates transition pulses. The relay changes its output state upon each command and remains in this state until the next command.</p>
Polarity	NORMAL (N.O.) Inverting (N.C.)	Normal	<p>Defines whether the relay is energized or de-energized in its non-active and active (operated) states.</p> <p>With normal polarity, the relay is normally de-energized in its non-active state and is energized in its active (operated) state.</p> <p>With inverting polarity, the relay is normally energized in its non-active state and is de-energized in its active (operated) state. It is called sometimes failsafe relay operation.</p>
Retentive mode	Checked Unchecked	Unchecked	<p>This option is only applicable for latched relays. Normally, when retentive mode is OFF, the relay is always returned into its non-active state upon power up.</p> <p>If the relay is set to be retained, the device restores its status to what it was prior to loss of power.</p>
Pulse width	10-1000 ms	100 ms	<p>The amount of time the pulse relay stays in active state when generating a pulse. The actual pulse width is a multiple of the 1/2-cycle time rounded to the nearest bigger value.</p> <p>The minimum pause time between pulses is equal to the pulse width.</p>
Pulse source	None kWh IMP PULSE kWh EXP PULSE kWh TOT PULSE kvarh IMP PULSE kvarh EXP PULSE kvarh TOT PULSE kVAh TOT PULSE	---	Links the pulse relay to the internal pulse event that is to be retransmitted through the relay output as a pulse with a predefined width. The relay must be set into either pulse, or KYZ mode.
kWh/Pulse	0.001-1000	1	Defines the pulse weight in kWh units per pulse.

Generating Energy Pulses through Relay Outputs

To generate energy pulses through a relay output:

1. Set a relay to either pulse, or KYZ mode, and then select a polarity (active pulse edge) for energy pulses and a pulse width.
2. Select a source energy accumulator and the pulse rate for your output.
3. Send your new setup to the meter.

Configuring Analog Inputs

The meter is equipped with one on-board analog input sensing from -0.1mA to 20mA and can be configured to 0-1mA, ±1mA, 0-20mA and 4-20mA current inputs.

The meter can also be ordered with three optional analog inputs modules (future) with options for 0-1mA, ±1mA, 0-20mA and 4-20mA current inputs.

The meter automatically converts the AI readings received from the analog-to-digital converter to the user-defined engineering scale and shows the input values in true engineering units, for example, in volts, amps, or degrees, with the desired resolution.

Using PAS

Select General Setup from the Meter Setup menu, and then click on the Analog Inputs tab.

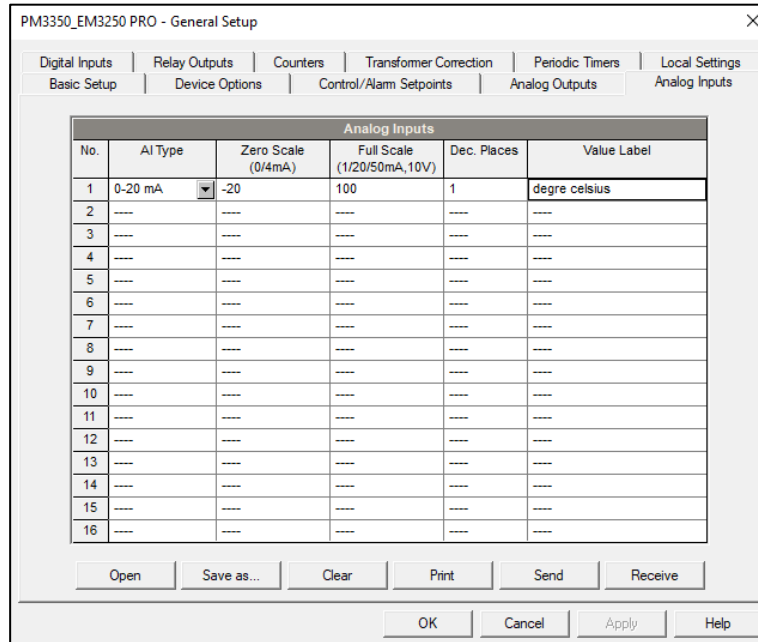

Figure 6-10: General Setup Dialog Box - Analog Inputs Tab

The available AI options are listed in the following table:

Table 14: Analog Inputs options

Option	Range	Description
AI type	0-1 mA ±1 mA 0-20 mA 4-20 mA	The AI module type. When connected to the device, shows the actual AI type read from the AI module.
Zero scale	0/4 mA	Defines the low engineering scale (in primary units) for the analog input corresponding to a lowest (zero) input current (0 or 4 mA, or 0 V)
Full scale	1/20	Defines the high engineering scale (in primary units) for the analog input corresponding to a highest input current (1, 20)
Dec. Places		The number of decimal digits in a fractional part of the scaled engineering value
Value label		An arbitrary name you can give the analog input value

NOTE:

Always save your AI setup to the site database in order to keep the labels you gives the analog inputs. They are not stored in your device.

Configuring Analog Outputs (future)

The meter can be ordered with three optional analog outputs with options for 0-1mA, ±1mA, 0-20mA and 4-20mA current outputs.

Using PAS

Select General Setup from the Meter Setup menu, and then click on the Analog Outputs tab.

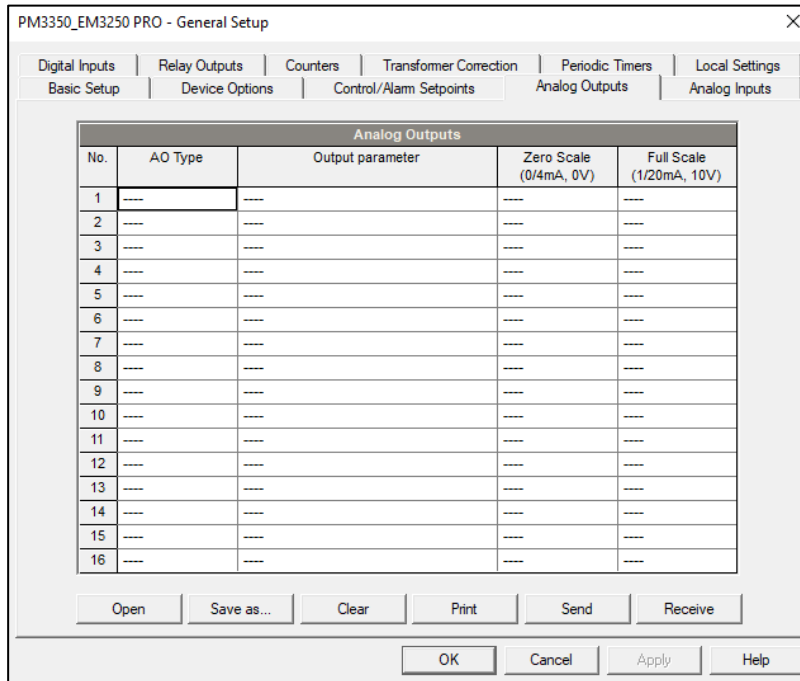

Figure 6-11: General Setup Dialog Box - Analog Outputs Tab

The available analog output options are described in Table 15.

Table 15: Analog Output Options

Option	Range	Description
AO type	0-1mA ±1mA 0-20mA 4-20mA	The analog output type. When connected to the meter, shows the actual AO type received from the device. When working off-line, select the analog output option corresponding to your analog module.
Output parameter	See Chapter 15	Selects the measured parameter to be transmitted through the analog output channel.
Zero scale		Defines the low engineering scale (in primary units) for the analog output corresponding to a lowest (zero) output current (0 or 4 mA)
Full scale		Defines the high engineering scale (in primary units) for the analog output corresponding to a highest output current (1 or 20 mA)

When you select an output parameter for the analog output channel, the default engineering scales are set automatically. They correspond to the maximum available scales. If the parameter actually covers a lower range, you can change the scales to provide a better resolution on an analog output.

Scaling Non-Directional Analog Outputs

For non-directional analog outputs with a 0-1mA, 0-20mA or 4-20mA current option, you can change both zero and full engineering scales for any parameter. The engineering scale need not be symmetrical.

Scaling Directional Power Factor

The engineering scale for the signed power factor emulates analog power factor meters.

The power factor scale is -0 to +0 and is symmetrical with regard to ±1.000 (-1.000 ≡ +1.000). The negative power factor is scaled as -1.000 minus the measured value, and non-negative power factor is

scaled as +1.000 minus the measured value. To define the entire power factor range from -0 to +0, the default scales are specified as -0.000 to 0.000.

Scaling ± 1 mA Analog Outputs

Programming engineering scales for directional ± 1 mA analog outputs depends on whether the output parameter represents unsigned (as volts and amps) or signed (as powers and power factor) values.

For an unsigned output value, you can change both zero and full engineering scales.

For a signed (directional) value, you should only provide the engineering scale for the +1 mA output current.

The engineering scale for the 0 mA output current is always equal to zero for all values except the signed power factor, for which it is set to 1.000 (see [Scaling Directional Power Factor](#) above).

The meter does not allow access to the low scale setting if the parameter is directional. Whenever the sign of the output parameter is changed to negative, the meter automatically uses the full engineering scale setting for +1 mA with a negative sign.

Scaling Analog Outputs for 0-2 mA and ± 2 mA

The 0-1 mA and ± 1 mA current outputs provide a 100% overload, and actually output currents up to 2 mA and ± 2 mA whenever the output value exceeds the engineering scale you set for the 1 mA or ± 1 mA.

The output scales for 0-1 mA and ± 1 mA analog outputs are programmed for 0 mA and +1 mA regardless of the required output current range.

To use the entire output range of 2 mA or ± 2 mA, set the analog output scales as follows:

- 0-2 mA: set the 1 mA scale to $\frac{1}{2}$ of the required full scale output for uni-directional parameters, and set the 0 mA scale to the negative full scale and the 1 mA scale to zero for bi-directional parameters.
- ± 2 mA: set the 1 mA scale to $\frac{1}{2}$ of the required full-scale output for both uni-directional and bi-directional parameters.

For example, to provide the 0 to 2 mA output current range for Volts measured by the meter in the range of 0 to 120V, set the 1 mA scale to 60V; then the 120V reading will be scaled to 2 mA.

Using Counters

The EM235/PM335 PRO has 32 nine-digit signed counters that count different events. Each counter is independently linked to any digital input and count input pulses with a programmable scale factor. You can link a number of digital inputs to the same counter. Each counter can be incremented or decremented through the Control Setpoints in response to any internal or external event.

Using PAS

Select General Setup from the Meter Setup menu, and then click on the Counters tab.

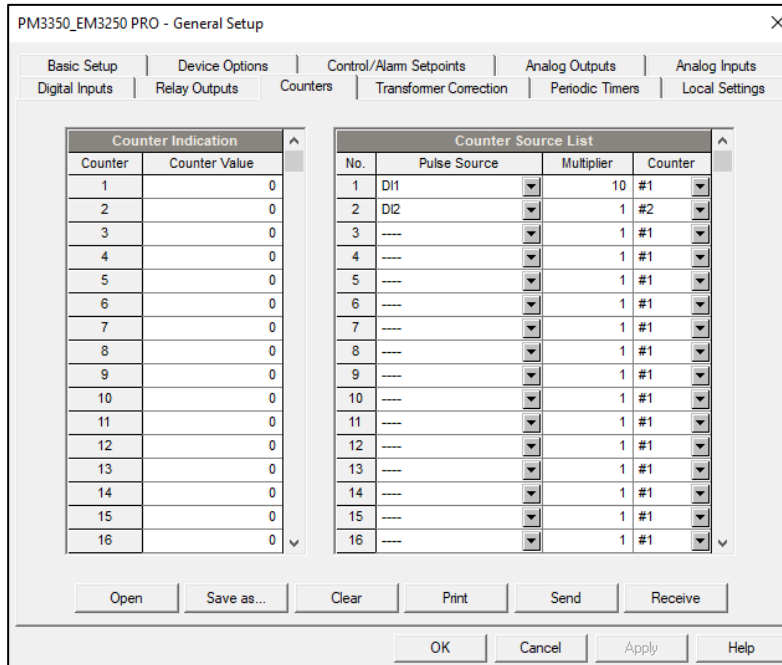

Figure 6-12: General Setup Dialog Box - Pulse/Event Counters

Table 16 lists available counter options.

Table 16: Counter Options

Option	Range	Default	Description
Pulse Input	None, DIGITAL INPUT #1 - #26	None	Links a digital input to the counter
Multiplier	1-10000	1	The value added to the counter when a pulse is detected on the pulse source input
Counter Value			Displays the present counter contents

You can preset a counter to a required value or clear it without affecting the counter setup.

To preset or clear a counter:

1. Click the Online button on the PAS toolbar before accessing the setup dialog box.
2. Type in the required value into the Counter Value field.
3. Click Send

Using Periodic Timers

The EM235/PM335 PRO has 16 programmable timers that are used for periodic recording and triggering operations on a time basis through the Control Setpoints. When a pre-programmed timer interval is expired, the timer generates an internal event that can trigger any setpoints (see [Using Control Setpoints](#)). The programmable time interval can be from 1/2 cycle and up to 24 hours.

To configure the device timers, select General Setup from the Meter Setup menu, and then click on the Periodic Timers tab.

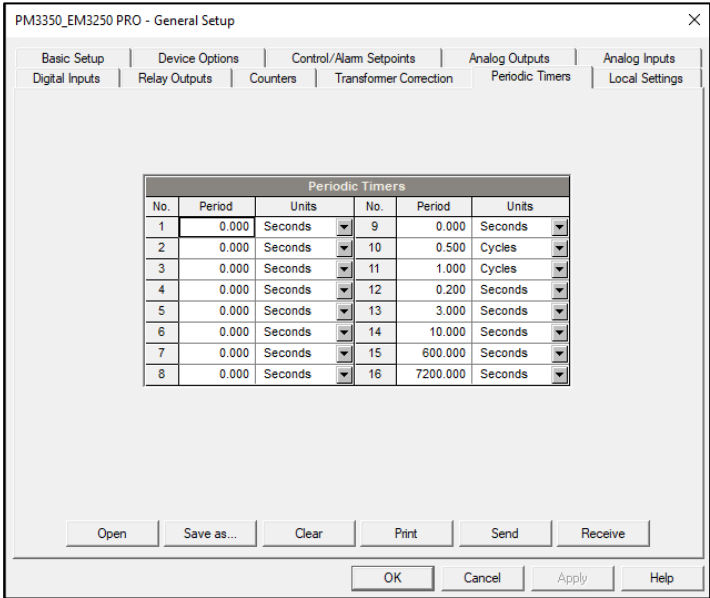

Figure 6-13: General Setup Dialog Box - Periodic Timers

Table 16 lists available counter options.

Table 17: Periodic Timers options

Option	Range	Default	Description
Period	0 = disabled 0.010 - 100,000.000 sec 0.500 - 100,000.000 cycles	0	The timer period
Units	Seconds, Cycles	Seconds	The time units

Seven timers from Timer #10 through Timer #16 are factory preset and cannot be re-programmed. They are primarily intended for the use with the Power Quality and Fault recorders. Other timers can be programmed by the user.

To run a periodic timer, select the desired time unit and specify a non-zero time period.

To stop a timer, set the time period to zero.

Using Control Setpoints

The EM235/PM335 PRO has an embedded logical controller that runs different actions in response to user-defined internal and external events. Unlike a PLC, the EM235/PM335 PRO uses a simplified programming technique based on setpoints that allows the user to define a logical expression based on measured analog and digital values that produces a required action.

The EM235/PM335 PRO provides 64 control setpoints with programmable operate and release delays. Each setpoints evaluates a logical expression with up to four arguments using OR/AND logic. Whenever an expression is evaluated as “true”, the setpoints performs up to four concurrent actions that can send a command to the output relays, increment or decrement a counter, or trigger a recorder.

To program the setpoints, select General Setup from the Meter Setup menu, and then click on the Control/Alarm Setpoints tab.

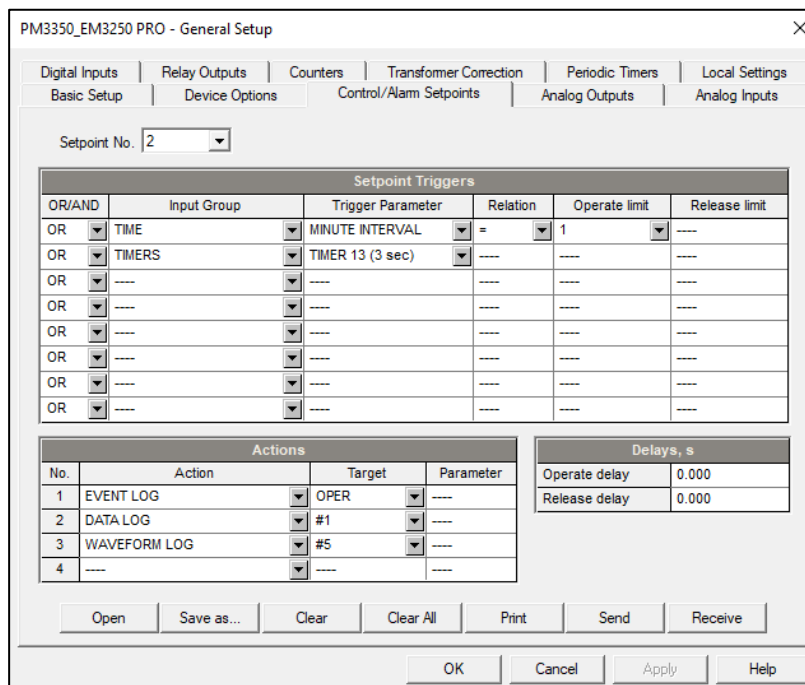

Figure 6-14: General Setup Dialog Box - Control/Alarm Setpoints

The available setpoints options are described in the following table:

Table 18: Control/Alarms Setpoints options

Option	Format/Range	Description
Setpoints Triggers		
OR/AND	OR, AND	The logical operator for the trigger
Input group		The trigger parameter group (see Chapter 7)
Trigger parameter		The trigger parameter that is used as an argument in the logical expression (see Chapter 7)
Relation	<=, >=, =, <>, Delta, Delta+, Delta-, rDelta, rDelta+, rDelta-	The relational operator used in the conditional expression for the trigger
Operate limit		The threshold (in primary units) at which the conditional expression would be evaluated to true. Not applicable for digital triggers.
Release limit		The threshold (in primary units) at which the conditional expression would be evaluated to false. Defines the hysteresis for analog triggers. Not applicable for digital triggers.
Setpoints Actions		
Action		The action performed when the setpoints expression is evaluated to true (see Chapter 6)
Target		The optional action target
Parameter		The optional action argument (reserved)
Delays		
Operate delay	0-10,000.000 sec	The time delay before operation when the operate conditions are fulfilled
Release delay	0-10,000.000 sec	The time delay before release when the release conditions are fulfilled

The logical controller provides very fast response to events. The scan time for all setpoints is 1/2 cycle time (8 ms at 60Hz and 10 ms at 50 Hz).

Setpoints #1 is factory preset to provide standard periodic data logs on a 15-minute time basis. It is linked to the device clock and runs Data logs #1 and #2 at 15-minute boundaries of an hour.

Using Logical Expressions

Logical operators OR/AND are treated in a simplified manner. They have no specific priority or precedence rules.

Any trigger condition bound to the logical expression by the OR operator and evaluated as “true” overrides any preceding condition evaluated as “false”. Similarly, any trigger condition evaluated as “false” and bound by the AND operator overrides any condition evaluated before it as “true”.

To avoid confusion, it is recommended not to alternate different logical operators in one expression. Instead, bring all conditions that use the same logical operator together at one side of the expression, and the others - at the opposite side.

To explicitly override all other conditions with the critical trigger, put it at the end of the expression using the OR operator if you want the setpoints to be operated anyway when the trigger condition is asserted, and with the AND operator, if the setpoints should not be operated while the critical trigger is not asserted.

Using Numeric Triggers

For numeric (analog) triggers, a setpoints allows you to specify two thresholds for each trigger to provide hysteresis (dead band) for setpoints operations. The Operate Limit defines the operating threshold, and the second Release Limit defines the release threshold for the trigger. The trigger thresholds are always specified in primary units.

If you use relational operators as “<=” (under or equal) or “>=” (over or equal), always specify a correct Release Limit for the trigger. If you do not want to use hysteresis, set the Release Limit to the same as the Operate Limit.

With the “Delta” operator, the setpoints is operated when the absolute value of the difference between the last reported value and the current value exceeds the specified threshold

Using Binary Triggers

Binary (digital) triggers, as digital inputs, relays, or internal static and pulsed events, are tested for ON (closed/set) or OFF (open/cleared) status. Min/Max log parameters can be tested for a NEW event that is asserted when a new minimum or maximum value is recorded for the parameter since the last time it was checked.

The binary events are divided into two types: static events and pulsed events. Static events are level-sensitive events. A static event is asserted all the time while the corresponding condition exists. Examples are digital inputs, relays and internal static events generated by the device diagnostics, metering procedures, and Power Quality and Fault recorders.

Pulsed events are edge-sensitive events with auto-reset. A pulsed event is generated for a trigger only once when a positive transition edge is detected on the trigger input. The examples of pulsed events are pulse inputs (transition pulses on the digital inputs), internal pulsed events (energy pulses and time interval pulses), and events generated by the interval timers. The logical controller automatically clears pulsed events at the end of each scan, so that triggers that used pulsed events are prevented from being triggered by the same event once again.

Using Event Flags and Virtual Relays

The PM335 PRO has 16 common binary flags, called event flags, which can be individually set, cleared and tested through setpoints or remotely.

Event flags can be used in different applications, for example, to transfer events between setpoints in order to expand a logical expression or a list of actions that have to be done for a specific event, or to remotely trigger setpoints actions from the SCADA system or from a PLC.

In the same way, any of the 32 device relays that is not actually present in your device (it is called a virtual relay) can be used to transfer events from one setpoints to others, or to indicate events to the setpoints from the external system.

Using Interval Timers

The PM335 PRO has 16 interval timers that are commonly used for periodic recording of interval data at the time of the fault or in the presence of other events detected by setpoints. Some of the timers are factory preset for use with the Power Quality and Fault recorders, and others can be programmed to generate periodic events at user-defined intervals (see [Using Periodic Timers](#)).

Interval timers are not synchronized with the clock. When you run a timer, it generates a pulsed timer event that can trigger a setpoints if you have put the timer into a list of the setpoints triggers. When the setpoints event is asserted, the timer is restarted, and then generates the next timer event when the timer interval expires.

If you want to record interval data at predefined intervals without linking to other events, just select a timer as a setpoints trigger and specify in the setpoints actions list a data log file you want to use for recording. If you want the periodic data to be recorded in presence of a specific event, select triggers that identify your event, and then add the timer at the end of the trigger list using the AND operator.

Using Time Triggers

If you want the setpoints actions to be synchronized with the clock, for example, to provide synchronous recording interval data each 15 minutes or each hour, or to output time pulses through relay contacts, use the time triggers that generate static events synchronized to the device clock.

You can exercise the default setting for Setpoints #1 in your device as an example of using time triggers. The setpoints is pre-programmed for data profiling at 15-minute intervals using data logs #1 and #2.

Using the Voltage Disturbance Trigger

The voltage disturbance trigger (found under the VOLT DISTURB name in the SPECIAL INPUTS trigger group) detects all types of the voltage waveshape faults on any phase caused by fast transient voltages.

You can use it to record disturbances if you want to do this differently from the way the Power Quality recorder does it.

The operate threshold for the voltage disturbance trigger defines the maximum allowable voltage deviation from a steady-state level above which the device declares a waveshape fault. It is specified as a percent of the nominal voltage. Using PAS you may select volts units or % of nominal voltage from the "Preferences" tab in the "Tools/Options dialog (see [Voltage Disturbance Units](#) in Chapter 13).

The trigger does not respond to slow voltage variations whenever the voltage rise above or drop below the specified threshold takes longer than 1 cycle time.

Delaying Setpoints Operations

Two optional delays can be added to each setpoints to extend monitoring setpoints triggers for a longer time before making a decision on whether the expected event occurred or not. When a delay is specified, the logical controller changes the setpoints status only if all conditions are asserted for a period at least as long as the delay time.

Although a delay can be specified with a 1-ms resolution, the actual value is aligned at a lower 1/2-cycle time boundary.

Note that you cannot use delays with pulsed events since they are cleared immediately and do not longer exist on the next setpoints scan.

Using Setpoints Events and Actions

When a setpoints status changes, i.e., a setpoints event is either asserted or de-asserted, the following happens in your device:

The new setpoints status is logged to the setpoints status register that can be monitored from the SCADA system or from a programmable controller in order to give an indication on the expected event.

The operated setpoints status is latched to the setpoints alarm latch register, which is remotely accessible. The register holds the last setpoints alarm status until it is explicitly cleared.

Up to four programmable actions can be performed in sequence on setpoints status transition when a setpoints event is asserted.

Generally, setpoints actions are performed independently for each setpoints and can be repeated a number of times for the same target. The exceptions are relay operations, data logging and waveform logging that are shared between all setpoints using an OR scheme for each separate target.

A relay output is operated when one of the setpoints linked to the relay is activated and stays in the operated state until all of these setpoints are released (except for latched relays that require a separate release command to be deactivated).

Data logging and waveform logging directed to the same file are done once for the first setpoints among those that specify the same action, guaranteeing that there will not be repeated records related to the same time.

Recording Setpoints Events

Time-tagged setpoints events can be recorded both to the Event log, and to the Sequence-of-Events log files if you put corresponding actions into the setpoints action list.

If you link a setpoints to the Sequence-of-Events recorder, all setpoints transition events are recorded to the Sequence-of-Events log by default. If you select to record setpoints operations into the Event log, define in the action target box which transition events you want to be recorded: when the setpoints is operated, when it is released, or both events. The Event recorder puts into a log file a separate record for each active trigger caused a setpoints status transition, and a separate record for each action done on the setpoints activation (except for logging actions that are not recorded to the Event log).

If you run a number of recorders from the same setpoints action list, it is recommended that you put the Event log action before others in order to allow other recorders to use the event sequence number given to the event by the Event recorder.

Cross Triggering Setpoints

When a setpoints is operated, the device sends a broadcast UDP message across the network using one of the sixteen triggering channels. All devices that have a setpoints programmed to respond to this trigger act in response. The cross triggering delay is normally less than one cycle time.

To send a cross triggering message, put an "EXT TRIGGER" action into the setpoints actions list and select one of the sixteen triggering channels as a target. In all devices, which you want to respond to this message, select an "EXT TRIGGER" group in the setpoints triggers list and specify the channel through which the device would receive messages.

Display Setup

Custom Name ID

This allows the user to define a general purpose name to the device to be displayed at the display status bar.

Access Display Setup menu, Select Custom Name ID and setup the device custom name identification as described below using UP/DOWN navigation buttons and OK/ENTER button.

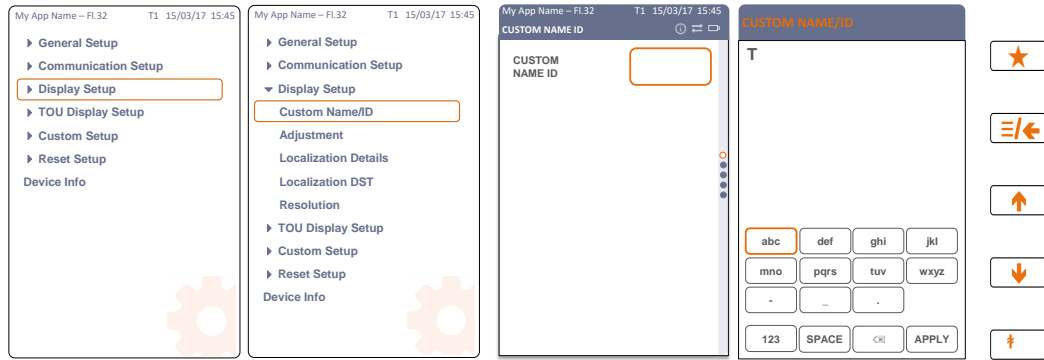

ⓘ Note:

The EM235 display menu is identical to the PM335 display menu

Adjusting the display

This display setup menu allows the user to setup the display brightness and backlight time operation. Access Display Setup menu, Select Adjustment and setup the device brightness and/or backlight time operation as described below using UP/DOWN navigation buttons and OK/ENTER button.

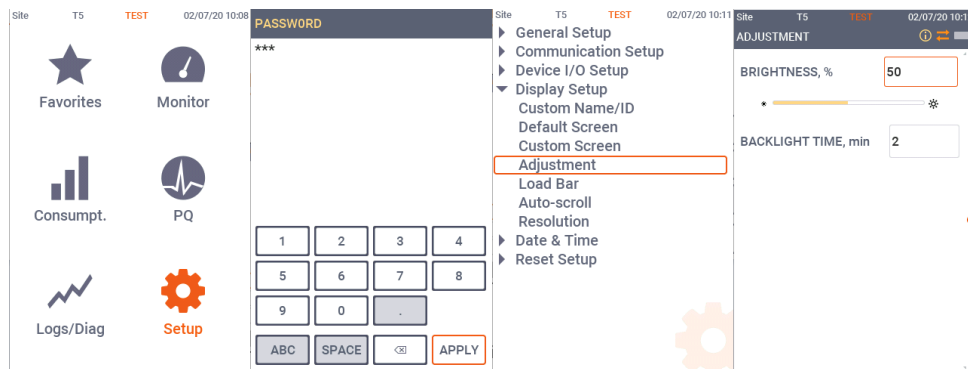

ⓘ Note:

The EM235 display menu is identical to the PM335 display menu

Updating the meter Clock

This display setup menu allows the user to setup the localization details.

Using the Front Display

Access Display Setup menu, Select Localization Details and setup the device display language, date, time, country and/or enable DST as described below using UP/DOWN navigation buttons and OK/ENTER button.

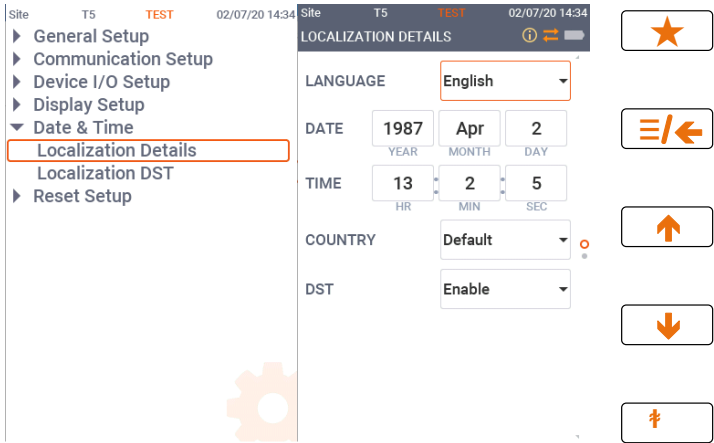

Note:
The EM235 display menus is identical to the PM335 display menus

Using PAS

Ensure that the On-line button on the PAS toolbar is checked, and then select RTC from the Monitor menu or click on the PAS toolbar Real-Time Clock Button.

The RTC dialog box displays the current PC date and time and the time in your meter.

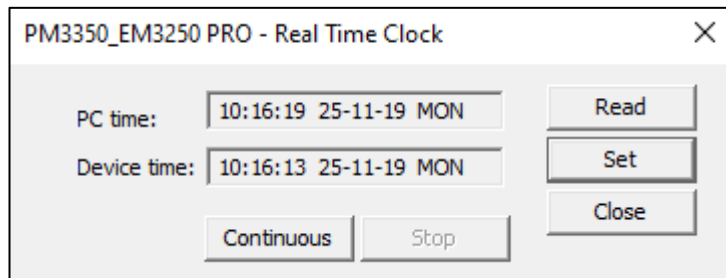

Figure 6-15: Real Time Clock Dialog Box - Time and Date setup

To synchronize the meter clock with the PC clock, click Set.

Local Time Settings

This setup allows you to select the external time synchronization source and daylight savings time options.

Daylight Savings Time

The daylight savings time option is disabled in the PM335 PRO by default, and the default daylight savings time change points are set for the U.S.A. When the daylight savings time is enabled, the PM335 PRO automatically adjusts the device clock at 02.00 AM when daylight savings time begins/ends.

If the daylight savings time option is disabled, you need to manually adjust the device clock for daylight savings time. This setup allows you to specify your time zone, daylight saving time, and clock synchronization options.

Using the Front Display

Access Display Setup menu, Select Localization DST and setup the device display DST parameters as described below using UP/DOWN navigation buttons and OK/ENTER button.

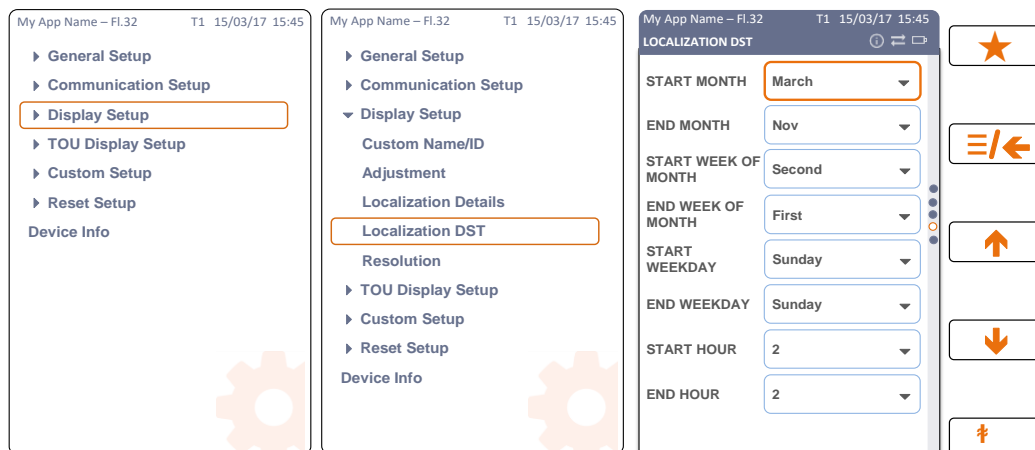

Note:

The EM235 display menus is identical to the PM335 display menus

Using PAS

To configure the local time options in your device, select the device site from the list box on the PAS toolbar, select General Setup from the Meter Setup menu, and then click on the Local Settings tab.

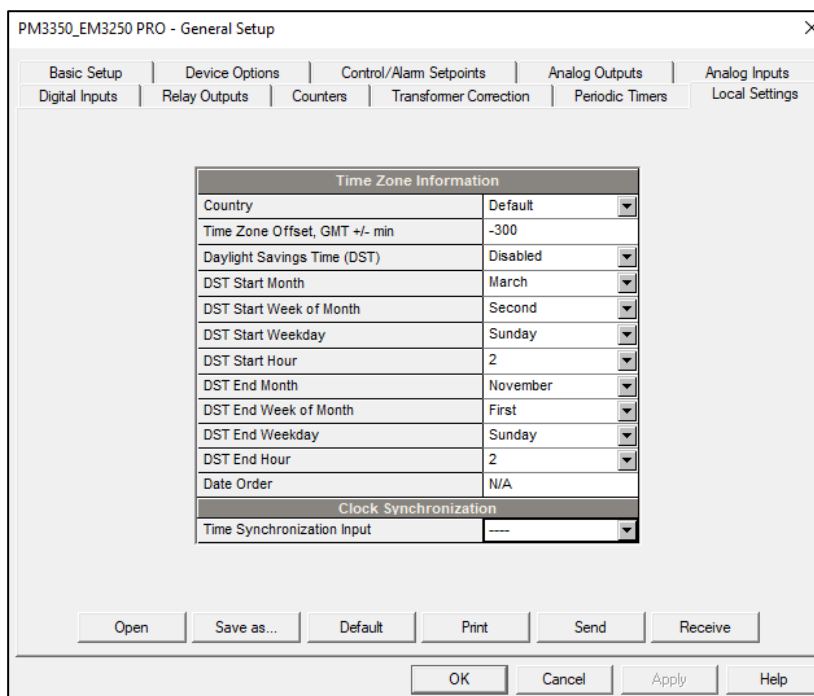

Figure 6-16: Real Time Clock Dialog Box – Time and Date setup

The available options are described in the following table:

Table 19: Time Zone setup options

Option	Format/Range	Default	Description
Time Zone Information			
Time zone offset, GMT +/- min	-720 to 720 min	-300 (Eastern Time)	Local offset in minutes from UTC (Universal Coordinated or Greenwich Mean Time). It is used to produce a local time from the GPS IRIG-B time code.
Daylight Savings Time (DST)	Disabled Enabled	Disabled	When DST is disabled, the RTC operates in standard time only. When enabled, the device automatically updates the time at 2:00 AM at the pre-defined DST switch dates.
DST start month DST start week DST start weekday DST Start Hour	Month-week-weekday-hour Month = Jan-Dec Week = 1 st , 2 nd , 3 rd , 4 th or Last (last week of the month) Day = Mon-Sun Hour = 1-6	March Second Sunday 2	The DST start date when Daylight Savings Time begins. The DST switch point is specified by the month, week of the month and weekday. By default, DST starts at 2:00 AM on the first Sunday in April of each year.
DST end month DST end week DST end weekday DST end Hour	Month-week-weekday-hour Month = Jan-Dec Week = 1 st , 2 nd , 3 rd , 4 th or Last (last week of the month) Day = Mon-Sun Hour = 1-6	November First Sunday 2	The DST end date when Daylight Savings Time ends. The DST switch point is specified by the month, week of the month and weekday. By default, DST ends at 2:00 AM on the last Sunday in November of each year.
Clock Synchronization			
Time synchronization input	GPS IRIG-B, SNTP, DI1-DI26(digital input 1-26)	----	The external port receiving the time synchronization signal. If no external synchronization is used, set this option to IRIG-B: when a signal is not present, the PM335 PRO automatically uses internal RTC clock for time synchronization.

Time Synchronization Source

The PM335 PRO receives the time synchronization signal either from a GPS clock having an IRIG-B time-code output, or from an external device giving a pulse at the beginning of the minute. If the IRIG-B option is selected but the IRIG-B signal is not present on the device input, the PM335 PRO automatically uses its internal RTC clock.

Using the IRIG-B

To use the IRIG-B input, select the GPS IRIG-B option and connect the GPS master clock to the IRIG-B BNC connector on the front of the PM335 PRO IRIG-B Module.

When the IRIG-B signal is present on the device input, the PM335 PRO automatically synchronizes its clock with the GPS time each second, normally with accuracy better than 1 millisecond if the time is locked to the GPS satellite time. If the GPS clock loses the satellite signal, the clock continues to generate the IRIG-B time code referenced to the last available satellite time, but the time quality may get worse. Such signal losses can last from a few minutes to hours. During such outages the time code generated by the GPS receiver is typically accurate to within a few milliseconds over a 24-hour period.

If the IRIG-B signal is lost, the PM335 PRO changes the time synchronization source to the internal RTC in 5 minutes. When the IRIG-B signal is restored, the device automatically acquires the GPS time.

If the IRIG-B signal is lost or time code quality changes (locked to the GPS satellite time or unlocked), the corresponding events are automatically recorded to the device Event log.

Using SNTP

Enable SNTP client operation and configure it if required (see Setting-Up SNTP Client).

When an SNTP server is not available or when a connection with a server is restored, the corresponding event is automatically recorded to the device Event log.

Using External Minute Pulses

External time synchronization pulses are delivered through one of the PM335 PRO digital inputs. If the digital input is selected as the time synchronization source, the external pulse's edge adjusts the device clock at the nearest whole minute. The time accuracy is affected by the debounce time programmed for the digital input, and by the operation delay of the external relay.

Resolution setting

This display setup menu allows the user to setup the voltage, current, power and energy display resolution (V or kV, A or kA, kW or MW and kWh or MWh).

Access Display Setup menu, Select Resolution and setup the device electrical parameter value resolution as described below using UP/DOWN navigation buttons and OK/ENTER button.

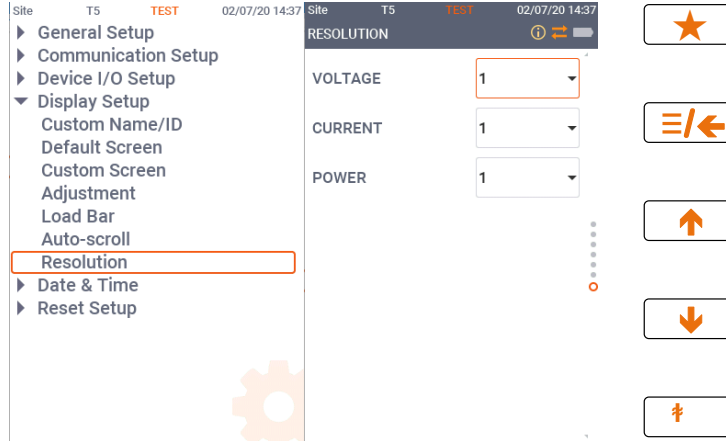

Note:

The EM235 display menus is identical to the PM335 display menus

Chapter 7 Configuring Recorders

The EM235/PM335 PRO is equipped with a 16GBytes onboard non-volatile memory for data, event and waveform recording.

Before using recorders, the device memory must be partitioned between log files. The device memory is fully configurable; you can define how much memory to allocate for each log file. If you want to change the factory settings, follow the guidelines in the section below.

Configuring Device Memory

The PM335 PRO memory can be partitioned for a total of 28 log files:

- Event log
- 16 Data logs
- 8 Waveform logs
- PQ log

To view the device memory settings, select Memory/Log from the Meter Setup menu, and then click on the Log Memory tab.

No.	File	Type	Size, Bytes	Sections/ Channels	Max. Records	Max. Events	Record Size	Para- meters	Logged Records
1	Event Log	Wrap-around	20000		1000	1000	20		108
2	Data Log 1	Wrap-around	3072000		38400	38400	80	16	931
3	Data Log 2	Wrap-around	3072000		38400	38400	80	16	686
4	Data Log 3	Free							
5	Data Log 4	Free							
6	Data Log 5	Free							
7	Data Log 6	Free							
8	Data Log 7	Free							
9	Data Log 8	Free							
10	Data Log 9	Free							
11	Data Log 10	Free							
12	Data Log 11	Free							
13	Data Log 12	Free							
14	Data Log 13	Wrap-around	520000		10000	10000	52	9	0
15	Data Log 14	Wrap-around	520000		10000	10000	52	9	301
16	Data Log 15	TOU Monthly Profile	6144	4	48	48	32	4	2

Figure 7-1: Memory Setup Dialog Box – Log Setup

The following table shows available file options.

Table 20: Log Files Setup options

Option	Format/Range	Description
Type	Wrap around, Non-wrap TOU Monthly Profile TOU Daily Profile	Defines the file behavior when it is filled up. Wrap around: recording continues over the oldest records. Non-wrap: recording is stopped until the file is cleared. TOU Monthly Profile: monthly TOU profile data log (only for data log #15). Wrap around by default. TOU Daily Profile: daily TOU profile data log (only for data log #16). Wrap around by default.
Size		Shows the size of the memory allocated to the file. It is set automatically depending on the size of a file record and the number of records in the file.
Sections/Channels	0-32	Defines the numbers of sections in a multi-section TOU profile data log file or the number of recording channels in a waveform log file
Num. of Records	0-65535	Allocates the file memory for a predefined number of records
Record size		Shows the size of the file record for a single channel or section. It is set automatically depending on the file and on the number of parameters in the data record
Parameters		Defines the number of parameters in a single data record for data log files.

Memory is allocated for each file statically and does not change unless you re-organize the files. The PM335 PRO automatically performs de-fragmentation of the memory each time the file allocation changes. This helps keep all free memory in one continuous block, and thus prevents possible leakage of memory caused by fragmentation.

Data log files #15 and #16 may be configured to record TOU monthly profile and TOU daily profile data on a daily or monthly basis.

To change the file properties or to create a new file:

1. Double click on the file partition you want to change, or highlight the file row, and then click on the "Configure File" button.
2. To change the file properties, select desired parameters, and then click OK. For your reference, the record size and the number of records available for the file are reported in the dialog box.
3. To delete a file partition, click on Delete, and then click OK.
4. Send your new setup to the device.

The following table shows how to calculate a file size for different files.

File	Record Size, Bytes	File Size, Bytes
Event Log	20	Record Size × Number of Records
Data Log	12 + 4 × Number of Parameters	Record Size × Number of Records
TOU Profile Log (Data log #15-#16)	12 + 4 × Number of Season Tariffs	Record Size × Number of TOU Registers × Number of Records × 2
Waveform Log	1072	Record Size × Number of Channels × Number of Series × Number of Records per Series
PQ Log	32	Record Size × Number of Records

For more information on configuring specific files, see following sections.

The device memory is pre-configured for regular data trending and fault recording applications as shown in the following table.

No.	File	Type	Size, Bytes	Sections /Channel	Max. of Records	Max. of Events	Description
1	Event log	Wrap around	40000		2000	2000	
2	Data log #1	Wrap around	3072000		38400	38400	Configured for continuous data recording
3	Data log #2	Wrap around	3072000		38400	38400	Configured for continuous data recording
10	Data log #3	free					
...
14	Data log #13	free					
15	Data log #14 (PQ data trend)	Wrap around	520000		10000	10000	Used by the PQ recorder
24	Waveform log #7	Wrap around	4288000	10	4000	1000	Used by the PQ and Fault recorders
25	Waveform log #8	Wrap around	1715200	8	2000	500	Used by the PQ recorder
27	PQ log	Wrap around	640000		20000	20000	

The device memory is pre-configured for regular data trending and fault recording applications as shown in the following table.

Configuring the Event Recorder

To change the Event log file size:

1. Select Memory/Log from the Meter Setup menu, and then click on the Log Memory tab.
2. Double click on the Event log file partition with the left mouse button.

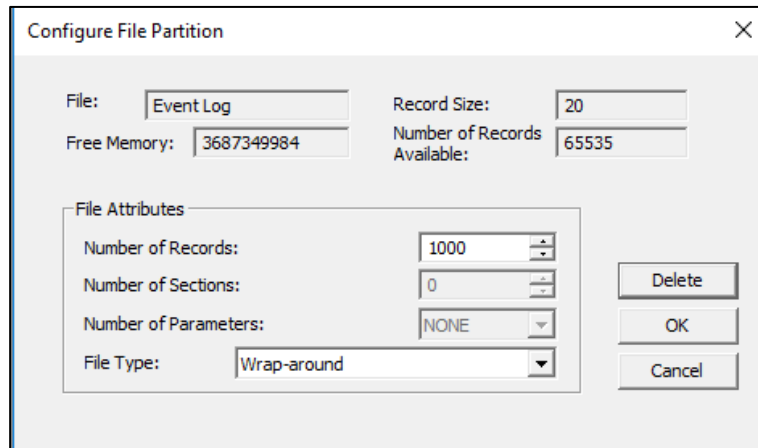

Figure 7-2: Memory/Log Setup Dialog Box – Event Log configure file partition

3. Select a file type.
4. Select the maximum number of records you want to be recorded in the file.
5. Click OK, and then send your new setup to the device or save to the device database.

By default, the Event recorder stores all events related to configuration changes, reset, and device diagnostics. In addition, it records events related to setpoints operations. Each setpoints should be individually enabled for recording to the Event log.

To log setpoints operations, add the “Event log” action to the setpoints actions list. Put the event log action at the beginning of the list to allow other recorders to use the sequence number assigned to the event for cross-linking between records logged to different files. When a setpoints event happens, the Event recorder logs all setpoints conditions that caused the event and all setpoints actions performed in response to the event.

Configuring the Data Recorder

The Data recorder is programmable to record up to 16 data parameters per record in each of 14 data log files (TOU Monthly Profile & TOU Daily Profile data log files may include up to 9 parameters). The list of parameters to be recorded to a data log is configured individually for each file.

Conventional Data Log Files

To create a new data log file or re-configure an existing file:

1. Select Memory/Log from the Meter Setup menu, and then click on the Log Memory tab.
2. Double click on the file partition with the left mouse button.
3. Select a file type.
4. Select the number of parameters to be recorded in the file records.
5. Select the maximum number of records to be recorded in the file.
6. Click OK, and then send your new setup to the

device, or save to the device database.

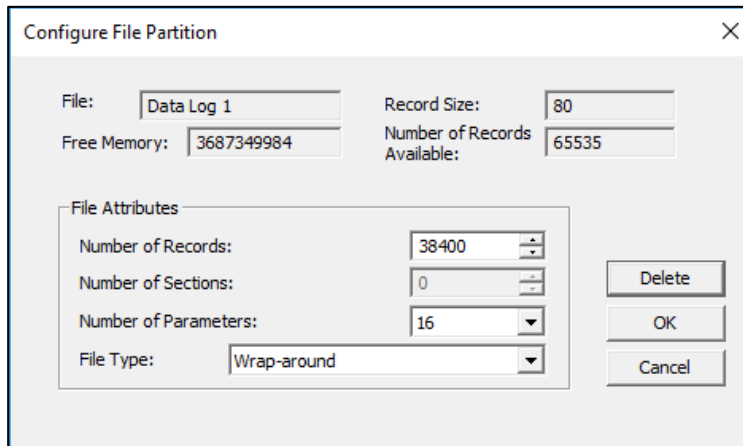

Figure 7-3: Memory/Log Setup Dialog Box – Data Log 1 configure file partition

7. Highlight the data log file row with the left mouse button, and then click on the “Setup Recorder” button, or click on the “Data Recorder” tab and select the log number corresponding to your file.

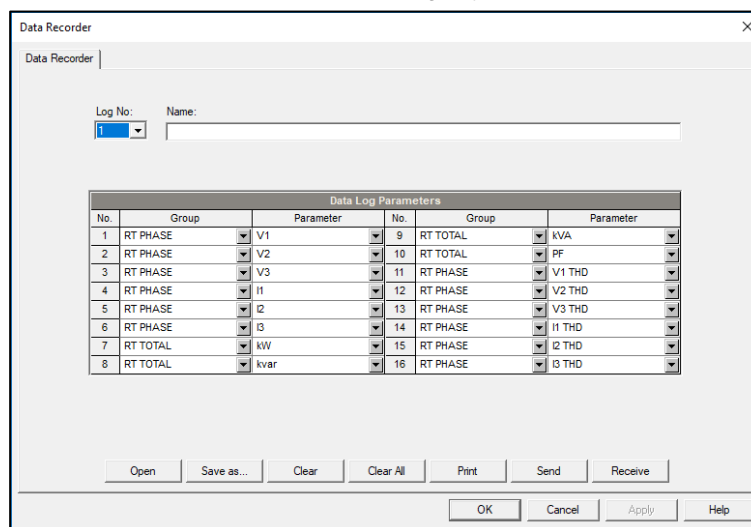

Figure 7-4: Memory/Log Setup Dialog Box – Data Log 1 setup recorder

8. Configure the list of parameters to be recorded in the data log file. You are not allowed to select more parameters than you defined when configuring your file. Refer to chapters 17/18 for a list of available parameters.

For your convenience, PAS follows your selection and helps you to configure a series of the neighboring parameters: when you open the “Group” box for the next parameter, PAS highlights the same group as in your previous selection; if you select this group again, PAS automatically updates the “Parameter” box with the following parameter in the group.

9. Add the name for your data log file in the “Name” box. It will appear in the data log reports.
10. Save your new setup to the device database, and send it to the device.

Factory Preset Periodic Data Logs

Data logs #1 and #2 are factory preset for periodic recording of the standard power quantities as shown in the following table.

No.	Parameter	No.	Parameter
Data Log #1			
1	RT (1-cycle) V1	9	RT (1-cycle) Total kVA
2	RT (1-cycle) V2	10	RT (1-cycle) Total PF
3	RT (1-cycle) V3	11	RT (1-cycle) V1 THD
4	RT (1-cycle) I1	12	RT (1-cycle) V2 THD
5	RT (1-cycle) I2	13	RT (1-cycle) V3 THD
6	RT (1-cycle) I3	14	RT (1-cycle) I1 THD
7	RT (1-cycle) Total kW	15	RT (1-cycle) I2 THD
8	RT (1-cycle) Total kvar	16	RT (1-cycle) I3 THD
Data Log #2			
1	kW Import Sliding Demand	9	I1 Demand
2	kvar Import Sliding Demand	10	I2 Demand
3	KVA Sliding Demand	11	I3 Demand
4	kWh Import	12	V1 Demand
5	kWh Export	13	V2 Demand
6	kvarh Import	14	V3 Demand
7	kvarh Export	15	RT (1-cycle) I4
8	kVAh	16	RT (1-cycle) V4

Setpoints #1 is preset at the factory to trigger Data logs #1 and #2 in 15 min intervals.

Factory Preset Fault and PQ Data Logs

Data log #14 is factory preset for RMS trending on the power quality events and is intended for the use with the PQ recorders. The default PQ data log configuration is shown in the following table.

No.	Parameter	No.	Parameter
Data Log #14 (PQ data trend)			
1	Generic V1	9	
2	Generic V2		
3	Generic V3		
4	Generic I1		
5	Generic I2		
6	Generic I3		
7	Generic FREQ		
8			

The generic data group represents generic volts, amps, etc., regardless of the data integration time. The PQ recorder can use different time envelopes to record data integrated over intervals from a half cycle to 10 minutes depending on the duration of the power quality event (see [Configuring the Power Quality Recorder](#)). The Fault recorder uses only the half-cycle RMS trend.

TOU Profile Data Log Files

Data log files #15 and #16 are configurable to store the TOU monthly profile log and the TOU daily profile log respectively.

A TOU profile log file is organized as a multi-section file that has a separate section for each TOU energy

and maximum demand register. The number of sections is taken automatically from the Summary/TOU Registers setup (see [Configuring Summary and TOU Registers](#) in Chapter 8). Since each TOU energy register has a shadow maximum demand register, the number of sections in the file is twice the number of the allocated TOU registers.

In order to correctly allocate the memory space for TOU profile log files, assign TOU registers before you set up your TOU profile log files.

To configure a TOU daily profile log file:

1. Configure your TOU registers and TOU schedule before allocating memory for a profile log file (see [Configuring Summary and TOU Registers](#) in Chapter 8).
2. Select Memory/Log from the Meter Setup menu, and then click on the Log Memory tab.
3. Double click on the Data Log #15 or Data Log #16 partition row.

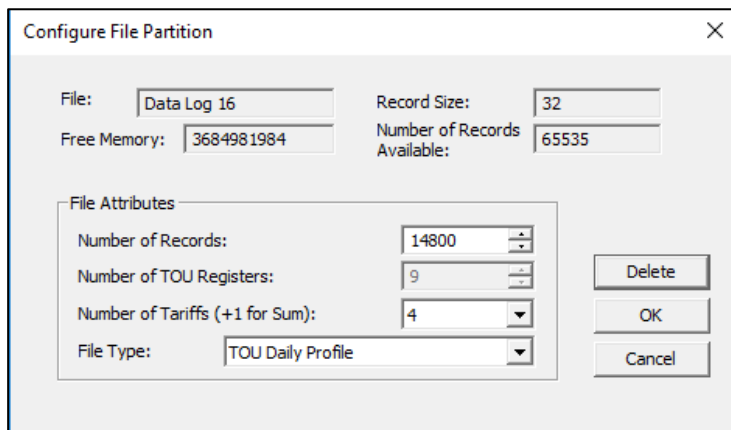

Figure 7-5: Memory/Log Setup Dialog Box – Data Log 16 configure file partition

4. Select the TOU Monthly Profile or TOU Daily Profile in the File Type box.
5. Select the number of season tariffs in your TOU schedule.
6. Select the maximum number of records you want to be recorded in the file assuming that a new record is added once a month or once a day.
7. Click OK and send your setup to the device or save to the database.

Configuring the Waveform Recorder

Waveform log files are organized as multi-section files that store data for each recording channel in a separate section.

A regular waveform log file records up to 7 analog channels simultaneously: seven AC channels (three voltages and four currents), and up to 26 digital inputs DI1-DI16, DI17-DI32 and DI33-DI48 organized in three sections as three 16-bit analog channels.

A single channel waveform record contains 512 points of the sampled input signal. If a waveform log is configured to record more samples per event than a single record can hold, the waveform recorder stores as many records per event as required to record the entire event. All waveform records related to the event are merged in a series and have the same series number, so they can be plotted together.

The PM335 PRO supports 8 waveform files that can record waveforms at four programmable sampling rates: 32, 64, 128 or 256 samples per cycle.

To configure a waveform log file:

1. Select Memory/Log from the Meter Setup menu, and then click on the Log Memory tab.

2. Double click on a waveform log partition with the left mouse button.
3. Select a file type for your file.
4. Select the maximum number of records to be recorded in the file.

The number of records in the waveform log file needed to store one waveform event (series) is defined as follows:

$$\text{Number of Records per Series} = \text{Sampling Rate (Samples per Cycle)} \times \text{Number of Cycles per Event} / 512$$

The total number of records you must allocate to store the required number of events (series) is defined as follows:

$$\text{Number of Records} = \text{Number of Records per Series} \times \text{Number of Series}$$

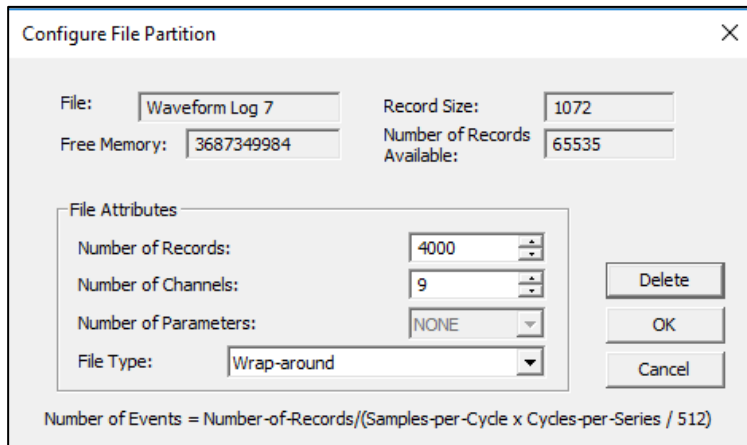

Figure 7-6: Memory/Log Setup Dialog Box – Waveform Log 7 configure file partition

For example, if you want to record a 64-cycle waveform sampled at a rate of 32 samples per cycle, the number of records required for one waveform series would be:

$$\text{Number of Records per Series} = (32 \times 64) / 512 = 4.$$

If you want to allocate space sufficient to store 20 waveform events (series), you should set up the waveform log file for $4 \times 20 = 80$ records.

5. Click OK, and send your setup to the device or save to the database.
6. Click “Setup Recorder”, or click on the “Waveform Recorder” tab.

The following table lists available waveform options.

Option	Range	Description
Samples per Cycle	32, 64, 128, 256 samples/cycle	Defines the sampling rate for the waveform log
Cycles per Series	16-10848 (32 samples/cycle), 8-5424 (64 samples/cycle), 4-2712 (128 samples/cycle) 2-1356 (256 samples/cycle)	Defines the total duration of the waveform recording per event/series
Before Cycles	1-20	Defines the number of cycles to be recorded prior to the event
Num. of Channels	1-26	The number of the simultaneously recorded channels

7. Select the sampling rate for waveforms.
8. Select the number of cycles to be recorded prior to the event, and a total number of cycles in the waveform.
9. Add the name for your waveform log file in the “Name” box. It will appear in the waveform reports.

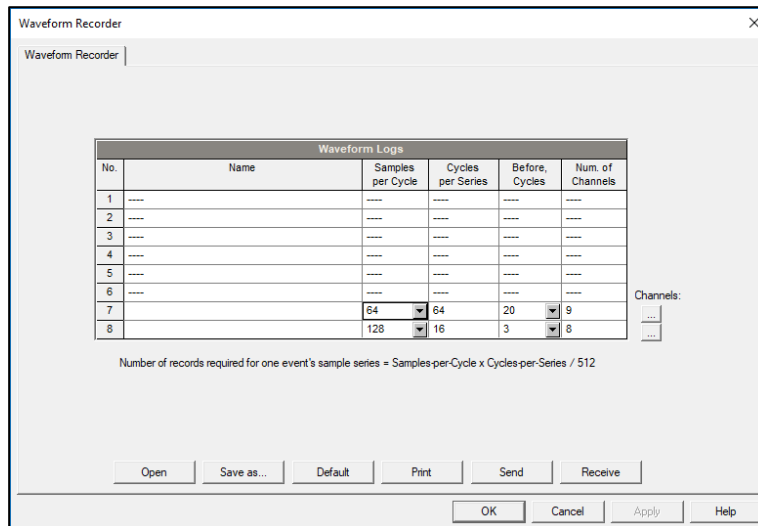

Figure 7-7: Memory/Log Setup Dialog Box – Waveform Log 7 setup recorder

- To select the channels, click on the “Channels” button, check the boxes for channels to be recorded, and then click OK.

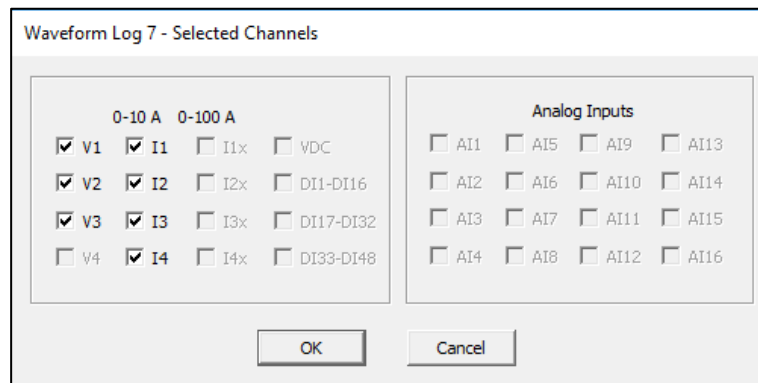

Figure 7-8: Memory/Log Setup Dialog Box – Waveform Log 7 selected channels

- Save your waveform setup to the site database, and send it to the device.

The picture above shows the factory preset waveform logs. Waveform log #7 is used with the PQ events and PQ transient and short duration events. Waveform log #8 is used with the PQ recorder to store waveforms related to harmonics events.

Configuring the Power Quality Recorder

The Power Quality (PQ) recorder identifies the power quality events according to predefined parameters limits and records them to the log file with the precise start and end timestamps and a fault magnitude.

Impulsive transients and short-duration voltage variations (sags and swells) can also be viewed as magnitude/duration pairs on the well-known ITIC curve chart for assessing the minimum equipment immunity.

The PQ recorder can trigger the waveform recorder to record the fault waveforms before, during and after the PQ event for detailed event analysis. It may be useful for troubleshooting problems throughout electrical networks, for example, to identify and locate the source of a power quality event and to select an appropriate solution.

PQ Events Evaluation

The events are classified in accordance with the IEEE 1159 power quality categories. The table below shows the categories recorded by the device, the metering data used to detect voltage and frequency faults, their typical triggering thresholds and event durations.

Impulsive transients

Impulsive transients are detected as impulses with a rise time less than 0.5 ms and duration from 80 us to ½ cycle. The impulse magnitude is measured as the overshoot voltage magnitude above the normal voltage wave shape. It is referenced to the nominal peak voltage (1.414 Un).

Sags and swells

A voltage sag or swell is classified as one polyphase event regardless of the shape and of the number of phases affected (as per IEC 61000-4-30). An event can begin on one phase and end on another phase. The fault magnitude is recorded separately for each phase involved. The event duration is measured from the instant at which the voltage falls/rises below/above the start threshold on one of the phases to that at which it becomes greater/lower than the end threshold on all affected phases including a threshold hysteresis.

Voltage Interruptions

The voltage interruption is detected when the voltages on all phases fall below the interruption threshold (as per IEC 61000-4-30).

Event ID	PQ category	Trigger parameter	Reference value	Typical thresholds, %	Event duration
PQE11	Impulsive transients	Instantaneous overshoot voltage	Un peak voltage	20-200%	80 us–10 ms
PQE211	Instantaneous sag	½ cycle RMS voltage	Un RMS	80-90%	< 30 cycles
PQE212	Instantaneous swell	½ cycle RMS voltage	Un RMS	110-120%	< 30 cycles
PQE221	Momentary interruption	½ cycle RMS voltage	Un RMS	0-10%	< 3 sec
PQE222	Momentary sag	½ cycle RMS voltage	Un RMS	80-90%	< 3 sec
PQE223	Momentary swell	½ cycle RMS voltage	Un RMS	110-120%	< 3 sec
PQE231	Temporary interruption	½ cycle RMS voltage	Un RMS	0-10%	< 1 min
PQE232	Temporary sag	½ cycle RMS voltage	Un RMS	80-90%	< 1 min
PQE233	Temporary swell	½ cycle RMS voltage	Un RMS	110-120%	< 1 min
PQE31	Sustained interruption	½ cycle RMS voltage	Un RMS	0-10%	> 1 min
PQE32	Undervoltage	½ cycle RMS voltage	Un RMS	80-90%	> 1 min
PQE33	Overvoltage	½ cycle RMS voltage	Un RMS	110-120%	> 1 min
PQE4	Voltage unbalance	3-sec negative sequence unbalance	No	1-5%	Steady state
PQE52	Harmonics THD	3-sec harmonic THD	No	5-20%	Steady state
PQE53	Interharmonics THD	3-sec interharmonic THD	No	2-8%	Steady state
PQE6	Voltage fluctuations (flicker)	10-min Pst	No	1-5	Steady state
PQE7	Frequency variations	3-sec frequency	Nominal frequency	1-6%	Steady state

Un – nominal device voltage

PQ Recorder Setup

The PQ recorder setup allows you to adjust thresholds and hysteresis for PQ triggers, to define the waveform and data log options for PQ events, and to enable or disable the PQ recorder in your device.

To configure the PQ recorder:

1. Select Memory/Log from the Meter Setup menu, and then click on the PQ Recorder tab.
2. If you want to change the default settings, adjust thresholds and hysteresis for PQ triggers
3. Select the waveform and data logging options for PQ events
4. Download your setup to the device.

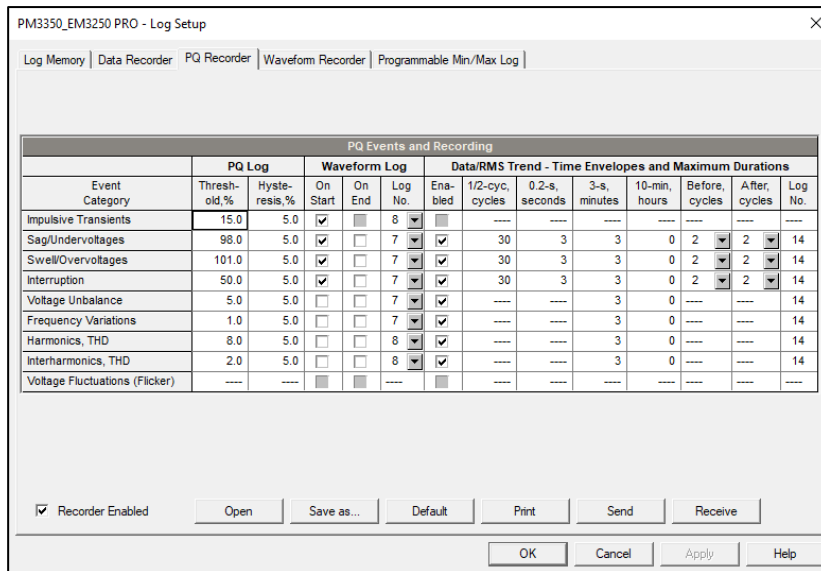

Figure 7-9: Memory/Log Setup Dialog Box – PQ recorder setup

The available PQ recorder options are shown in the following table:

Option	Range	Default	Description
Thresholds			
Threshold, %	0-200.0%		Defines the operating threshold for the PQ trigger in percent of the nominal (reference) value
Hysteresis, %	0-50.0%	5.0	Defines the hysteresis for PQ trigger in percent of the threshold
Waveform Log			
On Start	Checked Unchecked	Checked	Enables waveform log when the PQ event starts
On End	Checked Unchecked	Unchecked	Enables waveform log when the PQ event ends
Log No.	1-8	7	Specifies the waveform log file used for waveform recording on the PQ event
Data/RMS Plot			
Enabled	Checked Unchecked	Unchecked	Enables concurrent RMS trace plot to the data log file while the PQ event continues
1/2-cyc	0-10,000 cycles	30	Duration of the 1/2-cycle data trace
0.2-sec	0-10,000 seconds	3	Duration of the 0.2-second data trace
3-sec	0-10,000 minutes	3	Duration of the 3-second data trace
10-min	0-10,000 hours	0	Duration of the 10-minute data trace
Before, Cycles	0-20 cycles	2	The number of cycles to be recorded prior to the event
After, Cycles	0-20 cycles	2	The number of cycles to be recorded after the event

Option	Range	Default	Description
Log No.	14		Specifies the data log file used for data recording on the PQ event

The Sag, Swell and Interruption triggers use the same waveform and data log options. If you change one of them, the others are automatically adjusted to the same setting.

The waveform log option allows recording waveforms both at the start and the end of a PQ event. Since the voltage variations may last from some seconds to minutes, this allows capturing and analyzing the voltage transitions using short time waveform recording at the start and the end of the voltage sag or swell.

The data log option allows concurrent recording of the RMS data at a variable rate depending on the PQ event duration. To reduce the memory consumption for recording long duration events, the PQ recorder uses different time envelopes (aggregation intervals) for data tracing and changes the recording rate accordingly. You can specify for each PQ trigger how much time to record data using one or more time envelopes.

To enable or disable the PQ recorder:

1. Check or uncheck the "Recorder Enabled" checkbox.
2. Send your setting to the device.

Power Quality Event Indication and Cross Triggering

When the PQ recorder detects a power quality fault, it generates the specific internal event PQ EVENT that can be monitored through a control setpoints to give a fault indication via relay contacts. The event can be found under the STATIC EVENTS group in the setpoints trigger list.

The power quality fault signal is used for cross triggering multiple recorders through a dedicated digital input in order to simultaneously record disturbances at different locations. External triggering of the Waveform and Data recorders for recording disturbance data can be done through a setpoints programmed to monitor the status of a digital input. For more information on cross triggering, see [Fault Indication and Cross Triggering](#).

Chapter 8 Totalization Energy and TOU Registers

The PM335 PRO provides 16 summary energy registers and 16 parallel TOU energy and maximum demand registers to link to any internal energy source or to any external pulse source that delivers energy pulses through the device digital inputs.

A total of 64 energy sources can be connected to the summary and TOU registers. Each summary register can accumulate energies from multiple sources using arithmetic addition and subtraction. A summary register may be linked to another summary register to provide more comprehensive energy calculations.

The TOU system provides for each TOU energy register a parallel maximum demand register that is updated automatically when a corresponding TOU register is activated. The device supports 16 different tariffs using an arbitrary tariff structure.

The PM335 PRO TOU system technique is based on the currently active TOU annual calendar that assigns the user-selectable daily profile to each day of the year. The TOU daily profiles specify daily tariff change points. The PM335 PRO memory stores calendars for 10 years. A total of 16 types of days are supported with up to eight tariff changes per day.

By default, the summary registers in your device are not linked to energy sources and are not operational. To activate a summary energy register, link it to the energy source(s).

To activate TOU system:

1. Configure the TOU daily profiles for different types of days.
2. Configure the TOU calendars.
3. Link the TOU registers to the corresponding summary energy registers that are used as source registers for TOU system.

Configuring Summary and Bill./TOU Reg.

To configure the device summary and Billing/TOU registers, select Energy/TOU from the Meter Setup menu.

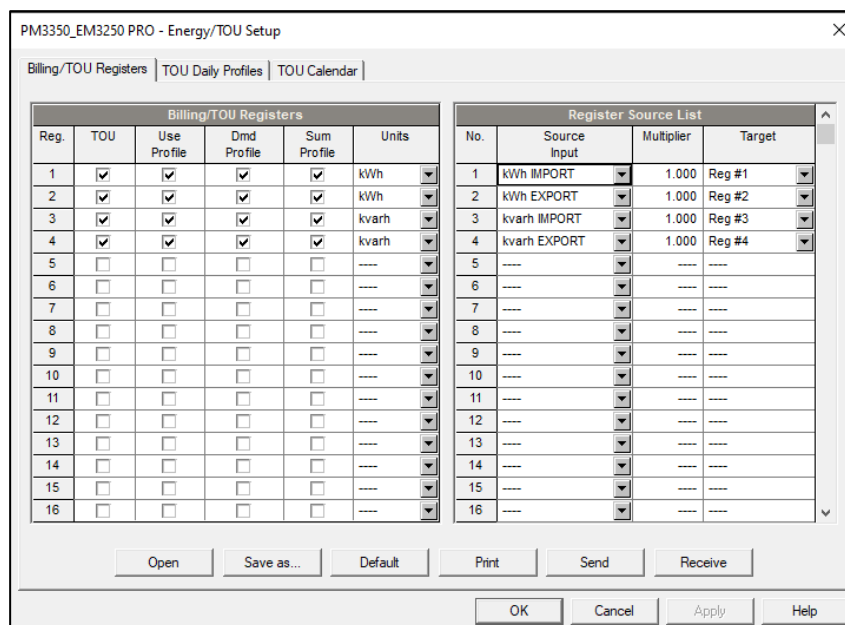

Figure 8-1: Energy/TOU Setup Dialog Box – Billing/TOU Registers setup

The available options are described in the following table:

Parameter	Options	Default	Description
Billing/TOU Registers			
TOU	Unchecked Checked	Unchecked	Links multi-tariff registers to the selected energy source

Parameter	Options	Default	Description
Use Profile	Unchecked Checked	Unchecked	Enables recording energy registers in monthly/daily billing profile files (both total and tariff registers if TOU is enabled).
Dmd Profile	Unchecked Checked	Unchecked	Enables recording maximum demand registers in monthly/daily billing profile files (both total and tariff registers if TOU is enabled)
Sum Profile	Unchecked Checked	Unchecked	Enables recording total (summary) registers in monthly/daily billing profile files.
Units	None kWh kvarh kVAh m3 CF CCF	None	The energy register measurement unit.
Register Source List			
Source Input	None kWh IMPORT KWh EXPORT kvarh IMPORT kvarh EXPORT kvarh Q1 kvarh Q2 kvarh Q3 kvarh Q4 kVAh TOTAL kVAh IMPORT kVAh EXPORT L1 kWh IMPORT L2 kWh IMPORT L3 kWh IMPORT L1 kWh EXPORT L2 kWh EXPORT L3 kWh EXPORT L1 kvarh IMPORT L2 kvarh IMPORT L3 kvarh IMPORT L1 kvarh EXPORT L2 kvarh EXPORT L3 kvarh EXPORT L1 kVAh TOTAL L2 kVAh TOTAL L3 kVAh TOTAL DI1-DI26 SUMM REG #1 - 16	None	Links an internal or external energy source to the billing register.
Multiplier	0.001 to 100.000	1.000	The multiplication factor for the energy source.
Target	Reg#1- Reg#10	None	Defines the target summary register for the energy source.

Configuring TOU Daily Profiles

The PM335 PRO TOU calendar provides a season tariff schedule and an option for scheduled daylight savings switch dates.

To configure the TOU daily profiles, select Energy/TOU from the Meter Setup menu, and then click on the TOU Daily Profiles tab.

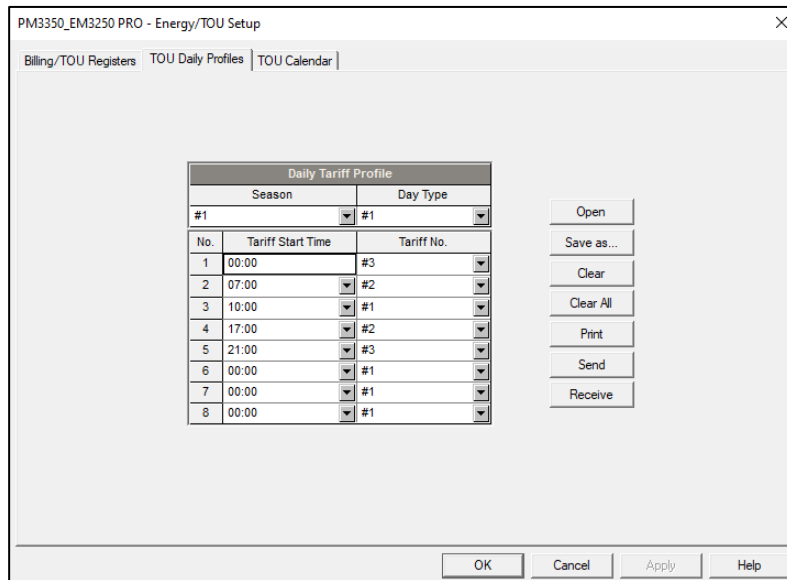

Figure 8-2: Energy/TOU Setup Dialog Box – TOU Daily Profiles setup

The profile setup allows you to specify the daily tariff change points with a 15-minute resolution.

To configure your daily profiles:

1. Select the desired season and day type
2. Select the start time for each tariff change point and the corresponding active tariff number.
3. Repeat the setup for all seasons and types of day.

The first tariff change point is fixed at 00:00 hours, and the last tariff change you specified will be in use until 00:00 hours on the next day.

Note: The billing monthly and daily profile files, and your billing data display are automatically configured for the number of active tariffs you defined in the meter TOU daily profile

Configuring TOU Calendar

The PM335 PRO TOU calendar provides a season tariff schedule and an option for scheduled daylight savings switch dates.

To configure your season tariff schedule, select Energy/TOU from the Meter Setup menu, and then click on the TOU Calendar tab.

No.	Season/Period	Day Type	Week of Month	Weekday	Till Weekday	Month	Day	Till Month	Till Day	Year
1	#1	#1	---	Sunday	Thursday	July	---	August	---	---
2	#1	#2	---	Friday	---	July	---	August	---	---
3	#1	#3	---	Saturday	---	July	---	August	---	---
4	#2	#1	---	Sunday	Thursday	December	---	February	---	---
5	#2	#2	---	Friday	---	December	---	February	---	---
6	#2	#3	---	Saturday	---	December	---	February	---	---
7	#3	#1	---	Sunday	Thursday	March	---	June	---	---
8	#3	#2	---	Friday	---	March	---	June	---	---
9	#3	#3	---	Saturday	---	March	---	June	---	---
10	#3	#1	---	Sunday	Thursday	September	---	November	---	---
11	#3	#2	---	Friday	---	September	---	November	---	---
12	#3	#3	---	Saturday	---	September	---	November	---	---
13	#1	#1	---	---	---	January	---	January	---	2001
14	---	---	---	---	---	---	---	---	---	---
15	---	---	---	---	---	---	---	---	---	---
16	---	---	---	---	---	---	---	---	---	---

Figure 8-3: Energy/TOU Setup Dialog Box – TOU Calendar setup

The meter TOU calendar allows you to configure any tariff schedule based on any possible utility regulation. The calendar provides 48 entries that allow you to specify profiles for working days and holidays through all seasons in any order that is convenient for you, based on simple intuitive rules. There are no limitations on how to define your schedule. The meter is able to automatically recognize your settings and to select a proper daily tariff schedule for any day within a year.

To configure your season tariff schedule:

1. In the “Season/Period” box, select the season, and in the “Day Type” box, select a day type for this calendar entry.
2. Select the time interval when this daily tariff schedule is effective, based on the start and the end weekdays and, for a multi-season schedule, on the start and the end month for the selected season. It does not matter which order of weekdays or months you select: the meter recognizes the correct order.
3. For exception days like designated holidays, select a specific day either by specifying a day and month, or by selecting a month, a week and a weekday within the month.

NOTE: The PM335 PRO TOU calendar provides an embedded schedule of Hebrew holidays till 2039 for Israeli customers. To enable the automatic holiday schedule, select Israel in the Country box in the Local Settings setup (see Local Settings)

To configure your DST schedule:

1. Select DST in the “Season/Period” box.
2. Select the DST start month and day in the “Month” and “Day” boxes.
3. Select the DST end month and day in the “Till Month” and “Till Day” boxes.
4. In the “Year” box, select a year for which these dates will be effective.

5. Repeat steps 2-4 for all years for which you wish to provide a DST schedule.

To make your DST schedule effective:

1. Go to the Local Settings setup (see Local Settings).
2. Select "Scheduled" in the Daylight Saving Time (DST) box.
3. Send your new setting to the meter.

Chapter 9 Configuring Communication Protocols

- This section describes how to customize protocol options for use with your application software.

Configuring Modbus

Modbus Point Mapping

The PM335 PRO provides 120 user assignable registers at addresses 0 to 119. You can re-map any register available in the meter to any assignable register so that registers found at different locations may be accessed with a single request by re-mapping them to adjacent addresses.

Initially these registers are reserved and none of them points to an actual data register. To build your Modbus register map:

- Select Protocol Setup from the Meter Setup menu, and click on the Modbus Registers tab.
- Click on the Default button to cause the assignable registers to reference the actual default meter register 6656 (0 through 119 are not allowable register addresses for re-mapping).

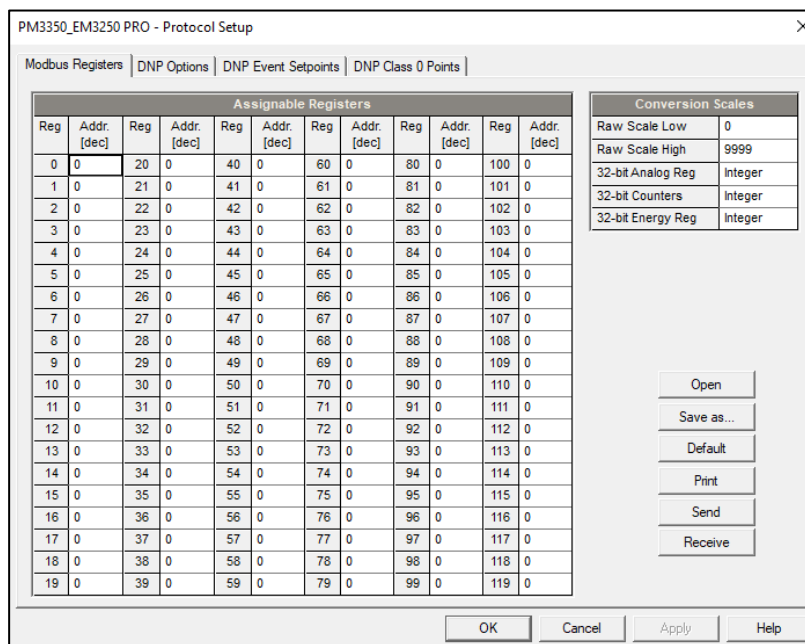

Figure 9-1: Protocol Setup Dialog Box – Modbus Registers Tab

- Type in the actual addresses you want to read from or write to via the assignable registers. Refer to the PM335 PRO Modbus Reference Guide for a list of the available registers. Note that 32-bit Modbus registers should always start at an even register address.
- Click Send to download your setup to the meter.

Changing 32-bit Register Format

The PM335 PRO allows you to read 32-bit Modbus analog registers, energy counters and binary counters either in integer format, or in IEEE single precision floating point format.

The 32-bit Modbus registers are factory-set to integer format. To change the register format:

- Select Protocol Setup from the Meter Setup menu, and click on the Modbus Registers tab.
- Change the 32-bit register format in the Modbus Options pane.
- Click Send to download your setup to the meter.

Configuring DNP3

Refer to the PM335 PRO DNP3 Reference guide for information on the DNP3 protocol implementation and a list of the available data points.

DNP Options

Select Protocol Setup from the Meter Setup menu and click on the DNP Options tab.

The screenshot shows the 'PM3350_EM3250 PRO - Protocol Setup' dialog box with the 'DNP Options' tab selected. The dialog is divided into several sections:

- Binary Inputs (BI):** Number of BI to generate events: 21; Default Binary Input Object: Single-bit; Binary Input Change Event Object: With Time.
- Analog Inputs (AI):** Number of AI to generate events: 43; Default Analog Input Object: 16-bit -Flag; Analog Input Change Event Object: 16-bit +Time; Default Frozen Analog Input Object: N/A; Frozen Analog Change Event Object: N/A.
- Binary Counters (BC):** Number of BC to generate events: 0; Default Binary Counter Object: 32-bit -Flag; Binary Counter Change Event Object: 32-bit +Time; Default Frozen Binary Counter Object: 32-bit -Flag; Frozen Counter Change Event Object: N/A.
- DNP General Options:** 16-bit AI Scaling: Enabled; 16-bit BC Scaling: x1; Re-mapping Event Points: Disabled; SBO Timeout, s: 10; Time Sync Period, s: 86400; Multi Fragment Interval, ms: 50; Location: Station; Max. Directory Entries: 20.

Buttons at the bottom include Open, Save as..., Default, Print, Send, Receive, OK, Cancel, Apply, and Help.

Figure 9-2: Protocol Setup Dialog Box – DNP Options Tab

The following table describes available options. Refer to the DNP3 Data Object Library document available from the DNP User's Group on the DNP3 object types.

Table 21: DNP Options

Parameter	Options	Default	Description
Binary Inputs (BI)			
Binary Input Object	Single-bit With Status	Single-bit	The default BI object variation for requests with qualifier code 06 when no specific variation is requested
Analog Inputs (AI)			
Analog Input Object	32-bit 32-bit-Flag 16-bit 16-bit-Flag	16-bit-Flag	The default AI object variation for requests with qualifier code 06 when no specific variation is requested
Binary Counters (BC)			
Binary Counter Object	32-bit+Flag 32-bit-Flag 16-bit+Flag 16-bit-Flag	32-bit-Flag	The default BC object variation for requests with qualifier code 06 when no specific variation is requested
DNP General Options			
16-bit AI Scaling	Disabled Enabled	Enabled	Allows scaling 16-bit analog input objects (see description below)
16-bit BC Scaling	x1, x10, x100, x1000	x1	Allows scaling 16-bit binary counter objects (see description below)

Parameter	Options	Default	Description
SBO Timeout ³	2-30 sec	10	Defines the Select Before Operate (SBO) timeout when using the Control-Relay-Output-Block object
Time Sync Period ⁴	0-86400 sec	86400	Defines the time interval between periodic time synchronization requests
Multi Fragment Interval	50-500 ms	50	Defines the time interval between fragments of the response message when it is fragmented

Scaling 16-bit AI objects

Scaling 16-bit AI objects allows accommodating native 32-bit analog input readings to 16-bit object format; otherwise it may cause an over-range error if the full-range value exceeds a 16-bit point limit.

Scaling is enabled by default. It is not related to points that are read using 32-bit AI objects.

Refer to the PM335 PRO DNP3 Reference Guide for information on the data point scales and a reverse conversion that should be applied to the received scaled values.

Scaling 16-bit Binary Counters

Scaling 16-bit Binary Counters allows changing a counter unit in powers of 10 to accommodate a 32-bit counter value to 16-bit BC object format.

If the scaling unit is greater than 1, the counter value is reported being divided by the selected scaling unit from 10 to 1000. To get the actual value, multiply the counter reading by the scaling unit.

Configuring DNP Class 0 Responses

The most common method of getting static object information from the meter via DNP is to issue a read Class 0 request. The PM335 PRO allows you to configure the Class 0 response by assigning ranges of points to be polled via Class 0 requests.

To view or build a DNP Class 0 response message:

1. Select Protocol Setup from the Meter Setup menu and click on the DNP Class 0 Points tab.
2. Select the object and variation type for a point range.
3. Specify the start point index and the number of points in the range. Refer to the PM335 PRO DNP3 Reference Guide for available data points.
4. Repeat these steps for all point ranges you want to be included into the Class 0 response.
5. Click Send to download your setup to the meter.

The factory-set Class 0 point ranges are shown in the picture below.

³ The Select Before Operate command causes the meter to start a timer. The following Operate command must be sent before the specified timeout value expires.

⁴ The meter requests time synchronization by bit 4 in the first octet of the internal indication word being set to 1 when the time interval specified by the Time Sync Period elapses. The master should synchronize the time in the meter by sending the Time and Date object to clear this bit. The meter does not send time synchronization requests if the Time Sync Period is set to 0.

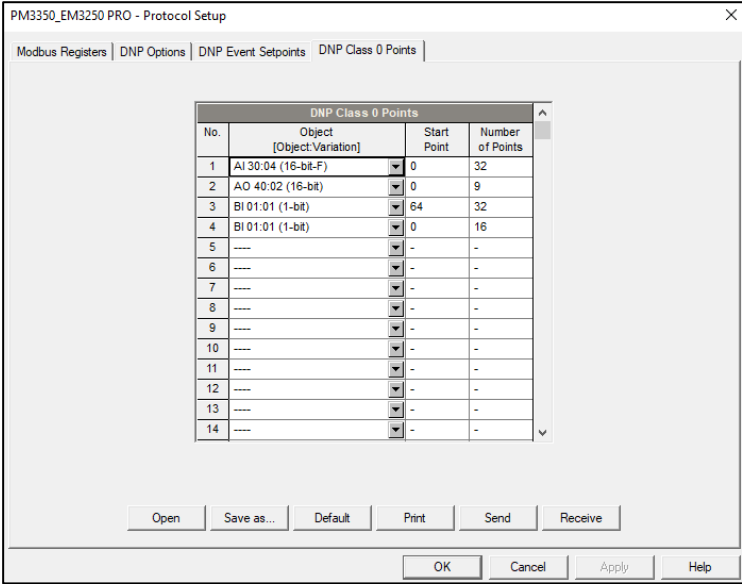

Figure 9-3: Protocol Setup Dialog Box – DNP Class 0 Points Tab

Configuring IEC 60870-5

The EM235/PM335 PRO protocol stack is implemented in a very flexible manner. Most of IEC 60870-5-101/104 protocol features are user-configurable allowing easy adaptation for use in different IEC 60870-5 installations. To keep maximum interoperability with master RTU and SCADA systems, the PM335 PRO supports all standard ASDU types for data interrogation, event reporting and control.

The support PAS configuration software supplied with the meter provides all necessary tools for remote configuration of the meter via serial ports or via a TCP/IP Internet connection using either IEC 60870-5-101/104, or Modbus protocol.

The EM235/PM335 PRO is equipped with two independent Ethernet ports sunning TCP/IP protocol, enabling two independent communication protocols IEC 60870-5-104 to access two different SCADA.

For more information see PM335 PRO IEC 60870-5 communication guide.

Configuring IEC 60870-5 Options

To configure the IEC 60870-5 options:

1. Select IEC 60870-5 Setup from the Meter Setup menu.
2. Select the desired Network (1 or 2)

Figure 9-4: Protocol Setup Dialog Box – IEC 60870-5 Options Tab

3. Select desired options.
4. Click Save as... to store your setup in the device site database, and click Send to send the setup to the device

See the following table for available options.

Parameter	Options	Default	Description
General IEC 60870-5 Options			
Maximum frame length	32-255 octets	255	The maximum length of the transmission frame. In IEC 60870-5-104 it is fixed to 253 octets.
Link address	1-2 octets	1	Link address length
Cause of transmission	1-2 octets	1	Cause of transmission length. In IEC 60870-5-104 it is fixed to 2 octets.

Parameter	Options	Default	Description
Common address of ASDU	1-2 octets	1	Length of common address of ASDU. In IEC 60870-5-104 it is fixed to 2 octets.
Information object address	1-3 octets	2	Length of information object address In IEC 60870-5-104 it is fixed to 3 octets.
SBO Timeout, s	0-30 s	10	Select-before-operate (SBO) timeout for single point commands with a select qualifier
Short pulse duration, ms	100-3000 ms	500	Short pulse duration for single point commands with a short pulse qualifier
Long pulse duration, ms	100-3000 ms	1000	Long pulse duration for single point commands with a long pulse qualifier
Time sync period, s	1-86400 s, 0=not active	0	The time interval between periodic time synchronization requests
Local counter freeze period, min	1-60 min, 0=not active	0	The period of local counter freeze and spontaneous transmission of integrated totals
Respond with class 1 data to class 2	0=disabled, 1=enabled	Disabled	If enabled, the meter will respond with class 1 data to class 2 requests when there is no class 2 data in transmission
IEC 60870-5-104 Options			
Maximum unacknowledged ASDU	1-32, 0=unlimited	12	The maximum number of unacknowledged ASDU allowed before suspending data transmission. Unlimited when set to 0.
Cyclic transmission period, ms	100-30000 ms, 0=not active	0	The period of cyclic/periodic data transmission via the IEC 60870-5-104 port
Redundant connection IP address #1	0.0.0.0 =not active	0.0.0.0	The IP address of the controlling station for all data transmission
Redundant connection IP address #2	0.0.0.0 =not active	0.0.0.0	The IP address of the redundant controlling station for all data transmission

Parameter	Options	Default	Description
IEC 60870-5-104 IP Redundancy Mode	1 or 2	1	1 - Standard IP Redundancy Mode (Two logical connections between the controlled station and the same controlling station, both logical connections should be open in order to transmit data) 2 - Enhanced IP Redundancy Mode (Two logical connections between the controlled station and 2 different controlling stations, Cyclic/Periodic data can be transmitted on a specific connection even if it is the only open connection)
IEC 60870-5 Information Objects			
Measured value mapped address	1-4095	1	Starting address for mapped static measured value objects
Measured value default type	M_ME_NA_1 M_ME_NB_1 M_ME_NC_1 M_ME_TA_1 M_ME_TB_1 M_ME_TC_1 M_ME_TD_1 M_ME_TE_1 M_ME_TF_1	M_ME_NB_1	The default type of static measured value objects for Read requests
Measured value event type	M_ME_TA_1 M_ME_TB_1 M_ME_TC_1 M_ME_TD_1 M_ME_TE_1 M_ME_TF_1	M_ME_TE_1	The default type of measured value objects for event reporting
Single point mapped address	1-4095	101	Starting address for mapped static single point objects
Single point default type	M_SP_NA_1 M_SP_TA_1 M_SP_TB_1	M_SP_NA_1	The default type of static single point objects for Read requests
Single point event type	M_SP_TA_1 M_SP_TB_1	M_SP_TB_1	The default type of single point objects for event reporting
Double point mapped address	1-4095	201	Starting address for mapped static double point objects
Double point default type	M_DP_NA_1 M_DP_TA_1 M_DP_TB_1	M_DP_NA_1	The default type of static double point objects for Read requests
Double point event type	M_DP_TA_1 M_DP_TB_1	M_DP_TB_1	The default type of double point objects for event reporting
Integrated totals mapped address	1-4095	301	Starting address for mapped static integrated totals objects
Integrated totals default type	M_IT_NA_1 M_IT_TA_1 M_IT_TB_1	M_IT_NA_1	The default type of static integrated totals for Read requests
Integrated totals event type	M_IT_TA_1 M_IT_TB_1	M_IT_TB_1	The default type of integrated totals for event reporting

Parameter	Options	Default	Description
Measurement Units			
Voltage units	0=V, 1=kV	V	Units of voltage measured values
Current units	0=A, 1=kA	A	Units of current measured values
Power units	0=kW, 1=MW	kW	Units of power measured values

NOTES:

- In IEC 60870-5-104 the maximum length of the variable frame, the common address of ASDU, information object address and cause of transmission length are permanently set to values indicated in the table and the optional settings are ignored.
- Selecting the one-octet information object address length for IEC 60870-5-101 will limit the range of objects to only mapped points in the range of 1 to 255 and will make impossible configuring IEC 60870-5 in the device via IEC 60870-5-101 ports.

Remapping Point Addresses and Event Reporting

NOTE:

The process measurement scales for most analog values depend on your external PT and CT settings and on the voltage and current scales defined in the meter. Configure them in your meter and save to the device site database before configuring event deadbands. See Basic Setup and Device Options Setup in the EM133 Installation and Operation Manual on how to configure these parameters in the meter.

To remap static object point addresses to the configurable address space and to configure corresponding event objects:

- Select IEC 60870-5 Setup from the Meter Setup menu, and then click on the IEC 60870-5 Mapped Points and Events Setup tab.
- Select the desired Network (1 or 2)

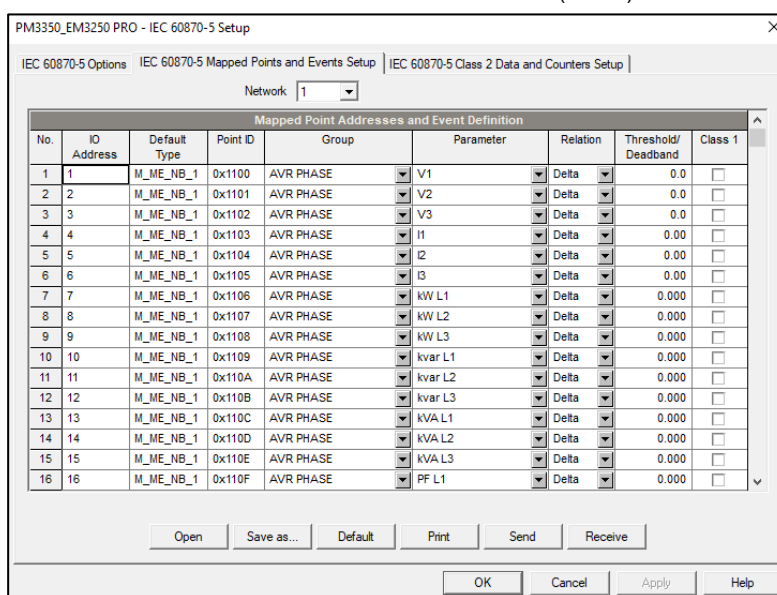

Figure 9-5: Protocol Setup Dialog Box – IEC 60870-5 Mapped Points and Events Setup Tab

- Select an object group and parameter for points you wish to remap. Object types and addresses are assigned automatically upon the starting mapped address and default static type you selected for the type of objects in the IEC 60870-5 Options Setup. When saving the

setup to the device database or sending to the meter all points are automatically arranged in the order: measured values, single point objects, double point objects, integrated totals.

4. If you wish to use a static point for reporting events, select a relation and an operating threshold or a deadband to be used for detecting events and check the Class 1 box for the point. The following options are available:
 - Delta – a new event is reported when the absolute value of the difference between the last reported point value and its current value exceeds the specified deadband value, or the status of a binary point changes. Measured values with a zero deadband will not be checked for events;
 - More than (over) - a new event is reported when the point value rises over the specified threshold, and then when it returns below the threshold minus a predefined return hysteresis – applicable for measured values;
 - Less than (under) - a new event is reported when the point value drops below the specified threshold, and then when it returns above the threshold plus a predefined return hysteresis – applicable for measured values.

Hysteresis of the return threshold for measured values is 0.05 Hz for frequency and 2% of the operating threshold for other points.

All thresholds/deadbands for measured values should be specified in primary units.

5. Click Save as... to store your setup in the device site database, and click Send to send the setup to the device.

Configuring Class 2 Data and Counter Transmission

This setup allows you to configure object address ranges for interrogation, cyclic/periodic data transmission, and spontaneous counter transmission with or without local freeze/reset.

To configure object address ranges for data transmission:

1. Select IEC 60870-5 Setup from the Meter Setup menu, and then click on the IEC 60870-5 Class 2 Data and Counters Setup tab.
2. Select the desired Network (1 or 2)

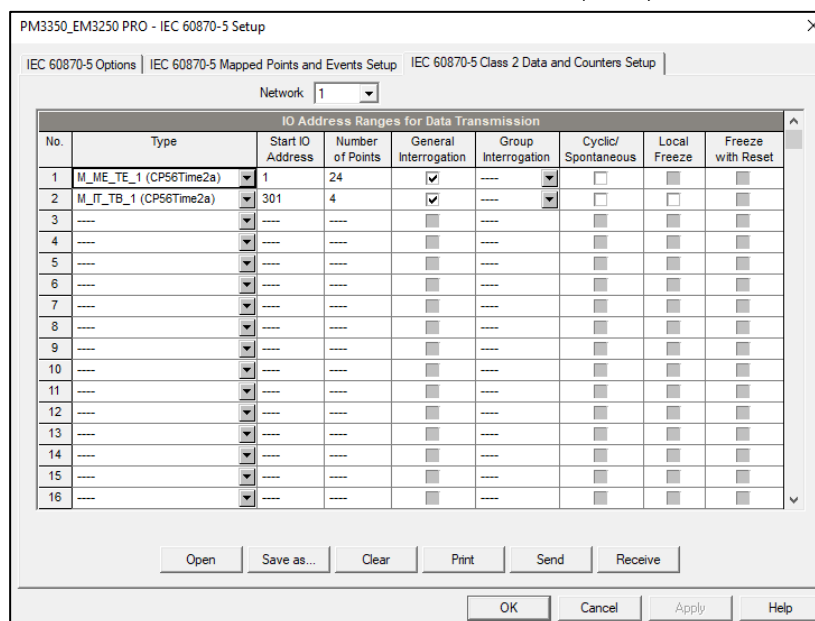

Figure 9-6: Protocol Setup Dialog Box – IEC 60870-5 Class 2 Data and Counters Setup Tab

3. Select object type and specify ranges of points to be included into interrogation responses or/and cyclic/spontaneous data transmission. Only mapped point addresses and general object addresses can be used for interrogation and cyclic/spontaneous transmission

Up to 32 address ranges can be selected. Fill rows in succession without gaps. The first blank row will be taken as the end of a range list.

NOTE:

Though double point objects occupy two adjacent addresses, always specify the actual number of requested double points as you define other object ranges.

Class 2 interrogated and cyclic/spontaneous data are always transmitted in the order they are listed in the setup. If you put ranges of point of the same type at continuous rows, they will be packed together and transmitted using minimum number of frames.

1. Check the "General Interrog" box for ranges you wish to include into the general/station interrogation.
2. Select appropriate groups in the "Group Interrog" box for ranges you wish to include into group interrogation. Each range of points can be allocated for both global and group interrogation.
3. Check the "Cyclic/Spont." box for ranges you wish to include into cyclic/spontaneous data transmission.

Analog and binary data checked for cyclic transmission will be transmitted as cyclic messages. The IEC 60870-5-104 cyclic data transmission period is configurable via the IEC 60870-5 Options setup.

Integrated totals checked for spontaneous transmission will be transmitted as spontaneous messages at configurable local counter freeze/transmission intervals.

4. Check the "Local Freeze" box for A and B modes of transmission of integrated totals with local freeze.

NOTE:

Counters checked for spontaneous transmission without local freeze will be periodically reported at specified counter freeze/transmission intervals either with the frozen counter values if a remote freeze command was issued for counters before (mode D of acquisition of integrated totals), or with the actual counter values for counters that were not frozen.

1. Check the "Freeze with Reset" box for integrated totals for which local freeze with reset should be applied.
2. Click Save as... to store your setup in the device site database, and click Send to send the setup to the device.

Configuring IEC 61850

The PAS software supplied with the PMX3X/EM235 PRO provides a configuration tool for customizing your device and generating a configured IED description (CID) file for use with IEC 61850 client applications.

To reset the IEC 61850 settings to the factory defaults:

1. Select Administration->Master Reset from the Monitor menu.
2. Click the "Reset IEC 61850 Configuration" button, and then confirm the command.

Licensing IEC 61850

A valid license key must be provided in the PMX3X/EM235 PRO for IEC 61850 communications. The device is normally shipped with a temporary license, which is valid for a 30-day operation and then can be extended for an additional month.

A permanent license can be obtained from your local distributor for an additional fee. A device serial number must be provided in the license request. The device may also be shipped with the permanent license in the event of a pre-paid fee.

To program a license key in you device:

1. Select Administration->Update License from the Monitor menu.

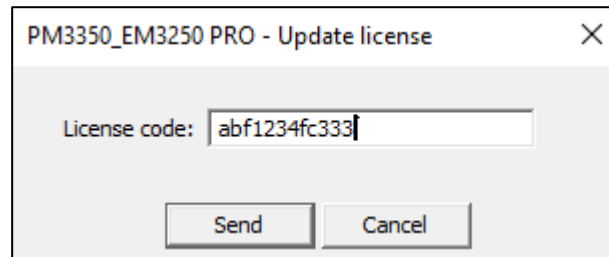

2. Type in the license code and click Send.

Configuring IED Properties

The IEC 61850 configurator allows you to configure the IED name, device location, measurement units and communication options, and to arrange a set of report control blocks for multi-client installations

To configure the IED properties in your device:

1. Select IEC 61850 Setup from the Meter Setup menu, and then click on the IEC 61850 IED Properties tab.
2. Configure IED options for your application as required.

NOTES

- The configured IED name accompanies logical device names in object references.
- The device location also identifies the substation location in COMTRADE configuration files as the station_name attribute.
- Attributes marked with the asterisk cannot be changed in the device via this setup but you can define and store them to the device database when working offline to use for updating a device CID file.
- The number of RCB instances defines how pre-defined RCBs are arranged in the device for use in multi-client applications. The RCBs are automatically pre-configured in the device in the way indicated in Section “Reporting model”. The RCB names and report IDs are set to defaults as the number of RCB instances changes. If you intend to change the default setting, set it first before configuring report control blocks.

3. Send your setup to the device and save it to the device database.

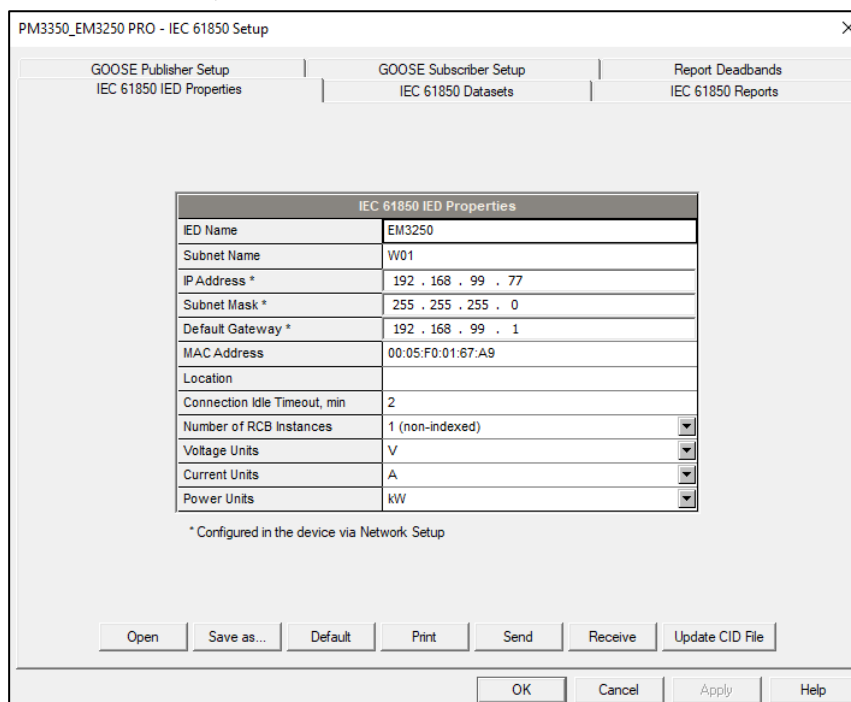

Figure 9-7: Protocol Setup Dialog Box – IEC 61850 IED Properties Setup Tab

Configuring Datasets

To review or configure the IEC 61850 datasets:

1. Select IEC 61850 Setup from the Meter Setup menu, and then click on the IEC 61850 Datasets tab.
2. Select a dataset you wish to view or configure in the “Dataset Reference” box. Select “New Dataset” to create a new dataset.
3. To delete dataset members, uncheck the appropriate “Included” boxes. Uncheck all dataset members to delete the entire dataset.
4. To add or change dataset members, click “Edit from file”, locate the PM335_EM235.icd template file or a CID file you generated for your device, and click Open.

A full list of the available data objects and data attributed is displayed, where included dataset members are checked.

To create a new dataset, select a logical device where the dataset will be located and type a dataset name in the “Dataset Name” box.

Check the “Included” boxes for items you wish to be members of the dataset and click OK.

To make easy selection of items across the list, use filters - functional constraints or/and a selected logical device/logical node. Click “Filter checked” to see and revise a list of the selected items.

5. Send your new setup to the device and save it to the device database.

PM3350_EM3250 PRO - IEC 61850 Setup

GOOSE Publisher Setup | GOOSE Subscriber Setup | Report Deadbands
IEC 61850 IED Properties | IEC 61850 Datasets | IEC 61850 Reports

Dataset Items: 19 Selected Items: 19 Check/Uncheck All

Deletable/Changeable Datasets

Dataset Reference: CTRL/LLN0\$PM3350_EM3250

No.	Member Reference	Included
1	MET1/LLN0\$ST\$Mod	<input checked="" type="checkbox"/>
2	MET1/LLN0\$ST\$Mod\$StVal	<input checked="" type="checkbox"/>
3	MET1/LLN0\$ST\$Mod\$Sq	<input checked="" type="checkbox"/>
4	MET1/LLN0\$ST\$Mod\$St	<input checked="" type="checkbox"/>
5	MET1/LLN0\$ST\$Beh	<input checked="" type="checkbox"/>
6	MET1/LLN0\$ST\$Beh\$StVal	<input checked="" type="checkbox"/>
7	MET1/LLN0\$ST\$Beh\$Sq	<input checked="" type="checkbox"/>
8	MET1/LLN0\$ST\$Beh\$St	<input checked="" type="checkbox"/>
9	MET1/LLN0\$ST\$Health	<input checked="" type="checkbox"/>
10	MET1/LLN0\$ST\$Health\$StVal	<input checked="" type="checkbox"/>
11	MET1/LLN0\$ST\$Health\$Sq	<input checked="" type="checkbox"/>
12	MET1/LLN0\$ST\$Health\$St	<input checked="" type="checkbox"/>
13	MET1/LPHD1\$ST\$PhyHealth	<input checked="" type="checkbox"/>
14	MET1/osvMMXU1\$MX\$PhV\$phsA\$ScVal	<input checked="" type="checkbox"/>

Open Save as... Default Print Send Receive Edit from File Update CID File

OK Cancel Apply Help

Configuring Report Control Blocks

To configure Report Control Blocks in your device:

1. Select IEC 61850 Setup from the Meter Setup menu, and then click on the IEC 61850 Reports tab.

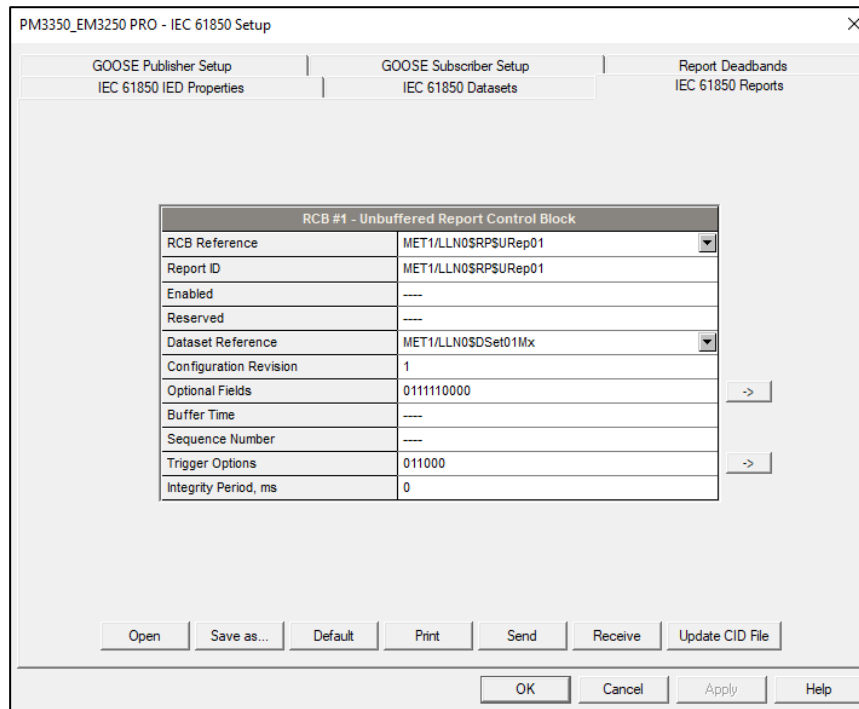

2. Select an RCB you wish to view or configure in the “RCB Reference” box.
3. Configure the RCB attributes as required for your application. The following items can be configured:
 - Report ID
 - Dataset reference (can be selected from the available datasets list)
 - Optional fields
 - Trigger options
 - Integrity period for periodic reports with the integrity trigger option selected

To change the Optional fields or Trigger options, click the arrow button at the right to the item, check the appropriate options and click OK.

NOTE

Configure your new and customized datasets and update them in the device, or save to the device database if you work offline, before configuring reports; otherwise you may get an incomplete dataset list.

4. Send your new setup to the device and save it to the device database.

Configuring the GOOSE Publisher

The PMX3X/EM235 PRO GOOSE publisher provides the dedicated dataset CTRL/LLN0\$DSetGOOSE1 for GOOSE communications. The default dataset variables list can be modified via the IEC 61850 Datasets setup (see Section 6.3).

To configure the GOOSE publisher:

1. Select IEC 61850 Setup from the Meter Setup menu, and then click on the GOOSE Publisher Setup tab.
2. Configure the destination MAC address, application ID and the maximum message retransmission interval as required for your application. Other setup attributes are not changeable and are indicated for information only.
3. Select Yes in the Publisher Enabled box to enable publisher operation.
4. Send your setup to the device.

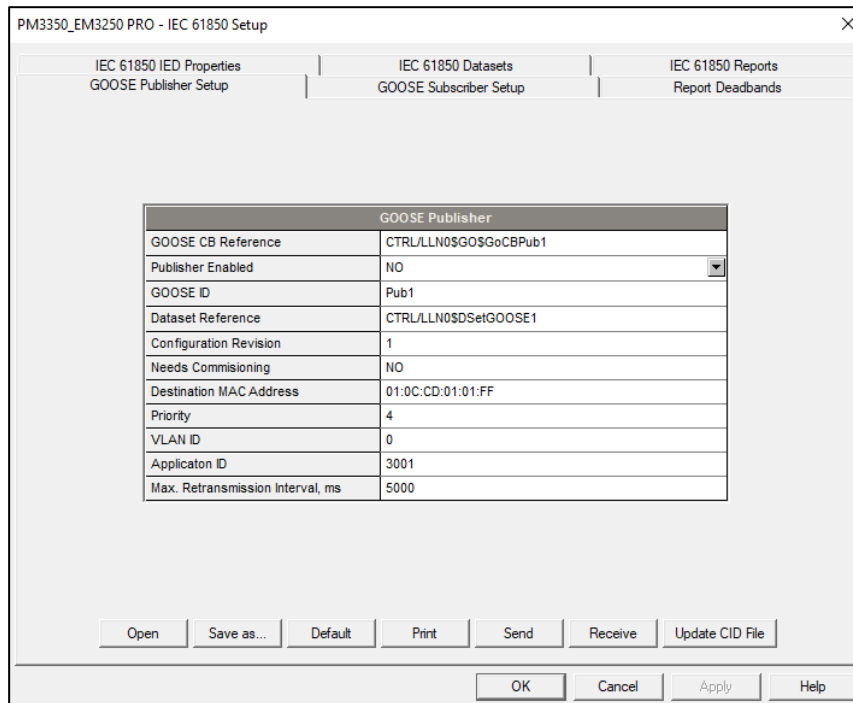

Configuring the GOOSE Subscriber

The PMX3X/EM235 PRO can be subscribed to messages sent by any GOOSE network device including both PMX3X/EM235 PRO and non-SATEC devices.

The GOOSE subscriber supports up to 20 subscriptions with up to 16 data elements in each subscription. The location of the subscribed elements in GOOSE data sets and mapping to the PMX3X/EM235 PRO internal variables are configurable. The subscription elements are selected from a publishing device's ICD/CID file.

The PMX3X/EM235 PRO provides a set of internal variables for mapping external GOOSE data:

- a 128-bit binary string composed of 128 binary variables ExtInd1...ExtInd128 of type BOOLEAN called external indication and intended for mapping single-point BOOLEAN and integer elements and double-point Dbpos data;
- 32 variables ExtiVal1...ExtiVal32 of type INT32 for mapping signed and unsigned integer numbers of any size;
- 32 variables ExtfVal1...ExtfVal32 of type FLOAT32 for mapping single-precision floating point numbers.

When the subscriber receives GOOSE message updates, the subscribed data is copied to the internal variables that can be monitored and recorded in the device like any other measured value. When the subscriber does not receive updates, or the declared message live time has expired, or the data set differs from the subscriber setup, the internal variables are zeroed and the non-active status is indicated in the subscription status.

The subscription status can be monitored from an IEC 61850 client via the GOOSE subscriber logical nodes CTRL/sbsLGOS1-CTRL/sbsLGOS20, or from a Modbus client application via the GOOSE subscriber status register (see the PMX3X/EM235 PRO Modbus Reference Guide for the register location).

To configure the GOOSE subscriber:

1. Select IEC 61850 Setup from the Meter Setup menu, and then click on the GOOSE Subscriber Setup tab.

PM3350_EM3250 PRO - IEC 61850 Setup

IEC 61850 IED Properties | IEC 61850 Datasets | IEC 61850 Reports
GOOSE Publisher Setup | GOOSE Subscriber Setup | Report Deadbands

GOOSE Subscriber Settings

Subscription Number	1
Subscription Enabled	NO
Dataset Reference	
Configuration Revision	1
Destination MAC Address	01:0C:CD:01:01:01
Application ID	3001

Mapped GOOSE Message

No.	Element No.	Member Reference	Type	Input Variable
1	---		---	---
2	---		---	---
3	---		---	---
4	---		---	---
5	---		---	---
6	---		---	---
7	---		---	---
8	---		---	---
9	---		---	---
10	---		---	---
11	---		---	---
12	---		---	---

Open Save as... Default Print Send Receive Open SCL File

OK Cancel Apply Help

- In the Subscription Number box, select the subscription you wish to configure.
- Click the “Open SCL File” button and open an ICD or CID file for the publishing device you wish to subscribe to. PAS shows you a list of all datasets linked to GOOSE publisher control blocks that are found in the ICD/CID file. Check the Subscribe box for the dataset you wish to subscribe to.

PM33xx PRO REV2.icd - [C:\Working folder\PRO\COMM guide]

Published Datasets

No.	IED Name	Dataset Reference	Subscribe
1	TEMPLATE	TEMPLATECTRL/LLN0.DSetGOOSE1	<input type="checkbox"/>
2	----	----	<input type="checkbox"/>
3	----	----	<input type="checkbox"/>
4	----	----	<input type="checkbox"/>
5	----	----	<input type="checkbox"/>
6	----	----	<input type="checkbox"/>
7	----	----	<input type="checkbox"/>
8	----	----	<input type="checkbox"/>
9	----	----	<input type="checkbox"/>
10	----	----	<input type="checkbox"/>
11	----	----	<input type="checkbox"/>
12	----	----	<input type="checkbox"/>

OK Cancel

- The publisher attributes and a list of dataset members for the selected dataset are displayed as shown in the picture below. PAS also indicates a basic IEC 61850 data element type and a physical MMS type for dataset members. Check the Subscribe boxes for elements you want to subscribe to, and then click OK.

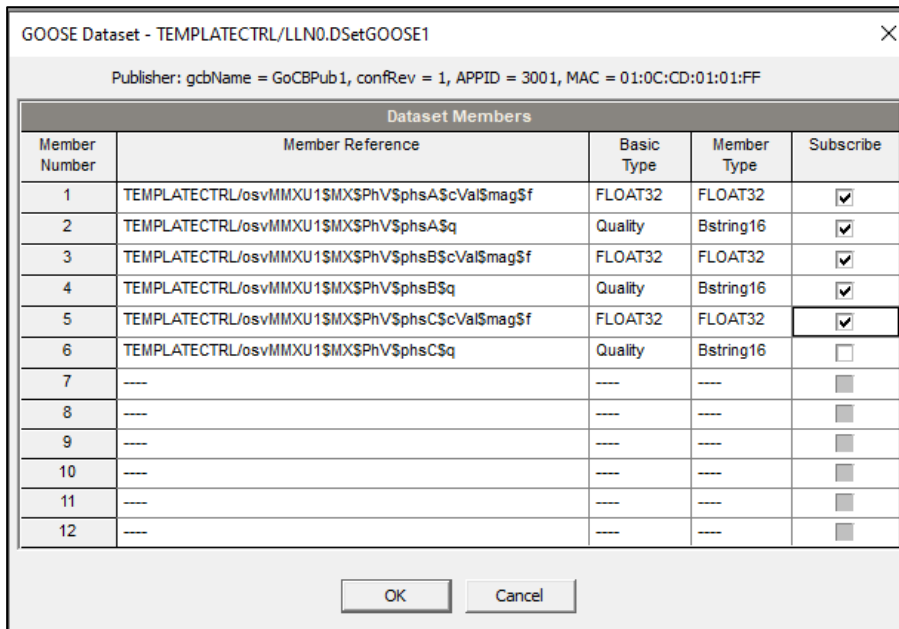

You are allowed to select no more than 16 elements. Elements with incompatible data types are not allowed for selection.

The publisher attributes of the selected dataset and the selected data elements are copied to the current subscription.

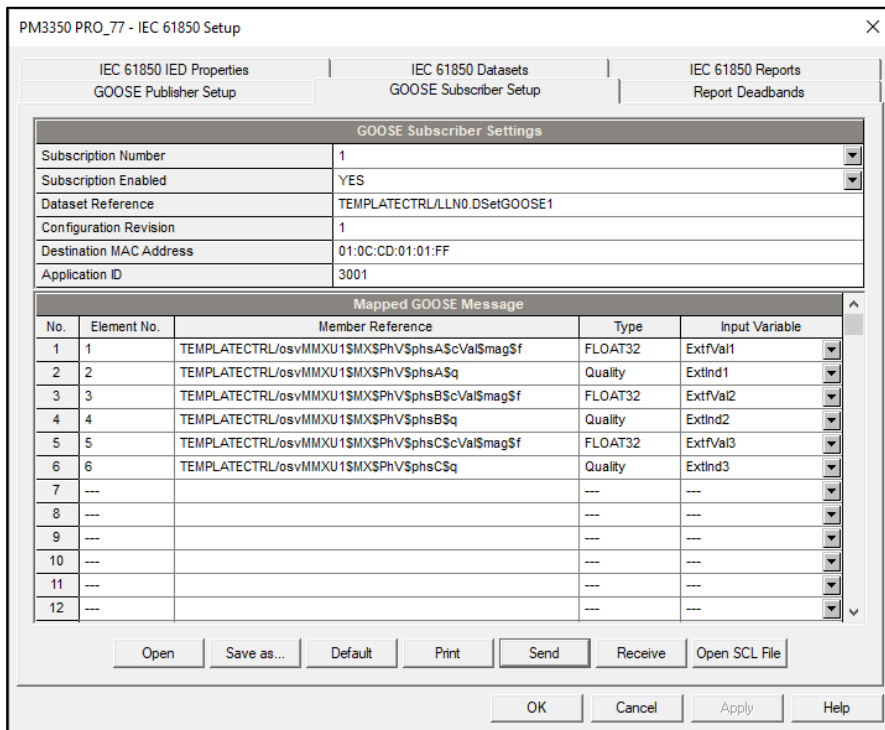

Select compatible input variables to which dataset elements will be mapped in the device. See the table below for allowable mapping options depending on the basic variable type.

Basic Data Type	MMS Data Type	Compatible Input Variables
BitString32	Bstring32	ExtInd, ExtiVal
Dbpos	Bstring8	ExtInd, ExtiVal
Enum	INT8	ExtInd, ExtiVal
INT32	INT32	ExtInd, ExtiVal

Basic Data Type	MMS Data Type	Compatible Input Variables
INT32U	INT32U	ExtIInd, ExtiVal
INT16	INT16	ExtIInd, ExtiVal
INT16U	INT16U	ExtIInd, ExtiVal
INT8	INT8	ExtIInd, ExtiVal
INT8U	INT8U	ExtIInd, ExtiVal
BOOLEAN	BOOLEAN	ExtIInd, ExtiVal
FLOAT32	FLOAT32	ExtfVal

NOTES:

- Mapping integer data to a BOOLEAN ExtIInd variable results in copying a least-significant bit of the dataset member only.
 - Mapping double-point data of type Dbpos to a BOOLEAN ExtIInd variable causes a high-order bit of the dataset member to be copied to the following BOOLEAN ExtIInd variable.
5. Check the application ID, configuration revision and destination MAC address to meet the GOOSE publisher attributes.
 6. Select Yes in the Subscription Enabled box to activate the subscription.
 7. Repeat the setup for other subscriptions you wish to configure, and then send your setup to the device and save to the device database. Notice that dataset member names are not stored in the device and will not be displayed when reading the setup from the device unless you saved the setup in the device database on your PC.

Note: GOOSE notification is available only from the ETH1 interface

Chapter 10 Device Control

This chapter describes how to change device modes, view and clear device diagnostics, and directly operate relay outputs in your PM335 PRO from PAS. To access device control options you should have your device online.

Authorization

If your device is password protected you are prompted for the password when you send your first command to the device.

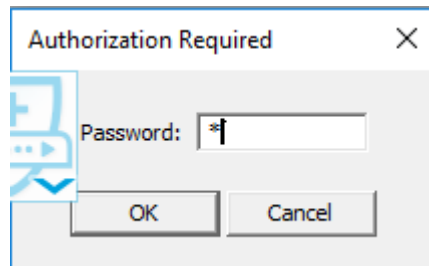

Enter the password and click OK. If your authorization was successful, you are not prompted for the password again until you close the dialog window.

Remote Relay Control

From PAS, you can send a command to any relay in your device or release a latched relay, except of the relays that are linked to the internal pulse source. Such relays cannot be operated outside of the device.

To enter the Remote Relay Control dialog, check the On-line  button on the PAS toolbar, select Device Control from the Monitor menu, and then click on the Remote Relay Control tab.

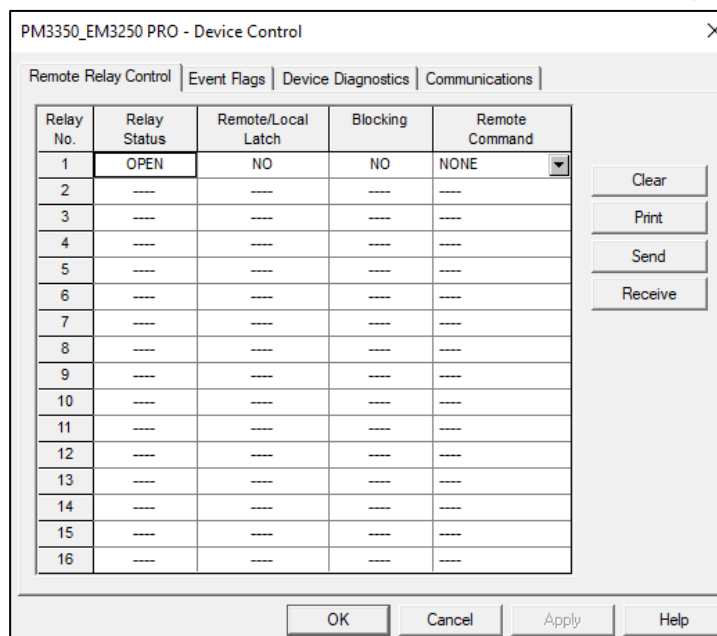

Figure 10-1: Device Control Box – Remote Relay Control Tab

To send a remote command to the relay:

1. From the “Remote Relay Control” box for the relay, select the desired command.
2. Click on Send.

The dialog shows you the present relay status and whether it is latched by a remote command or locally from the setpoints.

Device Event Flags

The PM335 PRO has 64 common event flags that are intended for use as temporary event storage and can be tested and operated from the control setpoints. You can transfer an event to the setpoints and trigger its operation remotely by changing the event status through PAS.

To enter the Event Flags dialog, check the On-line button on the PAS toolbar, select Device Control from the Monitor menu, and then click on the Event Flags tab.

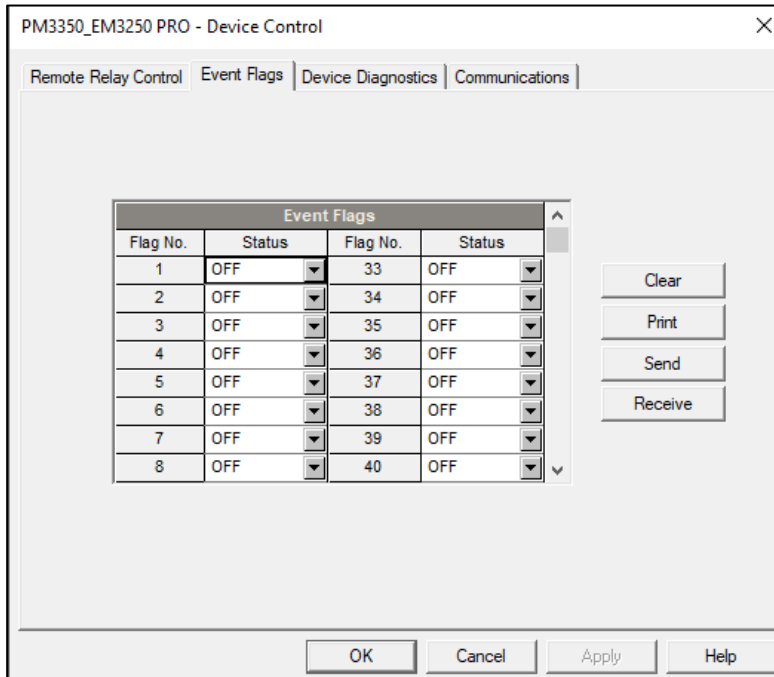



Figure 10-2: Device Control Box – Event Flags Tab

To change the status of an event flag:

1. From the "Status" box for the event flag, select the desired flag status.
2. Click on Send.

Viewing and Clearing Device Diagnostics

You can examine the present device diagnostics status and clear it via PAS.

To enter the Device Diagnostics dialog, check the On-line  button on the PAS toolbar, select Device Control from the Monitor menu, and then click on the Device Diagnostics tab.

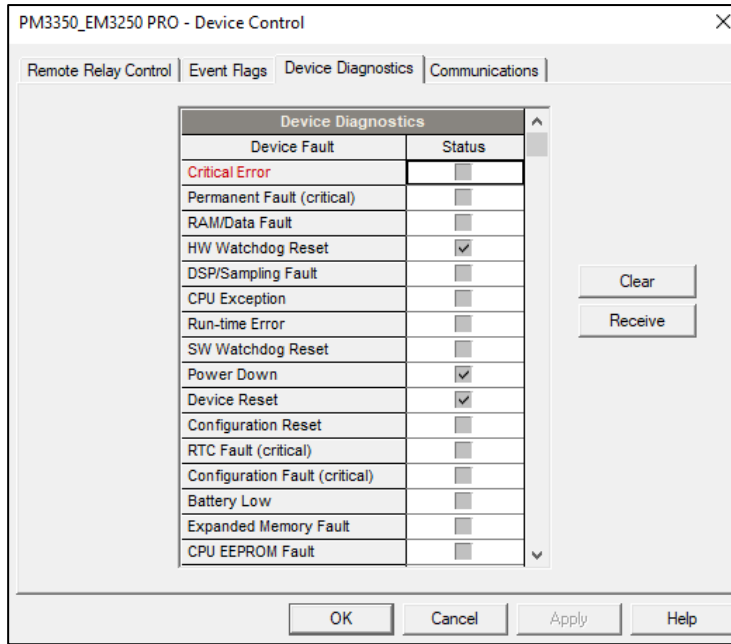

Figure 10-3: Device Control Box – Event Flags Tab

To clear the device diagnostics events, click on Clear.

Refer to [Device Diagnostic Codes](#) in Appendix F for the list of diagnostic codes and their meanings. See [Device Diagnostics](#) in Chapter 3 for more information about device diagnostics.

Viewing Communication Status and Statistics

Ensure that the On-line button on the PAS toolbar is checked, select Device Control from the Monitor menu, and then click on the Communications tab.

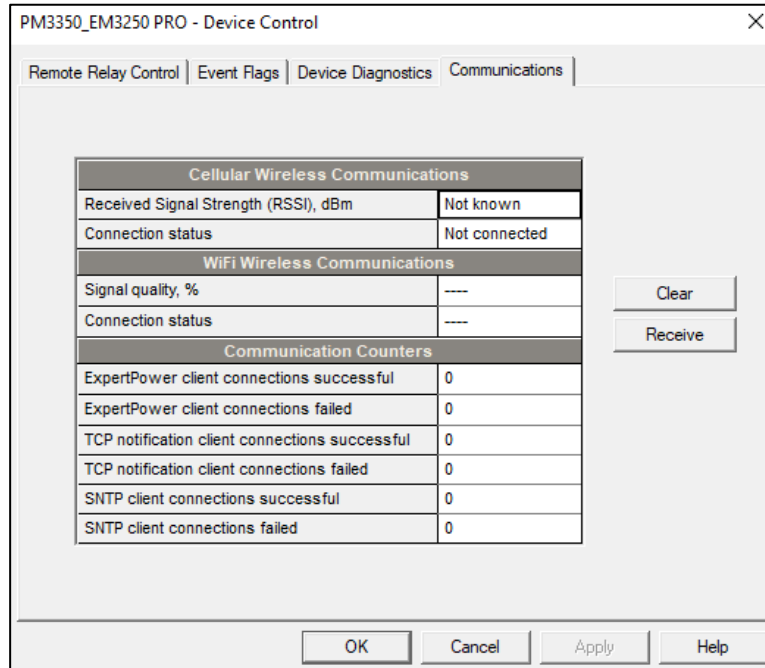

Figure 10-4: Device Control Dialog Box – Communications Tab

This window indicates the present GPRS communication status (see [Setting Up GPRS Network](#) in Chapter 5) and connection statistics of the TCP clients (see [Setting Up eXpertPower Client](#) and [Setting Up TCP Notification Client](#) in Chapter 5).

To clear the communication counters, click on Clear.

You can also clear the communications counters via the PAS Reset dialog (see [Resetting Accumulators, Maximum Values and Files](#)).

Resetting Accumulators and Clearing Log Files

This section describes how to reset accumulators and demand registers and log files (data log and waveform log).

Using the Front Display

Reset maximum demands

Access Reset Setup menu, Select MAX DMD and clear the desired maximum demands as described below using UP/DOWN navigation buttons and OK/ENTER button.

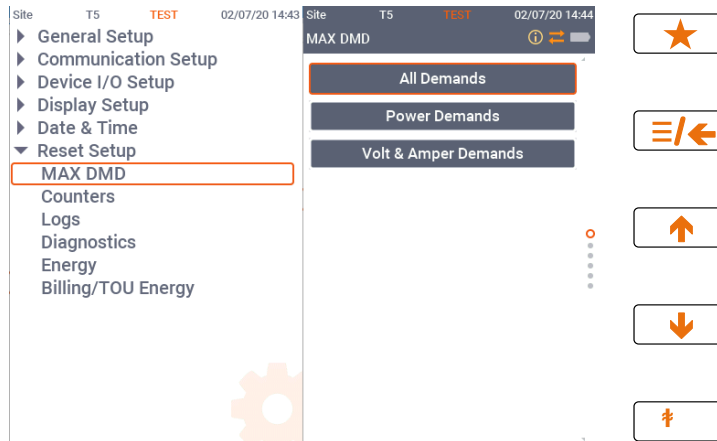

Note:

The EM235 display menus is identical to the PM335 display menus

Reset Counters

Access Reset Setup menu, Select Counters and clear the desired counters as described below using UP/DOWN navigation buttons and OK/ENTER button.

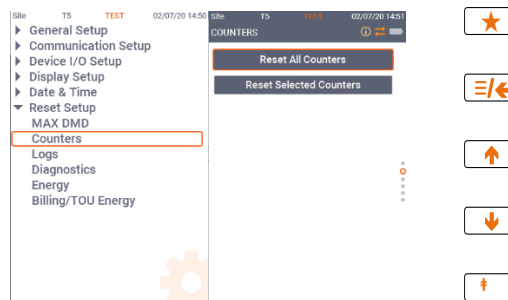

Note:

The EM235 display menus is identical to the PM335 display menus

Reset Logs

Access Reset Setup menu, Select Logs and clear the desired logs as described below using UP/DOWN navigation buttons and OK/ENTER button.

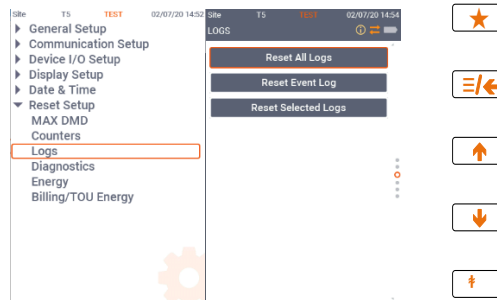

Note:

The EM235 display menus is identical to the PM335 display menus

Using PAS

PAS allows you to clear energy accumulators, maximum demands, Min/Max log registers, counters and log files in your device. To open the Reset dialog, select a device site from the list box on the toolbar, check the On-line button  on the toolbar, and then select Reset from the Monitor menu.

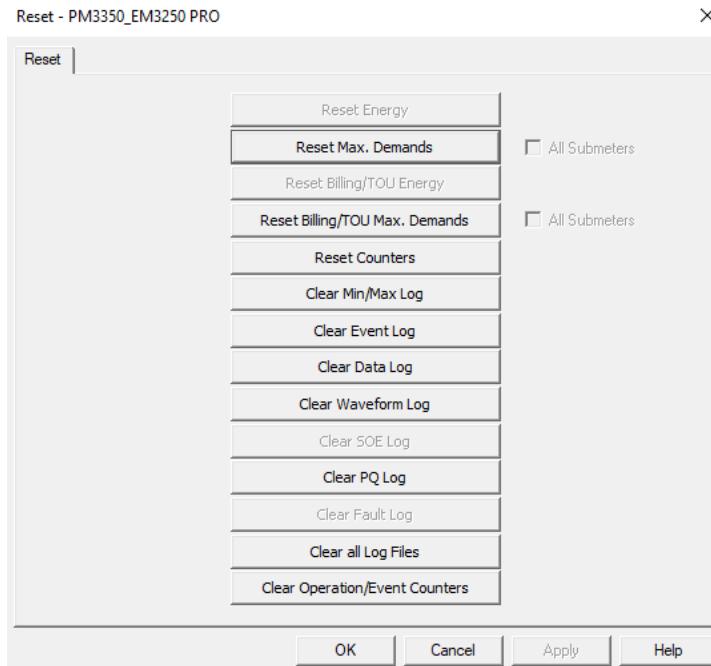

Figure 10-5: Monitor Box – Reset Tab

To reset the desired accumulation registers or to clear a file, click on the corresponding button. If a target has more than one component, you are allowed to select components to reset. Check the corresponding boxes, and then click OK.

This section describes operations on the meter you can perform from the front display or via PAS. To access device control options from PAS, you should have your meter online.

To reset the desired values or files:

1. Click on the corresponding button, and then confirm your command.
4. If an entry has more than one target, you are allowed to select targets to reset.
5. Check the corresponding boxes, and then click OK.

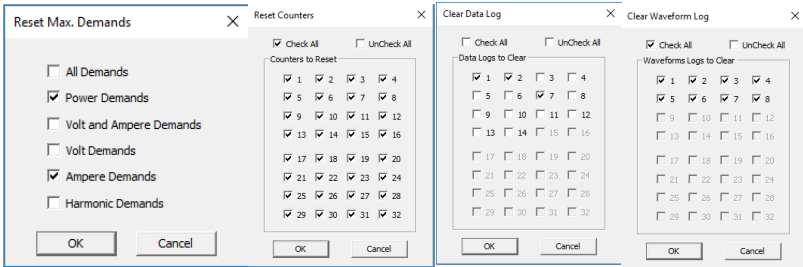

Figure 10-6: Multi Targets Reset Dialog Box

Chapter 11 Monitoring Meters

Viewing Real-time Data

Real-time data is continuously retrieved from your devices and updated on the screen at the rate you defined in the Instrument Setup.

To get real-time data from your device, select the device site from the list box on the PAS toolbar, point to RT Data Monitor on the Monitor menu, and then select a data set you want to view.

Organizing Data Sets

PAS supports 33 programmable data sets with up to 40 data parameters. Set #0 is intended for simple meters, which have a limited number of parameters, and is not recommended for the use with the EM235/PM335 PRO. To re-organize data sets, select Data Set from the Monitor menu or click on the

button  on the local toolbar. Real-time data can be continuously retrieved from your devices and updated on the screen at the rate you defined in the Instrument Setup.

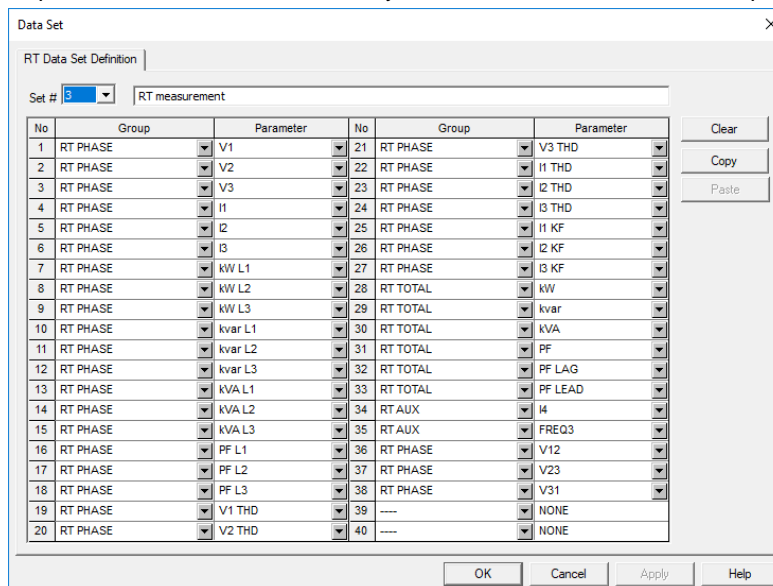





Figure 11-1: RT Measurement Data Set definition

Some data sets are preset for your convenience and others are empty. You can freely modify data sets.

Polling Devices

To run data polling, check the On-line button  on the PAS toolbar, and then click on either the Poll button  or Continuous Poll button  on the local toolbar. Click on the Stop button  to stop continuous polling,

You can open as many data monitor windows as you wish, either for different sites, or for the same site using different data sets.

An open data monitor window is linked to the current site and does not change if you select another site in the site list.

You can view acquired data in a tabular form or in a graphical form as a data trend.

The following picture shows a typical data monitor window.

No.	Date/Time	V1	V2	V3	I1	I2	I3	kW L1	kW L2	kW L3	kvar L1	kvar L2	kvar L3	kVA L1	kVA L2	kVA L3	PF L1
1	25-11-19 12:52:50	233.6	233.6	233.3	0.00	0.00	0.00	0.000	0.000	0.000	0.000	0.000	0.000	0.000	0.000	0.000	0.000
2	25-11-19 12:52:50	233.4	233.4	233.2	0.00	0.00	0.00	0.000	0.000	0.000	0.000	0.000	0.000	0.000	0.000	0.000	0.000
3	25-11-19 12:52:51	233.4	233.4	233.1	0.00	0.00	0.00	0.000	0.000	0.000	0.000	0.000	0.000	0.000	0.000	0.000	0.000
4	25-11-19 12:52:52	233.4	233.5	233.2	0.00	0.00	0.00	0.000	0.000	0.000	0.000	0.000	0.000	0.000	0.000	0.000	0.000
5	25-11-19 12:52:53	233.5	233.5	233.3	0.00	0.00	0.00	0.000	0.000	0.000	0.000	0.000	0.000	0.000	0.000	0.000	0.000
6	25-11-19 12:52:54	233.1	233.0	232.8	0.00	0.00	0.00	0.000	0.000	0.000	0.000	0.000	0.000	0.000	0.000	0.000	0.000
7	25-11-19 12:52:55	233.0	233.0	232.7	0.00	0.00	0.00	0.000	0.000	0.000	0.000	0.000	0.000	0.000	0.000	0.000	0.000
8	25-11-19 12:52:57	233.0	232.9	232.7	0.00	0.00	0.00	0.000	0.000	0.000	0.000	0.000	0.000	0.000	0.000	0.000	0.000
9	25-11-19 12:52:57	233.2	233.1	232.9	0.00	0.00	0.00	0.000	0.000	0.000	0.000	0.000	0.000	0.000	0.000	0.000	0.000
10	25-11-19 12:52:58	233.1	233.0	232.9	0.00	0.00	0.00	0.000	0.000	0.000	0.000	0.000	0.000	0.000	0.000	0.000	0.000
11	25-11-19 12:53:00	232.9	232.9	232.8	0.00	0.00	0.00	0.000	0.000	0.000	0.000	0.000	0.000	0.000	0.000	0.000	0.000
12	25-11-19 12:53:00	233.1	233.1	232.9	0.00	0.00	0.00	0.000	0.000	0.000	0.000	0.000	0.000	0.000	0.000	0.000	0.000
13	25-11-19 12:53:01	233.2	233.2	233.0	0.00	0.00	0.00	0.000	0.000	0.000	0.000	0.000	0.000	0.000	0.000	0.000	0.000
14	25-11-19 12:53:02	233.0	233.0	232.8	0.00	0.00	0.00	0.000	0.000	0.000	0.000	0.000	0.000	0.000	0.000	0.000	0.000
15	25-11-19 12:53:03	233.1	233.1	232.8	0.00	0.00	0.00	0.000	0.000	0.000	0.000	0.000	0.000	0.000	0.000	0.000	0.000
16	25-11-19 12:53:04	233.2	233.1	232.9	0.00	0.00	0.00	0.000	0.000	0.000	0.000	0.000	0.000	0.000	0.000	0.000	0.000
17	25-11-19 12:53:05	232.9	232.9	232.7	0.00	0.00	0.00	0.000	0.000	0.000	0.000	0.000	0.000	0.000	0.000	0.000	0.000
18	25-11-19 12:53:06	233.0	233.0	232.7	0.00	0.00	0.00	0.000	0.000	0.000	0.000	0.000	0.000	0.000	0.000	0.000	0.000
19	25-11-19 12:53:07	233.0	233.0	232.8	0.00	0.00	0.00	0.000	0.000	0.000	0.000	0.000	0.000	0.000	0.000	0.000	0.000
20	25-11-19 12:53:08	233.2	233.2	232.9	0.00	0.00	0.00	0.000	0.000	0.000	0.000	0.000	0.000	0.000	0.000	0.000	0.000
21	25-11-19 12:53:09	233.3	233.3	233.1	0.00	0.00	0.00	0.000	0.000	0.000	0.000	0.000	0.000	0.000	0.000	0.000	0.000
22	25-11-19 12:53:10	233.2	233.1	233.0	0.00	0.00	0.00	0.000	0.000	0.000	0.000	0.000	0.000	0.000	0.000	0.000	0.000
23	25-11-19 12:53:11	233.2	233.1	232.9	0.00	0.00	0.00	0.000	0.000	0.000	0.000	0.000	0.000	0.000	0.000	0.000	0.000
24	25-11-19 12:53:12	233.2	233.1	232.9	0.00	0.00	0.00	0.000	0.000	0.000	0.000	0.000	0.000	0.000	0.000	0.000	0.000
25	25-11-19 12:53:13	233.3	233.2	233.0	0.00	0.00	0.00	0.000	0.000	0.000	0.000	0.000	0.000	0.000	0.000	0.000	0.000
26	25-11-19 12:53:15	233.2	233.2	233.0	0.00	0.00	0.00	0.000	0.000	0.000	0.000	0.000	0.000	0.000	0.000	0.000	0.000
27	25-11-19 12:53:16	233.1	233.1	232.9	0.00	0.00	0.00	0.000	0.000	0.000	0.000	0.000	0.000	0.000	0.000	0.000	0.000
28	25-11-19 12:53:16	232.9	232.9	232.6	0.00	0.00	0.00	0.000	0.000	0.000	0.000	0.000	0.000	0.000	0.000	0.000	0.000

Figure 11-2: RT Data Monitor Set#3 – RT measurement

Polling Options

To change the polling options, click on the Data Monitor window with the right mouse button and select Options.

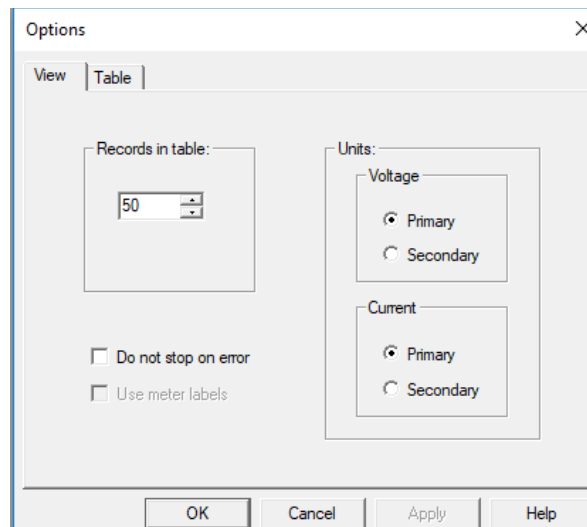

Figure 11-3: RT Data Monitor Set#3 – Polling options

If you check “Do not stop on errors”, polling is resumed automatically when a communication error occurs, otherwise polling stops until you restart it manually.

Viewing a Data Table

Changing the Data View

PAS displays data in either a single record or multi-record view. To change the view, click on the Data Monitor window with the right mouse button and select either Wrap to see a single record, or UnWrap to go to the multi-record view.



Adjusting the Number of Rows in a Multi-Record View

Click the window with the right mouse button, select Options, adjust the number of records you want to see in the window, and then click OK. When the number of retrieved records exceeds the number of rows in the window, the window scrolls up so that older records are erased.

Selecting Primary and Secondary Units

Voltages and currents can be displayed in primary or secondary units. To select primary or secondary units for your data views, click on the monitor window with the right mouse button, select Options, select the desired units for voltages and currents, and then click OK.

Viewing Data Trend

To view a data trend, click on the  button on the local toolbar. To change the time range for your graph, click on the  button on the local toolbar, and then select the desired date and time range.

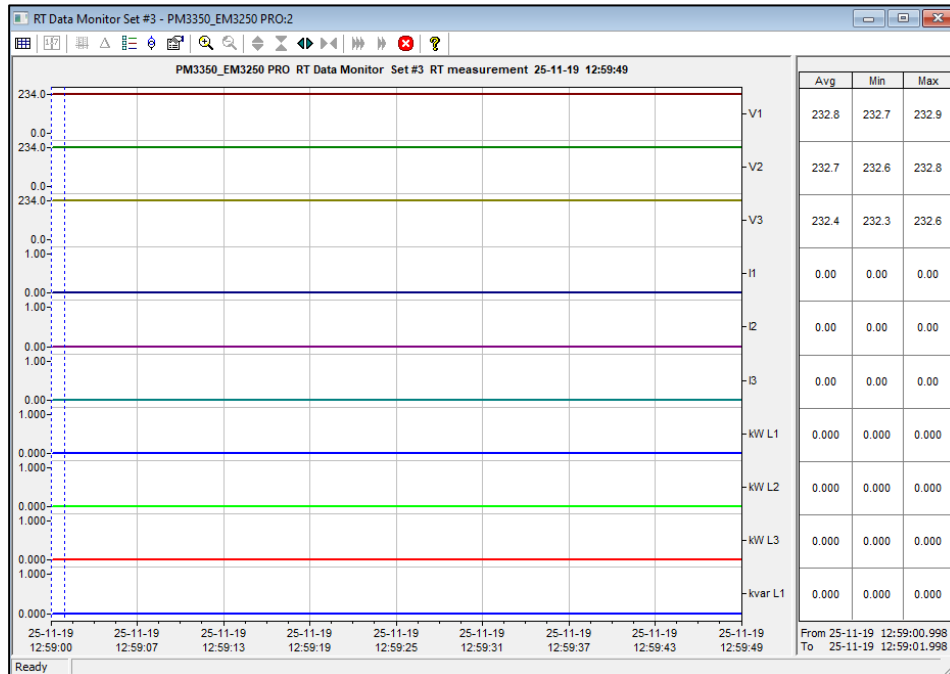

Figure 11-4: RT Data Monitor Set#3 – Data trend

Selecting Channels

To select data channels for your trend, click on the trend window with the right mouse button, select “Channels”, check the channels you want displayed, and then click OK.

Customizing Line Colors and Styles

Trend lines for different channels can be shown in different colors using different line styles. To change the colors or line styles, click on the trend window with the right mouse button, select “Options...”, click on the “Display” tab, adjust colors and styles for channels, and then click OK. You can also change the colors for the background and gridlines.

Using the Marker Lines

The trend window has two blue dashed marker lines. The left marker indicates the starting position for calculating the average and peak values, and the right marker indicates the end position.



To change the marker position, click on the trend window with the right mouse button and select Set Marker, or click on the  button on the window toolbar, and then click with left mouse button on the point where you want to put the marker. You can also drag both markers with the mouse, or use the right and left arrow keys on your keyboard to change the marker position. Click on the trend pane with the mouse before using the keyboard, to allow the keyboard to get your input.

Delta Measurements

To measure the distance between two trend points, click on the Delta button  on the toolbar, click with the left mouse button on the first point, and then click on the second point. The first reference point is frozen until you close and reopen Delta, while the second point can be placed anywhere within the trend

line. You can measure a delta in both directions. To disable Delta, click on the Delta button again.

Using a Zoom

You can use a horizontal and a vertical zoom to change size of your graph. Use the buttons  on your local toolbar representing green arrowheads to zoom in or out of the trend graph. Every click on these buttons gives you a 100-percent horizontal zoom. Two buttons  representing a magnifying glass give you a proportional zoom in both directions.

Saving Data to a File



To save retrieved data to a file for later analysis, click on the Save button , select a directory where you want your log files to be stored, select a database or type the name for a new database, and then click Save. To avoid confusion, do not store data files into the "Sites" directory where site databases are located.

Printing Data

To print retrieved data, click the  button on the PAS toolbar, select a printer, and then click OK. To check the report, as it will look when printed, select Print Preview from the File menu.

Copying Data

To copy the entire data table or a part of a table into the Clipboard or into another application such as Microsoft Excel or Word:

1. Click on the Data Monitor window with the right mouse button and choose Select All, or click on the upper-left corner of the data table (where the "No." label is displayed).
2. Click on the Data Monitor window with the right mouse button again and choose Copy or click on the Copy button  on the PAS toolbar.
3. Run an application to where you want to copy data, position cursor at the correct place, and then click on the Paste button  on the application's toolbar, or select Paste from the Edit menu.

If you want only a part of data to be copied, select with the mouse while holding the left mouse button the rows or columns in the table you want to copy, and then click on the Copy button  on the PAS toolbar.

Real-time Data Logging

PAS allows you to log polled data records to a database automatically at the time it updates the Data Monitor window on the screen.

To setup the real-time logging options:



1. Open the Data Monitor window.
2. Click on the "RT Logging On/Off"  button on the local toolbar, or select "RT Logging Options" from the Tools menu.
3. Select a database, or type the name for a new database and select a directory where you want to save it.
4. Select the number of tables, and the number of records in each table you want recorded.
5. Adjust the file update rate for automatic recording. It must be a multiple of the sampling rate that you defined in the Instrument Setup dialog.
6. Click Save.

When you run real-time data polling, PAS automatically saves retrieved records to the database at the rate you specified. The "RT Logging On/Off" button  on the toolbar should be checked all the time to allow PAS to perform logging. You can suspend logging by un-checking this button, and then resume logging by checking it again.

Viewing Real-time Min/Max Log

To retrieve the real-time Min/Max log data from your device, select the device site from the list box on the PAS toolbar, point to RT Min/Max Log on the Monitor menu, and then select a data set you want to view.



PAS supports nine programmable data sets with up to 40 data parameters in each one. To re-organize data sets, select Data Set from the Monitor menu or click on the  button on the toolbar. You can modify data sets in the way that is convenient for your use.

To retrieve the selected Min/Max log data, check the On-line button  on the PAS toolbar, and then click on the Poll button .

You can save retrieved data to a file or print it in the same manner as described in the previous section.

Viewing Real-time Waveforms

To retrieve the real-time waveforms from your device, select the device site from the list box on the toolbar, and then select RT Waveform Monitor from the Monitor menu.

To retrieve waveforms, check the On-line button  on the PAS toolbar, and then click on either the Poll button  or Continuous poll button . Click on the Stop button  to stop continuous polling.



PAS normally retrieves eight 4-cycle AC waveforms (V1-V4 and I1-I4) sampled at a rate of 128 samples per cycle. If you wish to get only waveforms for selected phases, select "Options" from the Tools menu, click on the Preferences tab, check the phases you want polled, and then click OK.

To view all waveforms, or to change channels displayed in the window, click on the waveform window with the right mouse button, select "Channels", check channels you want displayed, and then click OK.

Retrieved waveforms can be displayed in different views as overlapped or non-overlapped waveforms, as RMS cycle-by-cycle plot, or as a harmonic spectrum chart or table. See [Viewing Waveforms](#) in Chapter 13 for information on using different waveform views.

Viewing Real-time Min/Max Log



To retrieve the real-time Min/Max log data from your meter:

1. Select the device site from the list box on the PAS toolbar.
6. Point to RT Min/Max Log on the Monitor menu, and then select a data set you want to view.
7. Ensure that the On-line button  on the PAS toolbar is checked.
8. Click on the Poll button .

PAS supports 9 programmable data sets that you can organize as you wish. To build your data sets, select MinMax Data Sets from the Monitor menu or click on the  button on the local toolbar.

Viewing Real-time Waveforms

To retrieve real-time waveforms from your meter:

1. Ensure that the On-line button  on the PAS toolbar is checked.
9. Select the device site from the list box on the toolbar.
10. Select RT Waveform Monitor from the Monitor menu or click on the  button on the PAS toolbar.

Use the Poll button  for a single-step poll or the Continuous poll  button for continuous polling.

To stop continuous polling, click on the Stop button .

The meter provides simultaneous capture of six one-cycle voltage and current AC waveforms at a rate of 64 samples per cycle. To give you a more representative picture, PAS extends the waveforms across the window up to eight cycles by repeating the captured waveforms.

To select the channels you want to view, click with the right mouse button on the waveform window, select Channels..., check the channels for the phase you want displayed, and then click OK.

Retrieved waveforms can be displayed in different views as overlapped or non-overlapped waveforms, as RMS cycle-by-cycle plot, or as a harmonic spectrum chart or table.

Viewing a Waveform Graph

When you open a new file, PAS shows you a waveform graph with non-overlapped waveforms as shown in the picture above.

Click on the  button on the local toolbar to see overlapped waveforms.

Click on the  button for non-overlapped waveforms.

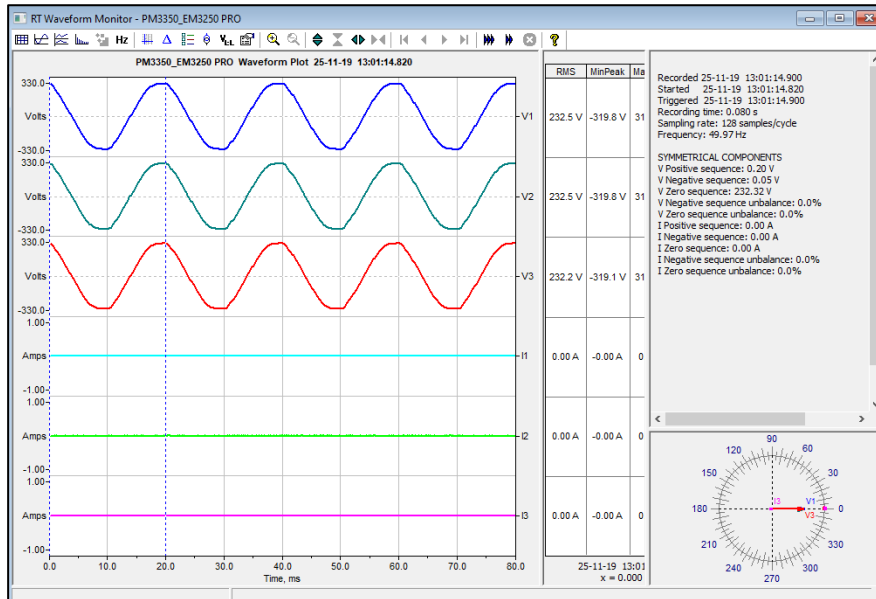



Figure 11-5: RT Waveform Monitor Window

Viewing a Frequency Plot

Click on the  button to view a cycle-by-cycle frequency plot for the sampled voltage waveforms.

Viewing a Harmonic Spectrum

Click on the  button to view a spectrum chart for the selected waveform channel. PAS provides voltage, current, active power and reactive power spectrum charts. See [Viewing Real-time Harmonic Spectrum](#) for more information on viewing options.

Viewing Phasor Diagrams

The phasor diagrams show you relative magnitudes and angles of the three-phase voltage and current fundamental component. All angles are shown relative to the reference voltage channel.

To change the reference channel, click on the waveform window with the right mouse button, select Options..., click on the Phasor tab, check the channel you want to make a reference channel, and then click OK.

Viewing Symmetrical Components

Waveform views have an additional pane at the right where PAS displays the symmetrical components for voltages and currents, calculated for the point indicated by the left marker line.

To enable or disable the symmetrical components, click on the waveform window with the right mouse button, select Options..., check or uncheck the Symmetrical components box on the Channels tab, and then click OK.



Viewing Phase-to-phase Voltages



PAS can transform phase-to-neutral voltage waveforms in configurations with a neutral into phase-to-phase waveforms allowing you to view the waveshape, angle relationships and harmonics of the phase-to-phase voltages.

Click on the  button on the waveform window toolbar. Click the button once again to return to phase-to-neutral waveforms.

Viewing Real-time Harmonic Spectrum

To retrieve real-time harmonic spectrum from your meter:

11. Ensure that the On-line button  on the PAS toolbar is checked.
12. Select the device site from the list box on the toolbar.
13. Select RT Harmonic Monitor from the Monitor menu or click on the  button on the PAS toolbar.

Click on the “Poll”  or “Continuous poll”  button to poll the meter once or continuously. Click on the Stop button  to stop continuous polling.

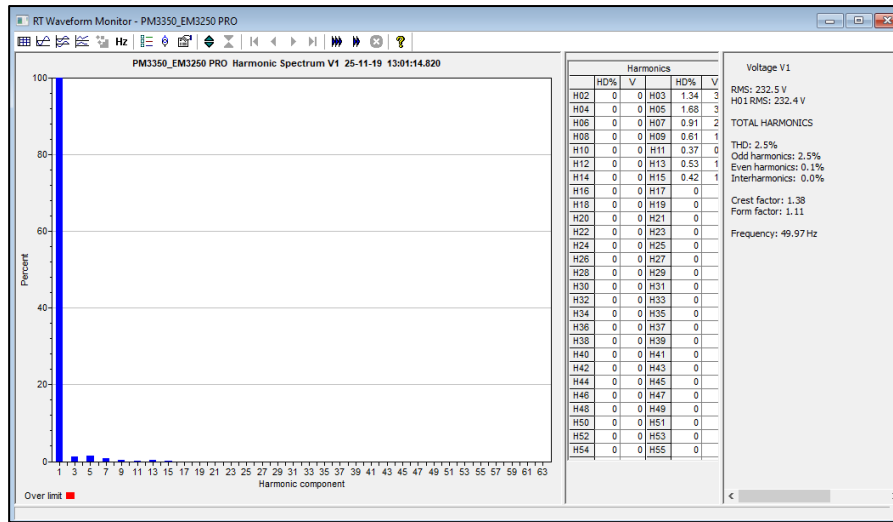



Figure 11-6: RT Harmonic Monitor – Spectrum Chart

PAS retrieves harmonic spectrum for V1-V3 and I1-I3 channels. Harmonics can be displayed as a spectrum chart for a selected channel or in a table. PAS can also synthesize waveforms based on the harmonic spectrum to let you view a shape of the voltage and current waveforms in your network.

Viewing a Spectrum Chart

Click on the  button to view a spectrum chart for the selected channel. To change a channel, click on the window with the right mouse button, select Channels..., check the channel you want displayed, and then click OK. PAS provides voltage, current, active power and reactive power spectrum charts.

PAS can give you indication on whether harmonic levels in the sampled waveforms exceed compliance limits defined by the power quality standards or local regulations.

To review or change harmonic limits:

1. Click on the spectrum window with the right mouse button and select Limits....
2. Select a known harmonics standard, or select Custom and specify your own harmonic limits.
3. Check the Enabled box to visualize harmonic faults on the spectrum graph and in harmonic tables.

Harmonics that exceed selected compliance levels are colored in red on the graph and in the tables.

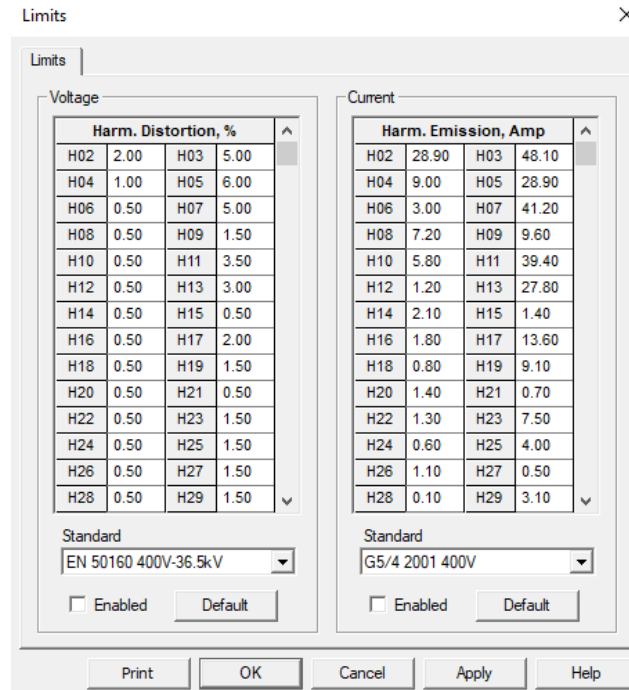

Figure 11-7: Harmonic Limits

Viewing a Spectrum Table

Click on the button on the local toolbar to display the harmonics spectrum in a tabular view for a selected phase or for all phases together.

The spectrum table shows voltage, current, active power and reactive power harmonic components both in percent of the fundamental and in natural units, and harmonic phase angles.

To change a phase, click on the window with the right mouse button, select Options..., check the phase you want displayed, and then click OK.

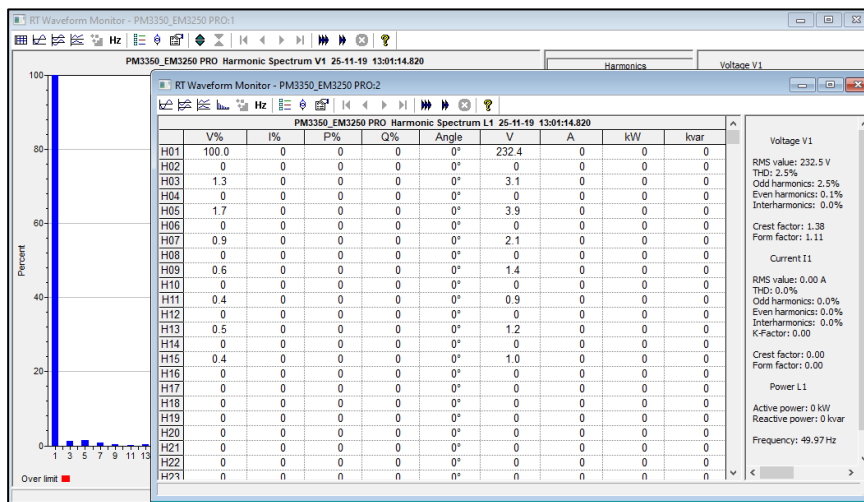

Figure 11-8: RT Harmonic Monitor – Spectrum Table

Viewing Synthesized Waveforms

To view the synthesized waveforms based on the sampled harmonic spectrum, click on the button on the local toolbar to view non-overlapped voltage and current waveforms, or click on the button to view them overlapped.

PAS shows a pair of 4-cycle voltage and current synthesized AC waveforms for a single phase.

To select the channels you want to view, click with the right mouse button on the waveform window, select "Channels...", check the channels for the phase you want displayed, and then click OK.

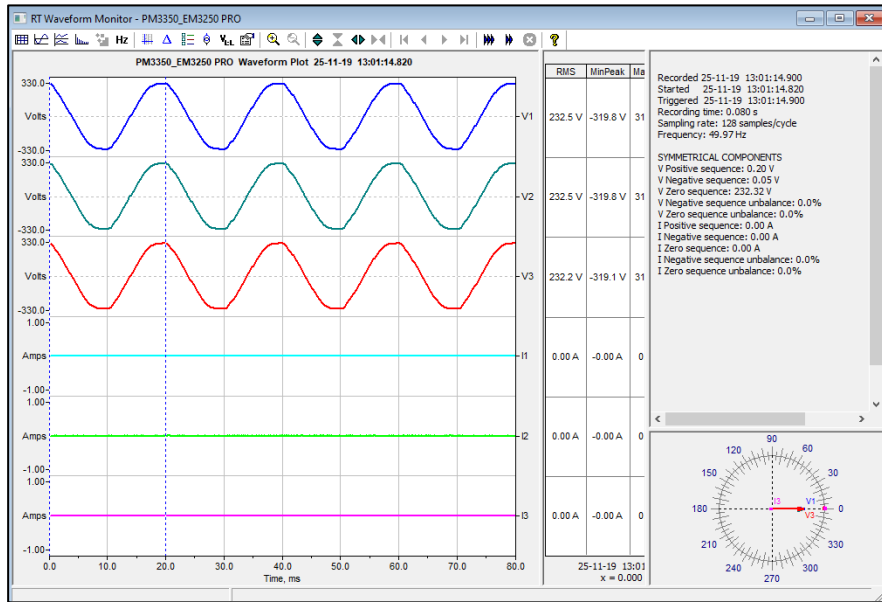

Figure 11-9: RT Harmonic Monitor – Synthesized Waveforms

Chapter 12 Retrieving and Storing Files

Using PAS, you can retrieve recorded events, data and waveforms from your devices and save them to files on your PC in the MS Access database format.

Historical data can be uploaded on demand any time you need it, or periodically through the Upload Scheduler that retrieves data automatically on a predefined schedule, for example, daily, weekly or monthly. If you do not change the destination database location, the new data is added to the same database so you can store long-term data profiles in one database regardless of the upload schedule you selected.

Uploading Files on Demand

To retrieve the log files from your device:

1. Select a device site from the list box on the PAS toolbar.
2. Check the On-line button .
3. Select Upload Logs from the Logs menu.

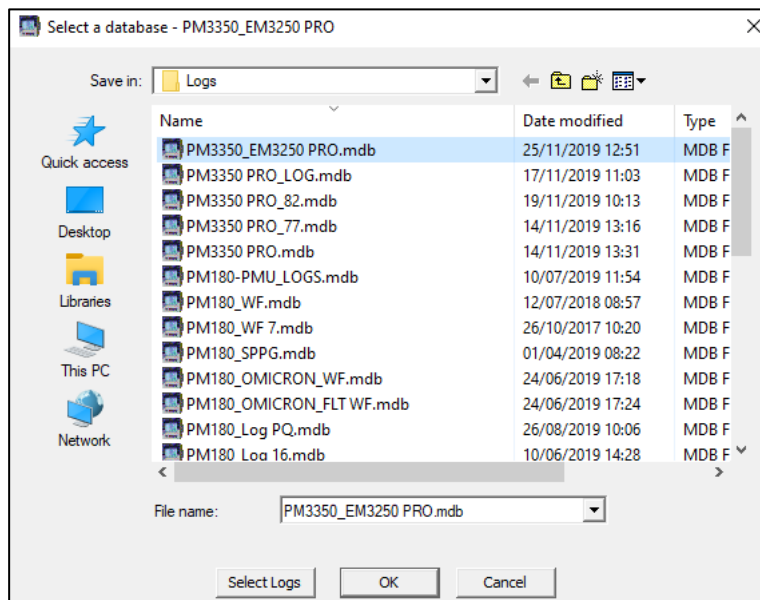

4. Select a database, or type the name for a new database, and select a directory where you want to save it.
5. Click on the “Select Logs” button and check boxes for logs you want to be retrieved from the device.

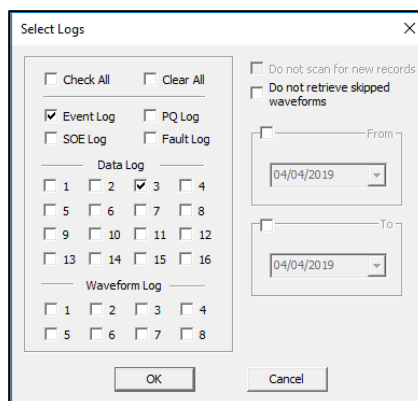

6. If you wish to retrieve data starting with a known date, check the “From” box and select the start date for retrieving data.
7. If you wish to retrieve data recorded before a known date, check the “To” box and select the last date for retrieving data.
8. Click OK.

Using the Upload Scheduler

To setup the Upload Scheduler:

1. Select Upload Scheduler from the Logs menu.

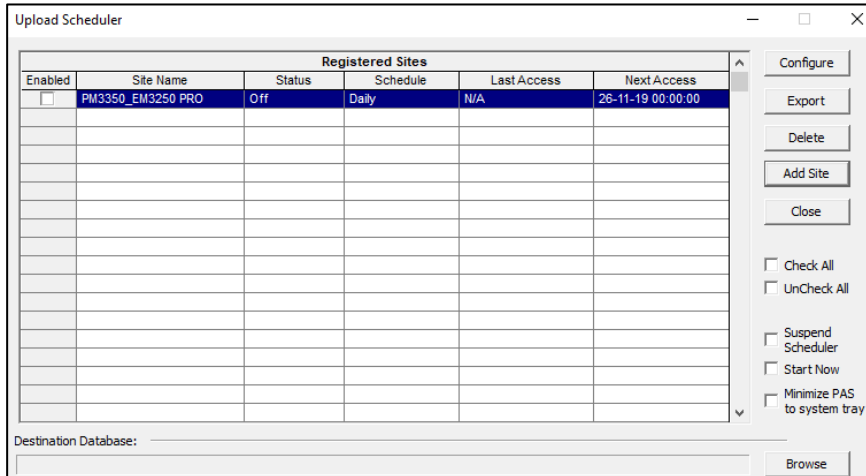

2. Click Add Site, point to the site database for which you want to organize the schedule, and then click OK.
3. Click Browse and select a database for storing retrieved data, or type the name for a new database, select a directory where you want to save it, and then click OK.
4. Click Configure or double click on the site row.

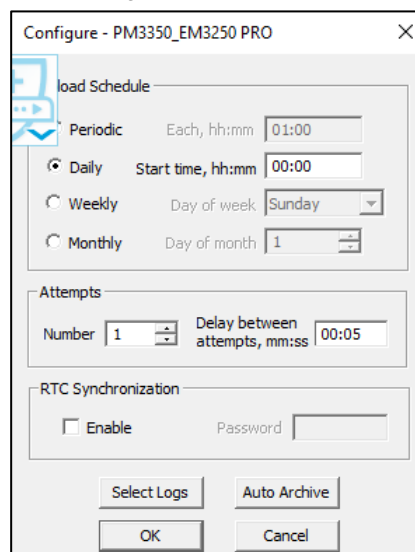

5. Select a daily, weekly or monthly schedule, and adjust the start time. If you wish to upload data periodically in predefined intervals, click on “Periodic” and define the time period in hours and minutes.

6. Select the number of attempts to upload data in the event of temporary communication problems or unavailability of your device, and the delay between attempts in minutes and seconds.
7. If you wish to use the schedule to synchronize the device clock with your PC, check the "RTC Synchronization Enable" box. If your device is password protected by a communications password, type in the password you set in the device to allow PAS to update the clock.
8. Click on the Select Logs button, check the boxes for logs you want to upload on a schedule, and then click OK.
9. Check the Enabled box at left to activate a schedule for the device.
10. Click OK to store your schedule.

To keep the Upload Scheduler running, the On-line button  on the PAS toolbar must be checked all the time. If you uncheck it, the scheduler stops operations. This does not cause loss of data, since the scheduler will resume operations when you check this button again.

Suspending the Scheduler

To suspend the Upload Scheduler, check the Suspend Scheduler box at right. To activate the Upload Scheduler, leave this box unchecked.

Running the Scheduler on Demand

You can run the scheduler at any time outside the schedule by checking the Start Now box at right. This is a one-time action. After uploading is completed, the Upload Scheduler un-checks this box automatically.

Reviewing Upload Problems

When the Upload Scheduler fails to retrieve data from the device, or some data is missing, or another problem occurs, it puts an error message to the log file. To review this file, select System Log from the View menu.

Chapter 13 Viewing Files On-line



General Operations

Opening a Log File

To open a log file, click on the Open button  on the PAS toolbar, or select "Open..." from the File menu. In the "Files of type" box, select "Access Database (*.mdb)", select a directory where your files are located, point to the file you want to open, select a desired table on the right pane, and then click Open.

Copying Data

To copy the entire data table or graph, or part of the data, into the Clipboard or into another application such as Microsoft Excel or Word:

1. Click on the data window with the right mouse button and choose Select All, or, if your current view represents a table, click on the upper-left corner of the table (where the "No." label is commonly displayed).
2. Click with the right mouse button on the window again and choose Copy, or click on the Copy button  on the PAS toolbar.
3. Run the application to which you want to copy data, position the cursor at the correct place, and then click the Paste button  on the application's toolbar or select Paste from the Edit menu.

Saving Data to a File

To save data to a file, click on the Save button , select a directory where you want your log file to be stored, select a database or type the name for a new database, and then click Save. To avoid confusion, do not store data files into the "Sites" directory where site databases are located.

Printing Reports

To print a data report to a printer, click on the print button  on the toolbar, select a printer and click OK. If you want to check how your document appears on the printed page, select Print Preview from the File menu.

Customizing Views

Date Order

To change the way PAS displays the date, select Options from the Tools menu, click on the Preferences tab, select the preferred date order, and then click OK.

Timestamp

The timestamp is normally recorded and displayed on the screen at a 1-ms resolution. If you have an application that does not support this format, you may instruct PAS to drop the milliseconds. To change the way PAS records and displays the timestamp, select Options from the Tools menu, click on the Preferences tab, select the preferred timestamp format, and then click OK.

Voltage Disturbance Units

When programming a voltage disturbance trigger in your device, the operate limit for the trigger can be set either in a percent of the nominal voltage, or in voltage RMS units. To change the disturbance units, select Options from the Tools menu, click on the Preferences tab, select the preferred units, and then click OK.

Viewing Options

Customizing Views

Changing Date Order

To change the way PAS displays the date:

1. Select Options from the Tools menu and click on the Preferences tab.
 1. Select the preferred date order.
 2. Click OK.

Selecting Timestamp Format

The timestamp is normally recorded and displayed on the screen at a 1-ms resolution. If you have an application that does not support this format, you may instruct PAS to drop milliseconds.

To change the way PAS records and displays the timestamp:

1. Select Options from the Tools menu and click on the Preferences tab.
2. Select the preferred timestamp format.
3. Click OK.

Working with Tables

Selecting Font and Grid

To change the table font or a type of the grid lines:

1. Click with right mouse button on the table, select Options and click on the Table tab.
2. Select the font type and size and how you wish the table grid to be shown.
3. Click OK.



Selecting Primary and Secondary Units

Voltages and currents can be displayed in primary or secondary units.

To change units, click on the table with the right mouse button, select Options, select the desired units for voltages and currents, and then click OK.

Copying a Table

To copy the entire table, or its part, into the Clipboard or into another application such as Microsoft Excel or Word:

1. Click on the data window with the right mouse button and choose Select All, or click on the upper-left corner of the table (where the "No." label is commonly displayed).
2. Click with the right mouse button on the window again and choose Copy, or click on the Copy button  on the PAS toolbar.
3. Run the application to which you want to copy data, position the cursor at the correct place.
4. Click the Paste button  on the application's toolbar or select Paste from the Edit menu.

When copying, table columns are separated by a tab character.

Printing a Table

To check how your document appears on a printed page, select Print Preview from the File menu.

To print a table to a printer, click on the print button  on the toolbar, select a printer and click OK.

Working with Graphic Windows

Selecting Channels

To select the channels you want to view on the screen, click on the graph window with the right mouse button, select Channels..., check the channels you want displayed, and then click OK.

Checkboxes for channels that are not available in the present view are dimmed.

Selecting Primary and Secondary Units

Voltages and currents can be displayed in primary or secondary units.

To change units, click on the table with the right mouse button, select Options, select the desired units for voltages and currents, and then click OK.

Selecting the Time Axis

In waveform views, the horizontal axis can be displayed either in absolute time with date and time stamps, or in milliseconds relatively to the beginning of a waveform.

To change the time units, click on the waveform window with the right mouse button, select Options..., click on the Axes tab, select the desired units, and then click OK.

Selecting Line Styles and Colors

Channel waveforms can be displayed using different colors and line styles.

To change the colors or line styles, click on the graph window with the right mouse button, select Options..., click on the Display tab, adjust colors and styles, and then click OK.

Selecting Grid and Frame Colors

Click on the graph window with the right mouse button, select Options..., and click on the Display tab

To change the color or style of the grid lines, click on the Grid line on the left pane, and then select the color and style for the grid. To disable the grid, uncheck the Grid Visible box.

To change the window frame color to white, check the White Frame box at right.

Using Marker Lines

The waveform and trend windows have two blue dashed marker lines. The left marker indicates the starting position and the right marker indicates the end position for calculating the average and peak values.

The minimum distance between the two markers is exactly one cycle.

To change the marker position, click on the  button, or click on the window with the right mouse button and select Set Marker, and then click on the point where you want to put the marker.

You can also drag both markers with the mouse, or use the right and left arrow keys on your keyboard to change the marker position. Click on the graph pane to allow the keyboard to get your input before using the keyboard.

Delta Measurements



To measure the distance between two waveform or trend points, click on the Delta button , then click on the first point, and then click on the second point.

The first reference point is still frozen until you uncheck and check the Delta button again, while the second point can be placed anywhere within the graph line by clicking on the graph to the left or right from the reference point.

To disable delta measurements, click on the Delta button once again.

Using a Zoom

You can use a horizontal and, for waveforms, also a vertical, zoom to change size of your graph.

Use the  buttons on your local toolbar to zoom in and zoom out. One click gives you a 100-percent horizontal or 50-percent vertical zoom. Two buttons  representing magnifying glasses give you a proportional zoom in both directions.

Copying a Graph

To copy a graph, or its part, into the Clipboard or into another application such as Microsoft Excel or Word:

1. Click on the graph window with the right mouse button and choose Copy All, or Copy Waveform. Some windows may have additional options.
2. Position the cursor at the place where you wish to copy the graph.
3. Click the Paste button  on the application's toolbar or select Paste from the Edit menu.

Printing a Graph

To check how the graph appears on a printed page, select Print Preview from the File menu.

To print a graph to a printer, click on the Print button  on the PAS toolbar, select a printer and click OK.

Viewing the Event Log

Event log files are displayed in a tabular view, one event per row. PAS loads the entire database table to a window, so that you can scroll through the entire log to view its contents.

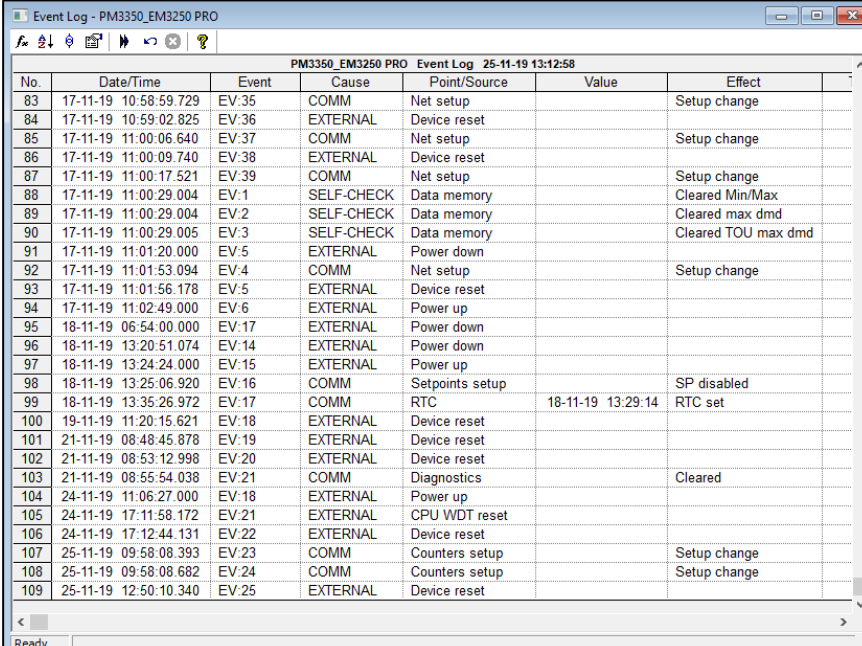

No.	Date/Time	Event	Cause	Point/Source	Value	Effect
83	17-11-19 10:58:59.729	EV:35	COMM	Net setup		Setup change
84	17-11-19 10:59:02.825	EV:36	EXTERNAL	Device reset		
85	17-11-19 11:00:06.640	EV:37	COMM	Net setup		Setup change
86	17-11-19 11:00:09.740	EV:38	EXTERNAL	Device reset		
87	17-11-19 11:00:17.521	EV:39	COMM	Net setup		Setup change
88	17-11-19 11:00:29.004	EV:1	SELF-CHECK	Data memory		Cleared Min/Max
89	17-11-19 11:00:29.004	EV:2	SELF-CHECK	Data memory		Cleared max dmd
90	17-11-19 11:00:29.005	EV:3	SELF-CHECK	Data memory		Cleared TOU max dmd
91	17-11-19 11:01:20.000	EV:5	EXTERNAL	Power down		
92	17-11-19 11:01:53.094	EV:4	COMM	Net setup		Setup change
93	17-11-19 11:01:56.178	EV:5	EXTERNAL	Device reset		
94	17-11-19 11:02:49.000	EV:6	EXTERNAL	Power up		
95	18-11-19 06:54:00.000	EV:17	EXTERNAL	Power down		
96	18-11-19 13:20:51.074	EV:14	EXTERNAL	Power down		
97	18-11-19 13:24:24.000	EV:15	EXTERNAL	Power up		
98	18-11-19 13:25:06.920	EV:16	COMM	Setpoints setup		SP disabled
99	18-11-19 13:35:26.972	EV:17	COMM	RTC	18-11-19 13:29:14	RTC set
100	19-11-19 11:20:15.621	EV:18	EXTERNAL	Device reset		
101	21-11-19 08:48:45.878	EV:19	EXTERNAL	Device reset		
102	21-11-19 08:53:12.998	EV:20	EXTERNAL	Device reset		
103	21-11-19 08:55:54.038	EV:21	COMM	Diagnostics		Cleared
104	24-11-19 11:06:27.000	EV:18	EXTERNAL	Power up		
105	24-11-19 17:11:58.172	EV:21	EXTERNAL	CPU WDT reset		
106	24-11-19 17:12:44.131	EV:22	EXTERNAL	Device reset		
107	25-11-19 09:58:08.393	EV:23	COMM	Counters setup		Setup change
108	25-11-19 09:58:08.682	EV:24	COMM	Counters setup		Setup change
109	25-11-19 12:50:10.340	EV:25	EXTERNAL	Device reset		

Selecting Primary and Secondary Units

Voltages and currents can be displayed in primary or secondary units. To select units for your data views, click on the monitor window with the right mouse button, select Options, select the desired units for

voltages and currents, and then click OK.

Filtering and Sorting Events

You can use filtering to find and work with a subset of events that meet the criteria you specify. Click on the Filter button , or click on the report window with the right mouse button and select "Filter...". Check the causes of events you want to display, and then click OK. PAS temporarily hides rows you do not want displayed.

To change the default sorting order based on the date and time, click on the Sort button , or click on the report window with the right mouse button and select "Sort...", check the desired sort order, and then click OK.

Linking to Waveforms and Data Records

If you programmed a setpoints to log setpoints operations to the Event log and the setpoints can trigger the Waveform or Data recorder, PAS automatically establishes links between the event and other database records where it finds a relationship with the event. Waveforms recorded at the time of the event are always linked to this event, even if the waveform was triggered by another source.

The event ID for which PAS finds related data is blue colored. Click on the colored event ID to check a list of the event links. Click on a list item to move to the related waveform or data log record.

Viewing the Power Quality Log

PQ log files are displayed in a tabular view, one event per row. The PQ log normally contains both power quality and fault events. By default, the fault events are not displayed in the PQ report unless you enable them through the event filter (see below).

No.	Date/Time	Event	Fault Category	Phase	Fault Magnitude	PU
1	13-11-19 15:31:44.000	PQE7:3067	Frequency variation		49.95	0.833
2	13-11-19 15:48:17.079	PQE33:3068	Overvoltage	V1	233.2	1.01
3	13-11-19 15:55:59.651			V1	234.6	1.02
4	13-11-19 15:55:59.651			V2	234.5	1.02
5	13-11-19 15:55:59.651	PQE33:3071	Overvoltage	V3	234.3	1.01
6	13-11-19 15:58:15.000	PQE7:3072	Frequency variation		50.05	1.001
7	13-11-19 15:59:33.000	PQE7:3073	Frequency variation		50.07	1.001
8	13-11-19 16:42:34.407	PQE33:3076	Overvoltage	V1	234.2	1.01
9	13-11-19 16:42:34.407	PQE33:3076	Overvoltage	V2	234.2	1.01
10	13-11-19 16:42:34.407	PQE33:3076	Overvoltage	V3	234.0	1.01
11	13-11-19 16:51:21.996	PQE33:3075	Overvoltage	V1	233.5	1.01
12	13-11-19 16:51:21.996	PQE33:3075	Overvoltage	V2	233.5	1.01
13	13-11-19 16:51:21.996	PQE33:3075	Overvoltage	V3	233.3	1.01
14	13-11-19 16:51:39.000	PQE7:3076	Frequency variation		49.94	0.999
15	13-11-19 16:51:48.000	PQE7:3077	Frequency variation		49.95	0.999
16	13-11-19 16:54:24.404	PQE33:1	Overvoltage	V1	233.6	1.01
17	13-11-19 16:54:24.404	PQE33:1	Overvoltage	V2	233.6	1.01
18	13-11-19 16:54:24.404	PQE33:1	Overvoltage	V3	233.4	1.01
19	13-11-19 17:00:08.687	PQE33:3	Overvoltage	V1	233.7	1.01
20	13-11-19 17:00:08.687	PQE33:3	Overvoltage	V2	233.7	1.01
21	13-11-19 17:00:08.687	PQE33:3	Overvoltage	V3	233.5	1.01
22	13-11-19 17:00:24.000	PQE7:4	Frequency variation		50.06	1.001
23	13-11-19 17:02:12.000	PQE7:5	Frequency variation		49.95	0.999
24	13-11-19 17:33:12.000	PQE7:8	Frequency variation		49.94	0.999
25	13-11-19 17:33:21.000	PQE7:9	Frequency variation		49.95	0.999
26	13-11-19 19:08:33.000	PQE7:10	Frequency variation		50.06	1.001
27	14-11-19 08:42:39.000	PQE7:11	Frequency variation		49.95	0.999

Selecting Primary and Secondary Units

Voltages and currents can be displayed in primary or secondary units. To select units for your report, click on the report window with the right mouse button, select Options, select the desired units for voltages and currents, and then click OK.

Filtering and Sorting Events

To filter events, click on the Filter button , or click on the report window with the right mouse button and select "Filter...", check the categories of events you want to display, and then click OK.

To change the default event sorting order, click on the Sort button , or click on the report window with the right mouse button and select "Sort...", check the desired sort order, and then click OK.

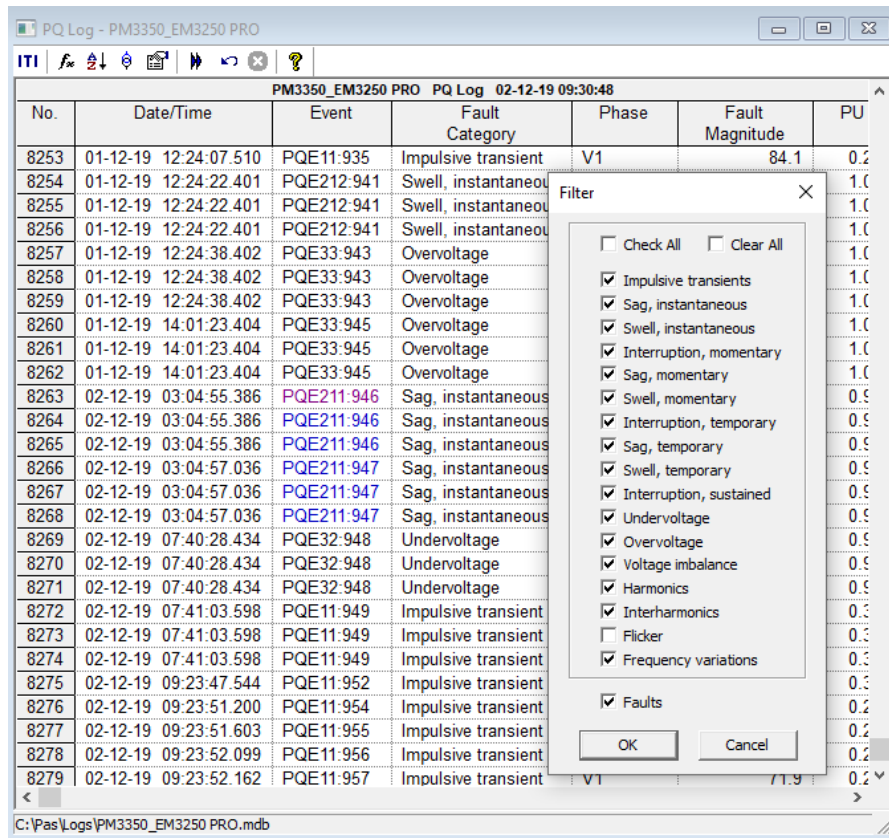

Linking to Waveforms and Data Records

PQ events for which PAS finds related links are blue colored. Click on the colored event ID to check a list of the event links. Click on a list item to move to the related waveform or data log records. Data log records associated with the event are taken into a separate window for easy viewing and trending.

Retrieving Waveforms Online

If you programmed the PQ recorder to record waveforms on power quality events, you can upload the waveforms related to a specific event online if they have not yet been retrieved and stored to the database on your PC. Events for which PAS did not find a corresponding waveform in the database are still black colored. Click on the event ID, click on the “Retrieve Waveform” prompt, and then point to a database to which you want the waveform to be stored.

Viewing the ITI (CBEMA) Curve

Impulsive transients and short-duration voltage variations (sags and swells) can be viewed as magnitude/duration pairs on the ITIC (the Information Technology Industry Council, formerly CBEMA) curve chart. To view an ITI curve chart, click on the "ITI" button on the window toolbar.

To view the event details, click on the event point with the left mouse button. To directly move to the related power quality report entry or to a waveform record, click on the corresponding list item with the left mouse button.

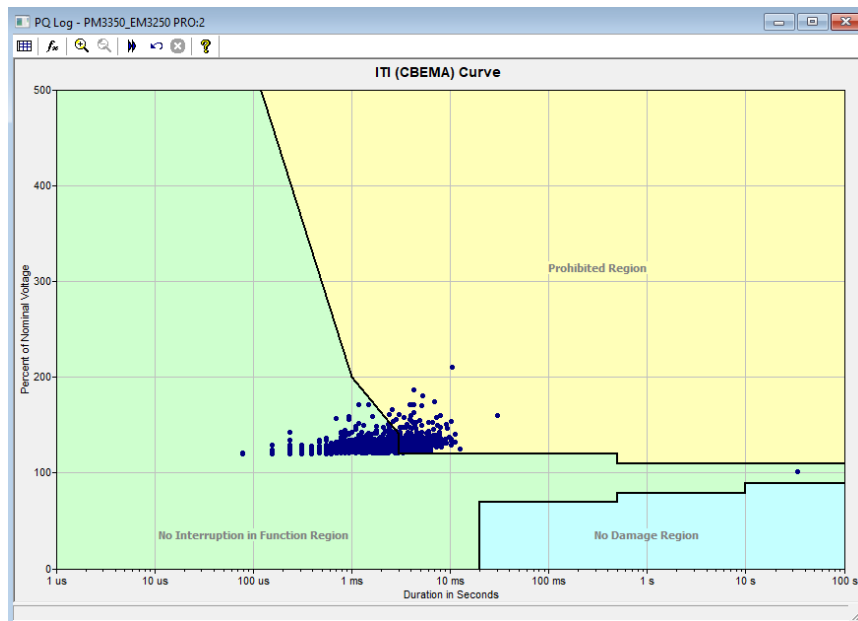

Viewing the Data Log

Data log files can be displayed in a tabular view, one data record per row, or in a graphical view as a data trend graph.

No.	Date/Time	Event	V1	V2	V3	I1	I2	I3	kW	kvar	kVA	PF	V1 THD	V2 THD
918	25-11-19 07:00:00.000	SP1	234.9	234.9	234.7	0.00	0.00	0.00	0.000	0.000	0.000	0.000	2.5	2
919	25-11-19 07:15:00.005	SP1	232.0	232.0	231.8	0.00	0.00	0.00	0.000	0.000	0.000	0.000	2.4	2
920	25-11-19 07:30:00.002	SP1	233.7	233.7	233.5	0.00	0.00	0.00	0.000	0.000	0.000	0.000	2.0	2
921	25-11-19 07:45:00.002	SP1	233.5	233.5	233.3	0.00	0.00	0.00	0.000	0.000	0.000	0.000	2.4	2
922	25-11-19 08:00:00.002	SP1	233.9	233.8	233.6	0.00	0.00	0.00	0.000	0.000	0.000	0.000	2.2	2
923	25-11-19 08:15:00.004	SP1	233.2	233.1	232.9	0.00	0.00	0.00	0.000	0.000	0.000	0.000	2.6	2
924	25-11-19 08:30:00.007	SP1	235.1	235.0	234.8	0.00	0.00	0.00	0.000	0.000	0.000	0.000	2.3	2
925	25-11-19 08:45:00.006	SP1	234.7	234.7	234.5	0.00	0.00	0.00	0.000	0.000	0.000	0.000	2.4	2
926	25-11-19 09:00:00.007	SP1	234.4	234.3	234.2	0.00	0.00	0.00	0.000	0.000	0.000	0.000	2.3	2
927	25-11-19 09:15:00.003	SP1	233.7	233.7	233.5	0.00	0.00	0.00	0.000	0.000	0.000	0.000	2.3	2
928	25-11-19 09:30:00.009	SP1	233.3	233.2	233.0	0.00	0.00	0.00	0.000	0.000	0.000	0.000	2.4	2
929	25-11-19 09:45:00.006	SP1	233.6	233.6	233.3	0.00	0.00	0.00	0.000	0.000	0.000	0.000	2.4	2
930	25-11-19 10:00:00.003	SP1	233.8	233.7	233.5	0.00	0.00	0.00	0.000	0.000	0.000	0.000	2.5	2
931	25-11-19 10:15:00.002	SP1	233.6	233.5	233.4	0.00	0.00	0.00	0.000	0.000	0.000	0.000	2.3	2
932	25-11-19 10:30:00.005	SP1	232.2	232.1	231.9	0.00	0.00	0.00	0.000	0.000	0.000	0.000	2.3	2
933	25-11-19 10:45:00.004	SP1	232.9	232.9	232.7	0.00	0.00	0.00	0.000	0.000	0.000	0.000	2.4	2
934	25-11-19 11:00:00.002	SP1	233.5	233.4	233.2	0.00	0.00	0.00	0.000	0.000	0.000	0.000	2.5	2
935	25-11-19 11:15:00.005	SP1	233.4	233.4	233.2	0.00	0.00	0.00	0.000	0.000	0.000	0.000	2.5	2
936	25-11-19 11:30:00.000	SP1	234.6	234.4	234.2	0.00	0.00	0.00	0.000	0.000	0.000	0.000	2.5	2
937	25-11-19 11:45:00.006	SP1	233.1	233.1	232.9	0.00	0.00	0.00	0.000	0.000	0.000	0.000	2.4	2
938	25-11-19 12:00:00.006	SP1	233.4	233.4	233.2	0.00	0.00	0.00	0.000	0.000	0.000	0.000	2.3	2
939	25-11-19 12:15:00.004	SP1	233.9	233.8	233.6	0.00	0.00	0.00	0.000	0.000	0.000	0.000	2.5	2
940	25-11-19 12:30:00.008	SP1	232.9	232.8	232.6	0.00	0.00	0.00	0.000	0.000	0.000	0.000	2.4	2
941	25-11-19 12:45:00.005	SP1	232.5	232.4	232.2	0.00	0.00	0.00	0.000	0.000	0.000	0.000	2.4	2
942	25-11-19 13:00:00.009	SP1	232.8	232.7	232.5	0.00	0.00	0.00	0.000	0.000	0.000	0.000	2.5	2
943	25-11-19 13:15:00.006	SP1	233.2	233.1	232.9	0.00	0.00	0.00	0.000	0.000	0.000	0.000	2.5	2

Viewing Data Trend

To view data in a graphical form, click on the Data Trend  button on the local toolbar.

To change the time range for your graph, click on the Time Range button  on the local toolbar, and then select the desired date and time range.

Selecting Channels

To select desired data channels for your trend, click on the trend window with the right mouse button, select “Channels”, check the channels you want displayed, and then click OK.

Customizing Line Colors and Styles

Trend lines for different channels can be shown in different colors using different line styles. To change the colors or line styles, click on the trend window with the right mouse button, select “Options...”, click on the “Display” tab, adjust colors and styles for channels, and then click OK. You can also change the colors for the background and gridlines.

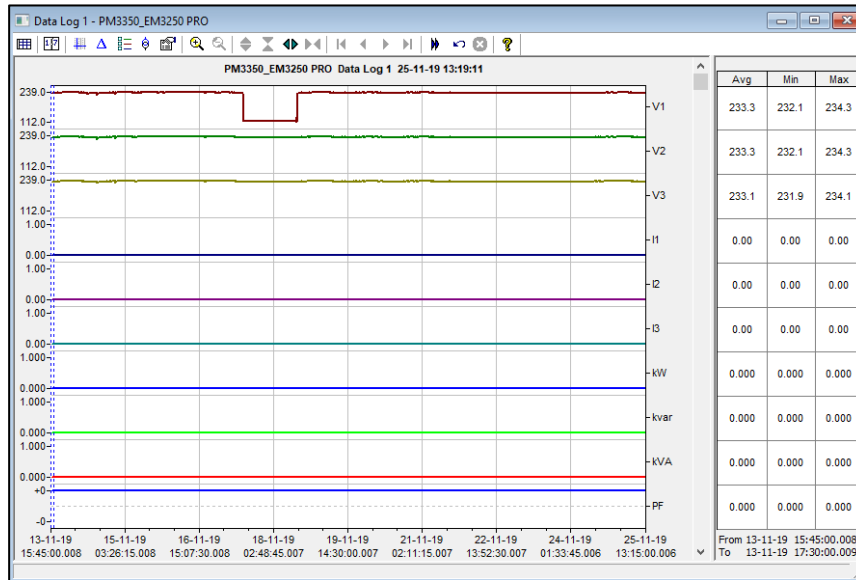



Using the Marker Lines

The trend window has two blue dashed marker lines. The left marker indicates the starting position and the right marker indicates the end position for calculating the average and peak values.

To change the marker position, click on the trend window with the right mouse button, select Set Marker, or click on the  button on the window toolbar, and then click with left mouse button on the point where you want to put the marker. You can also drag both markers with the mouse, or use the right and left arrow keys on your keyboard to change the marker position (click on the trend pane with the mouse before using the keyboard, to allow the keyboard to receive your input).

Using a Zoom

You can use a horizontal and a vertical zoom to change size of your graph. Use the  buttons on your local toolbar representing green arrowheads to zoom in and zoom out. One click gives you a 100-percent horizontal zoom. Two buttons  representing magnifying glasses give you a proportional zoom in both directions.

Delta Measurements



To measure the distance between two trend points, click on the Delta button , then click on the first point, and then click on the second point. The first reference point is still frozen until you close and reopen Delta, while the second point can be placed anywhere within the trend line. You can measure a delta in both directions. To disable delta measurements, click on the Delta button once again.

Viewing Waveforms

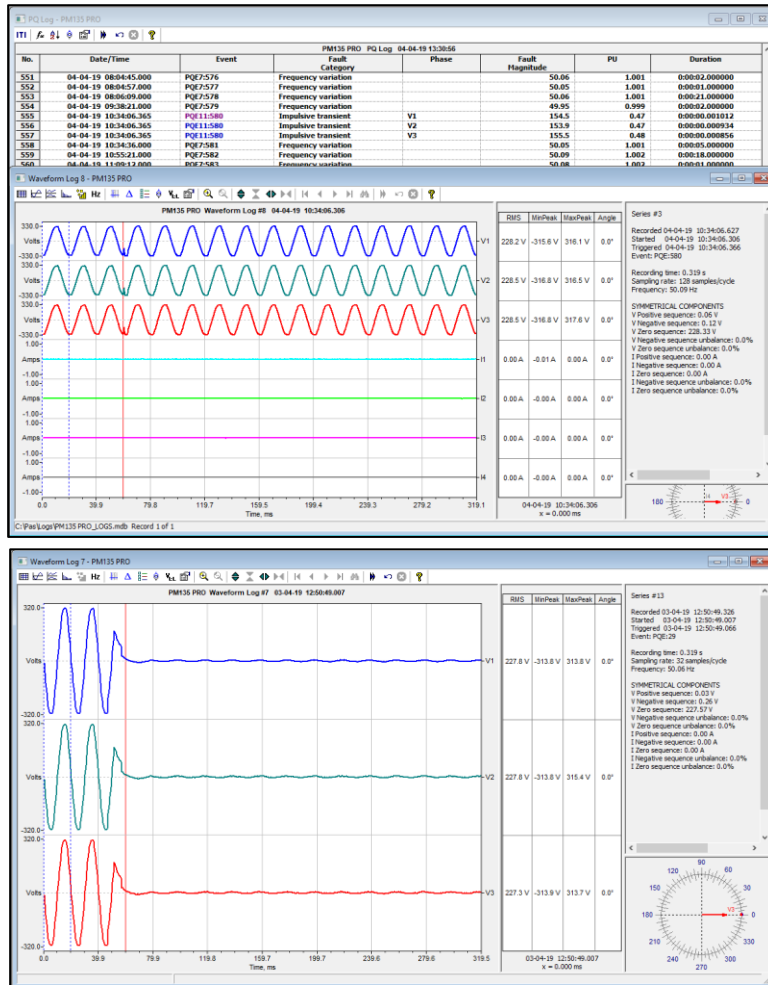
Waveform data can be displayed in five different views. When you open a new file, PAS shows you a waveform graph showing non-overlapped waveforms. Each waveform window has a local toolbar from where you can open another window to examine the waveform in a different view.



You can open all five views together to analyze different properties of the waveform like a wave shape, waveform disturbance, unbalance, or spectrum. When you move to another waveform record, all views are updated simultaneously to reflect the changes.

To view overlapped waveforms, click on the  button on the local toolbar; to view non-overlapped waveforms, click on the  button.

Waveform data is recorded in series that may contain many cycles of the sampled waveform. A waveform window displays up to 128 waveform cycles. If the waveform contains more cycles, the scroll bar appears under the waveform pane allowing you to scroll through the entire waveform.

Viewing an RMS Plot

PAS can show you a cycle-by-cycle RMS plot of the sampled AC waveforms. To open the RMS view, click on the  button. The graph shows the RMS points updated each half cycle.

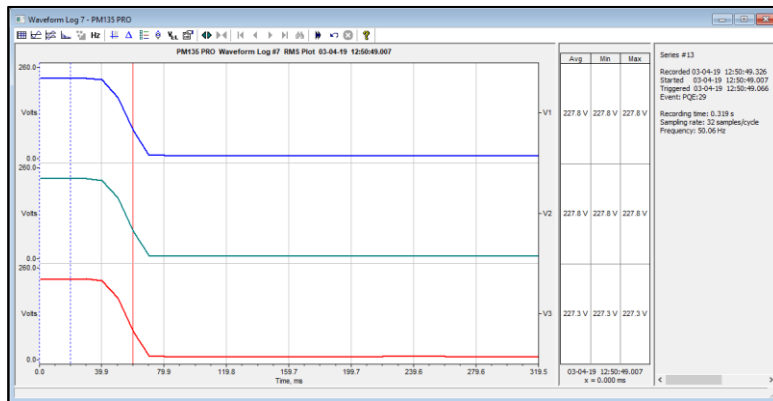

Viewing a Frequency Plot

To view a cycle-by-cycle frequency plot of the sampled voltage waveforms, click on the  button.

Viewing a Spectrum Chart

Click on the  button to view a spectrum chart for the selected waveform channel. To change a channel, click on the window with the right mouse button, select "Channels...", check the channel you want displayed, and then click OK. PAS provides voltage, current, active power and reactive power spectrum charts.

A spectrum is calculated over four cycles of the waveform beginning from the point where the left marker line is located in the open waveform view. If both waveform views are open, PAS gives the priority to the overlapped waveform view.

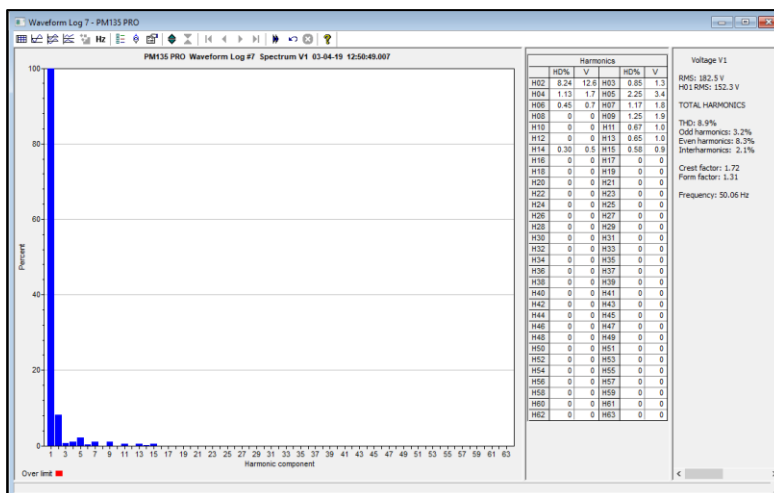

The order of the highest displayed harmonic component is equal to the half sampling rate at which the waveforms are sampled minus one. If the waveform was sampled at a rate of 256 samples per cycle, 63 harmonics are available. With 32 samples per cycle, only 15 harmonics are calculated, while others will be zeros.

PAS can give you indication on whether harmonic levels in the sampled waveforms exceed compliance limits defined by the power quality standards or local regulations.

To review or change harmonic limits:

1. Click on the spectrum window with the right mouse button and select "Limits..."
2. Select a harmonics standard, or select "Custom" and specify your own harmonic limits.

3. Check the Enabled box to visualize harmonic faults on the spectrum graph and in harmonic tables.

Harmonics that exceed selected compliance levels are colored in red on the graph and in the tables.

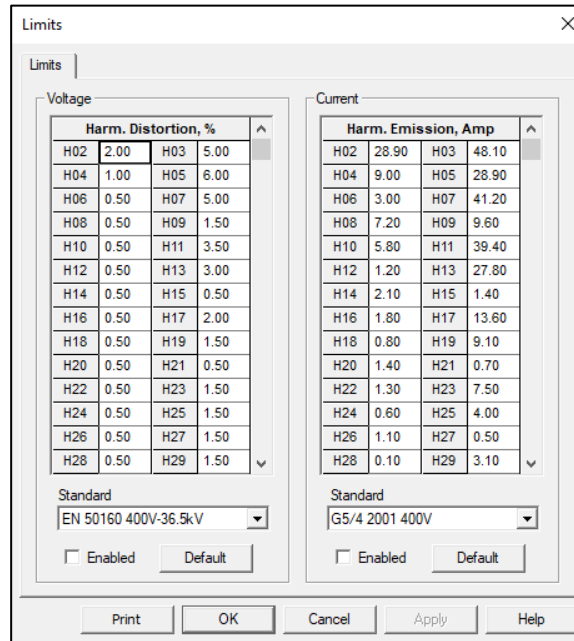

Viewing a Spectrum Table

Click on the button on the local toolbar to display the harmonics spectrum in a tabular view for a selected phase or for all phases together.

The spectrum table shows voltage, current, active power and reactive power harmonic components both in percent of the fundamental and in natural units, and harmonic phase angles.

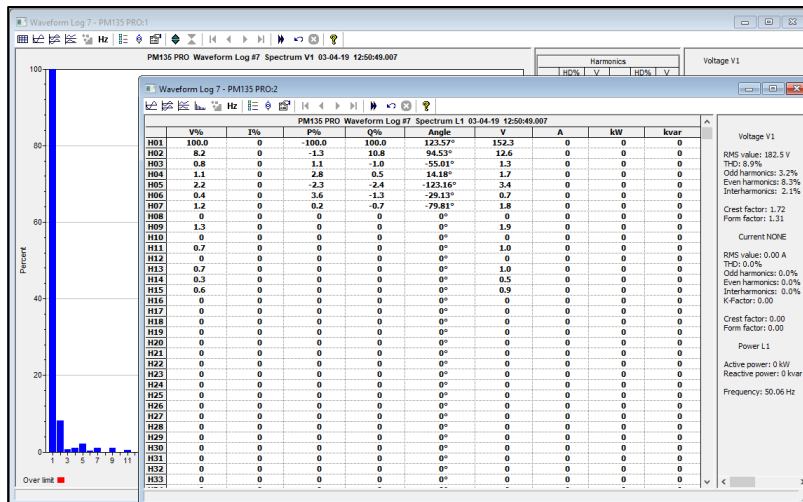

To change a phase, click on the window with the right mouse button, select "Options...", check the phase you want displayed, and then click OK.

Waveform Options

Scrolling through Waveforms

The status bar at the bottom of the window shows you how many records the log file contains. Use green arrowheads on the window toolbar to scroll through records.

Selecting Waveform Channels

A single waveform record may contain up to 33 waveforms including AC, digital and analog input channels, which can be displayed all together in a non-overlapped waveform view.

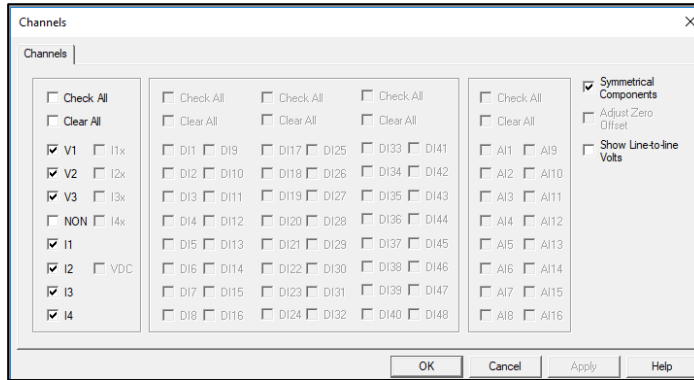

To select the channels you want to view on the screen, click on the waveform window with the right mouse button, select “Channels...”, check the channels you want displayed, and then click OK.

Checkboxes for channels that are not present in the waveform are dimmed.

Selecting the Time Axis

The horizontal axis can be displayed either in absolute time with date and time stamps, or in milliseconds relatively to the beginning of a waveform. To change the time units, click on the waveform window with the right mouse button, select “Options...”, click on the “Axes” tab, select the desired units, and then click OK.

Customizing Line Colors and Styles

Channel waveforms are displayed using different colors and line styles. To change the colors or line styles, click on the waveform window with the right mouse button, select “Options...”, click on the Display tab, adjust colors and styles, and then click OK. You can also change the waveform background and gridlines color.

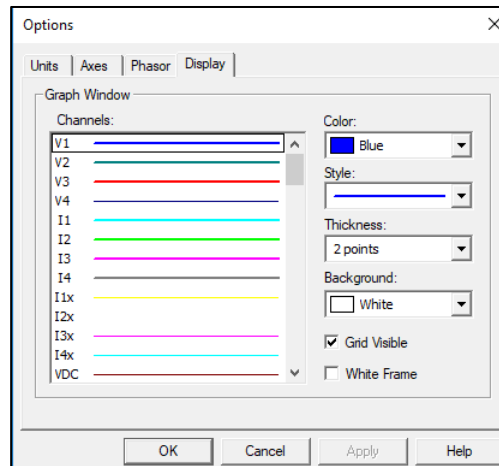

Viewing Phasor Diagrams

The phasor diagrams show you the relative magnitudes and angles of the three-phase voltage and current fundamental component. All angles are shown relative to the reference voltage channel.

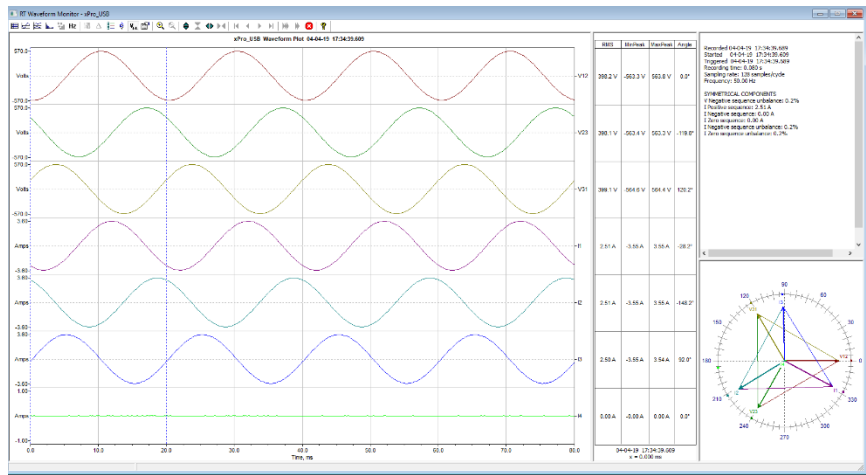

To change the reference channel, click on the waveform window with the right mouse button, select “Options...”, click on the “Phasor” tab, check the channel you want to make a reference channel, and then click “OK”.

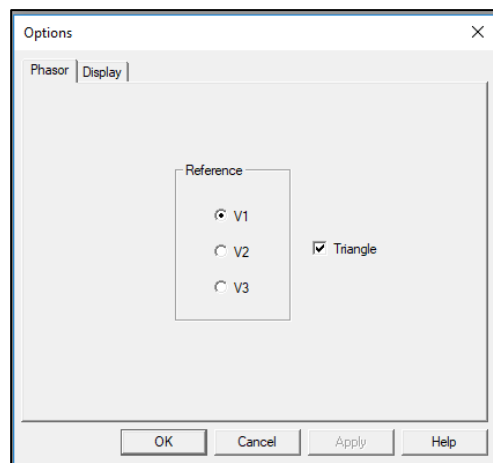

If you leave the Triangle box checked, PAS connects the ends of the voltage and current vectors showing you three-phase voltage and current unbalances.

Phasor diagrams are calculated over one waveform cycle pointed to by the left marker line. As you move the marker, the phasor diagrams are updated reflecting the new marker position.

Viewing Symmetrical Components

Waveform views have an additional pane at the right where PAS displays the symmetrical components for voltages and currents, calculated for the point indicated by the left marker line. To enable or disable the symmetrical components, click on the waveform window with the right mouse button, select “Options...”, check or uncheck the “Symmetrical components” box on the “Channels” tab, and then click OK.

Selecting Primary and Secondary Units

Voltages and currents can be displayed in primary or secondary units. To select units for your waveforms, click on the waveform window with the right mouse button, select “Options...”, select the desired units for voltages and currents on the Channels tab, and then click OK.



Using the Marker Lines

Waveform and RMS panes have two blue dashed marker lines. The left marker indicates the position from where data is taken to calculate the harmonics spectrum and phasor diagrams, and also as the starting position for calculating the RMS, average and peak values. The right marker indicates the end position for calculating the RMS, average and peak values. The minimum distance between the two markers is exactly one cycle.

To change the marker position, click on the  button, or click on the waveform window with the right

mouse button and select Set Marker, and then click on the point where you want to put the marker. You can drag both markers with the mouse, or use the right and left arrow keys on your keyboard to change the marker position. Click on the waveform pane to allow the keyboard to get your input before using the keyboard.

Using a Zoom

You can use a horizontal and a vertical zoom to change size of your waveforms. Use the buttons  on your local toolbar representing green arrowheads to zoom in or out of the waveform graph. Every click on these buttons gives you a 100-percent horizontal or 50-percent vertical zoom. Two buttons  give you a proportional zoom in both directions.

When in the overlapped waveform view, you can zoom in on a selected waveform region. Click on the waveform window with the right mouse button, click 'Zoom', point onto one of the corners of the region you want to zoom in, press and hold the left mouse button, then point to another corner of the selected region and release the mouse button.

Delta Measurements

To measure the distance between two waveform points, click on the Delta button , then click on one point, and then click on the second point. The first reference point is still frozen until you close and reopen Delta, while the second point can be placed anywhere within the waveform line. You can measure a delta in both directions. To disable the Delta, click on the Delta button once again.

Viewing Synchronized Waveforms

If you have a number of devices with synchronized clocks, you can view waveforms recorded at different locations in one window. PAS can synchronize the time axes for different waveforms so they could be displayed in a single plot.

To get synchronized waveforms:

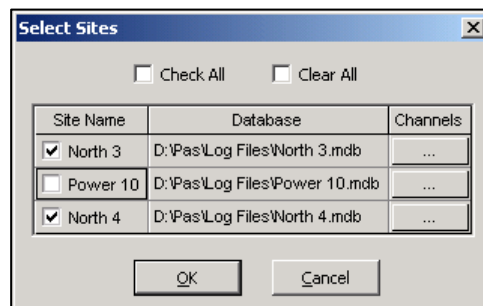

1. Put the databases with waveforms into the same folder, or put the sites from which you uploaded data to the same group in the sites tree.
2. Open a waveform you want to synchronize with other waveforms, and then click on the Multi-site View button . PAS searches for time-coordinated waveforms that have the same time span as your selected waveform.
3. Check the sites you want to see displayed.





4. Click on the "Channels" button and select channels for each site.
5. Click OK.

To change the channels, click on the waveform window with the right mouse button and select "Channels..."

Sometimes, it is useful to review a particular piece of historical data on-line at the time you expect new events to appear in the log. PAS allows you to retrieve historical data from a particular log without storing it to a file. The data appears only in the window on your screen. You can save it manually to the database.

To view the log data on-line, check the On-line button  on the PAS toolbar, select the log you want to retrieve in the Logs menu, and then click on the Poll button . Only new log records are retrieved from

the device. If you want to review the entire log from the beginning, click on the Restore log button , and then click on the Poll button .

NOTE

When reading multi-section profile data, only the first section is available for reading online.

See Chapter 9 [Viewing Files](#) for information on using different log views.

Exporting Files

Exporting Files in COMTRADE and PQDIF Formats

The COMTRADE and PQDIF file converters allow you to convert saved real-time waveforms into COMTRADE or PQDIF file format, and data log tables – into PQDIF format.

Manual Converting

To manually convert your waveforms or a data log into COMTRADE or PQDIF format:

1. Click on the Export  button on the PAS toolbar.

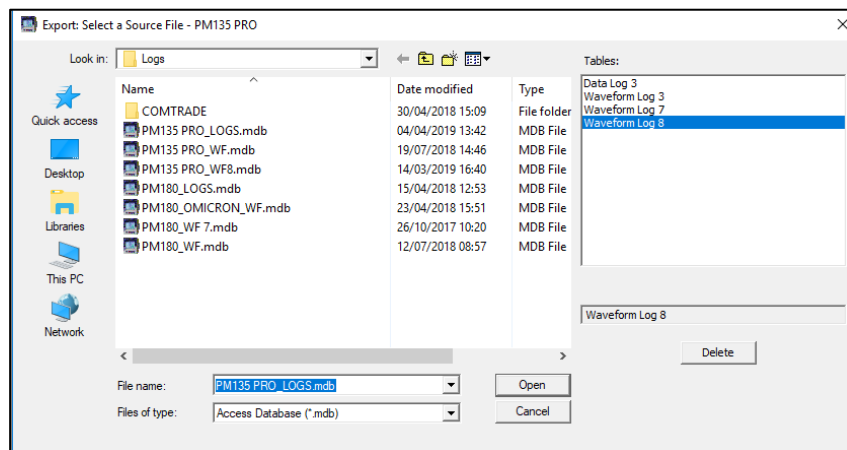

2. Select the database and a data log table you want to export, and then click Open.

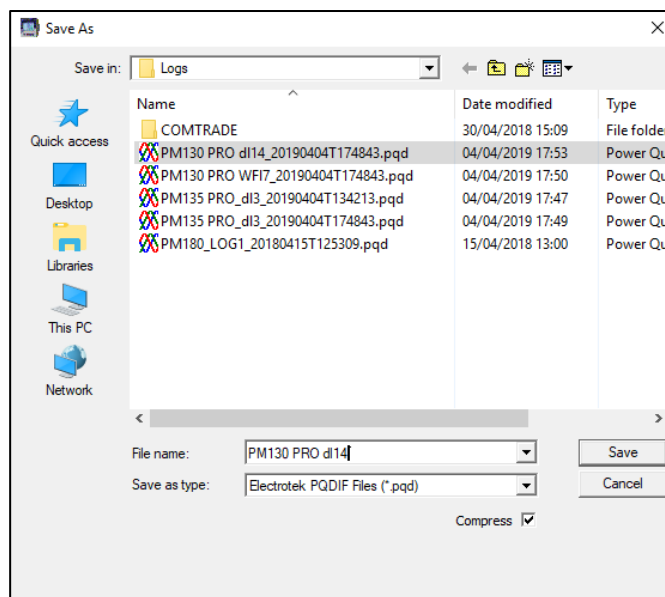

3. Select a folder where you want to store your exported files, type a file name that identifies your files, select a file output format, and then click on the Save button.

4. The PQDIF files are commonly recorded in compressed format. If you do not want your files to be compressed, uncheck the Compress box before saving the file.

In COMTRADE format, each waveform event is recorded into a separate file.

PQDIF file names are followed by a timestamp of the first event recorded to the file, and may look like follows:

PM130 PRO dl14_20190404T174843.pqd.

Automatic Converting

PAS allows you to automatically convert data logs into PQDIF format at the time you upload data from your devices via the Upload Scheduler.

To automatically convert your data log tables into PQDIF format:

2. Open the Upload Scheduler.
3. Highlight a desired device site with the left mouse button, and then click on the Export button.
4. Check the Enabled box for a data log or a waveform log table you want to automatically convert at the upload time.
5. Highlight the Record to... row for the selected table and click on the Browse button.
6. Select a folder where you want to store converted files, type in the converted file's name, select a desired output file format, and then click on Save.
7. Repeat the same for all tables you wish to be converted.
8. Click OK.

Exporting Files in Excel Format

PAS allows you to convert data tables into the Microsoft Excel workbook format, either manually, or automatically while retrieving data from your meters via the Upload Scheduler.

To store files in Excel format, follow instructions in the previous section and select Excel Workbook as the output file format.

The first row of the Excel table lists data names and the second row provides data codes, which identify recorded data points (see Modbus communications guide for data codes) that may be useful for automated table processing.

Each table row is provided with the device identifier that you can define in the meter database.

Archiving Files

Microsoft Access databases tend to grow fast. Databases above 0.5 Gigabytes can drastically slow down file operations.

To avoid enormous growing files, you can either periodically change the target database, or use the Upload Scheduler's file archiver to automatically move older data to archives.

The Upload Scheduler archives files upon a weekly, monthly or yearly schedule. When archiving data, a new database is created to where older data from your present database with the expired archiving date is moved.

An archive file keeps the original database name to which the date of the oldest database record is added, so you can easily identify your archives and work with them as you work with a regular database.

To provide a schedule for archiving files:

1. When defining a schedule for uploading files from your meter, click on Configure or double click on the site row.
2. Click Auto Archive.

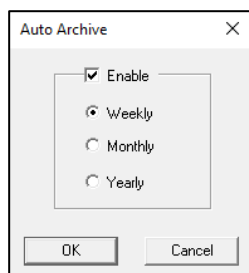

3. Check the Enable box and select a periodic schedule for archiving your files for this site.
4. Click OK.

To avoid archiving partially updated data, archiving is performed in a day after expiring a scheduled period and not before 2 hours a.m.

Chapter 14 Technical Specifications

Environmental Conditions

Rated temperature range: with specified uncertainty: -25°C to +55°C (-13°F to 131°F)
Limited Operating temperature range: no Hardware failures: -40°C to +70°C (-40°F to 158°F)
Display limited Operating temperature range: -20°C to +70°C (-4°F to 158°F)
Limited Storage temperature: -30°C to 85°C (-40°F to 185°F)
Altitude: up to 2000m (>6561ft) above sea level
Humidity: 0 to 95% non-condensing
Degree of protection: IP51

Construction

Dimensions see [Figure 2-1](#)
Weight: 0.70 kg (1.54 lb.)
Materials
Case enclosure: plastic PC/ABS blend
Front panel: plastic PC
PCB: FR4 (UL94-V0)
Terminals: PBT (UL94-V0)
Connectors-Plug-in type: Polyamide PA6.6 (UL94-V0)
Packaging case: Carton and Stratocell® (Polyethylene Foam) brackets
Labels: Polyester film (UL94-V0)

Power Supply Installation Category III

Rated input: 100-277 V AC @ 50/60 Hz, 40-290VDC (voltage is presented as nominal value, admissible tolerance of $\pm 15\%$ from mains), Burden 11VA
Isolation: 4000VAC @ 1mn
Wire size: up to 10 AWG (> 4.5 mm²)

Input Ratings

Voltage input rating L-N (L-L) Measurement CAT III

Operating range: 5 VAC (L-N)/ 8VAC (L-L) to 690 VAC (L-N)/ 1000 VAC (L-L)¹
Input impedance: 4000 k Ω
Burden for 400V: < 0.04 VA
Burden for 120V: < 0.01VA
Over-voltage withstands: 1000 VAC continuous, 2000 VAC for 1 second
Isolation: 4000VAC @ 1mn
Wire size: up to 10 AWG (> 4.5 mm²)
¹_UL Listing covers the nominal Voltage Input up to 277V L-N (480V L-L)

Current Inputs (via CT) – Measurement CAT III

Wire size: up to 10 AWG (> 4.5 mm²)
Galvanic isolation: 4000VAC @ 1mn
1A or 5A rating from CT secondary (standard)
Operating range: continuous 2A RMS (I_n=1A) or 10A (I_n=5A) RMS
Burden: < 0.2 VA @ I_n=1A-5A
Overload withstands:
15A RMS continuous, 200A (20 x I_{max}) RMS for ½ second (with 10AWG section wire)

20mA secondary via External Solid or Split core CT (HACS option)
External CT Operating range: continuous 100-3000A RMS (primary current)
Burden: < 0.02 VA @ nominal current
Sampling Rate measurement

Optional Relay Outputs

Built-in option

Solid State relay option
1 relays rated at 50mA/250 V AC/DC, 1 contact (SPST Form A, Resistive load)
Galvanic isolation: 4000VAC @ 1mn
Operate time: 1 ms max.
Release time: 0.25 ms max.
Update time: 1 cycle
Connector type: removable, 2 pins.
Wire size: 14 AWG (up to 1.5 mm²)

4RO optional module

- Electromechanical relay - DRY contact (option1)
4 relays rated at 5A/250 VAC; 5A/30 VDC, 1 contact (SPST Form A)
Galvanic isolation:
Between contacts and coil: 3000VAC @ 1mn
Between open contacts: 750 VAC
Operate time: 10 ms max.
Release time: 5 ms max.
Wire size: 14 AWG (up to 1.5 mm²)
- Solid state relay - DRY contact (option2)
4 relays rated at 100mA/250 VAC/VDC, 1 contact (SPST Form A)
Galvanic isolation:
Between contacts and coil: 5000VAC @ 1mn
Between open contacts: 800V peak
Operate time: 5 ms max.
Release time: 5 ms max.
Wire size: 14 AWG (up to 1.5 mm²)
Update time: 1 cycle
Wire size: 14 AWG (up to 1.5 mm²)

Optional Digital Inputs

Built-in (optional)

2 digital inputs
Dry Contacts, internally wetted @ 24VDC

Galvanic isolation: 4000VAC @ 1mn
Internal power supply: 24VDC
Scan time: 1 ms
Connector type: removable, 5 pins.
Wire size: 14 AWG (up to 1.5 mm²)

8DI optional module

4 or 8 Digital Inputs (4DI/2DO, 8DI Optional module)
Dry Contacts, internally wetted @ 24VDC
Wet contact @ 250VDC (8DIonly)
Sensitivity: Open @ input resistance >100 k Ω , Closed @ Input resistance < 100 Ω
Galvanic isolation: 4000VAC @ 1mn
Internal power supply: 24VDC
Scan time: 1 ms
Connector type: removable, 2 x 5 pins.
Wire size: 14 AWG (up to 1.5 mm²)

Communication Ports

COM1

RS-485 optically isolated port
Isolation: 4000VAC @ 1mn
Baud rate: up to 115.2 kbps.
Supported protocols: MODBUS RTU, DNP3, SATEC ASCII, IEC 60870-5-101
Connector type: removable, 3 pins.
Wire size: up to 14 AWG (up to 1.5 mm²).

COM2 (Optional module)

RS-485 optically isolated port
Isolation: 4000VAC @ 1mn
Baud rate: up to 115.2 kbps.
Supported protocols: MODBUS RTU, DNP3, SATEC ASCII, IEC 60870-5-101
Connector type: removable, 3 pins.
Wire size: up to 14 AWG (up to 1.5 mm²).

COM4

Infra Red COM port
Isolation: 4000VAC @ 1mn
Baud rate: up to 38.4 kbps.
Supported protocols: MODBUS RTU, IEC 62056-21 (future)
Front Panel access with magnetic head

Ethernet Port (2 x ports)

Transformer-isolated 10/100BaseT Ethernet port
Supported protocols: MODBUS/TCP (Port 502), DNP3/TCP (Port 20000), IEC 60870-5-104, IEC 61850
Number of simultaneous connections: 10 (5 MODBUS/TCP + 5 DNP3/TCP).
Isolation: 4000VAC @ 1mn

Connector type: RJ45 modular.

Real-time Clock

Standard Meter Clock (PM335 PRO regular version)

Battery backup clock

Accuracy: typical error 15 seconds per month/ < 5 minutes/year @ 25°C

Typical clock retention time: 24 months

Display

PM335

3.5" LCD TFT color Display, 320 x 480 dots resolution

Tri-color LED load bar graph (40-110%)

Diagnostics indication LED

kWh/kvarh Pulse LED

Keypad: 5 push buttons

EM235

1.77" LCD TFT color Display, 120 x 160 dots resolution

Diagnostics indication LED

kWh/kvarh Pulse LED

Keypad: 4 push buttons

Standards Compliance

Accuracy:

Meets IEC62053-22:2003, class 0.2S

Meets IEC 62053-24:2014, class 0.2S

Meets ANSI C12.20 –2015, class 10 0.2%

Electromagnetic Immunity:

Comply with IEC 61000-6-2:

IEC 61000-4-2 level 3: Electrostatic Discharge

IEC 61000-4-3 level 3: Radiated Electromagnetic RF Fields

IEC 61000-4-4 level 3: Electric Fast Transient

IEC 61000-4-5 level 3: Surge

IEC 61000-4-6 level 3: Conducted Radio Frequency

IEC 61000-4-8: Power Frequency Magnetic Field

Meets ANSI/IEEE C37.90.1: Fast Transient SWC

Electromagnetic Emission:

Complies with IEC 61000-6-4: Radiated/Conducted class B

Complies with IEC CISPR 22: Radiated/Conducted class B

Safety/Construction:

Meets IEC/UL 61010-1, 3rd ed.

AC and Impulse Insulation:

Meets IEC 62052-11:

4000 VAC during 1 minute

6KV/500Ω @ 1.2/50 μs impulse

Degree of Protection: IP51

UL Listing covers the base unit, the optional modules are not a part of UL listing

Measurement Specifications

Table 22: Measurement Specifications Parameters

Parameter	Full Scale @ Input Range	Accuracy			Range
		% Reading	% FS	Conditions	
Voltage	120V×PT @ 120V 400V×PT @ 690V	0.1	0.02	10% to 120% FS	0 to 1,150,000 V Starting voltage 1.5-5.0% FS (selectable)
Line current	CT	0.1	0.02	For In = 5A 1% to 200% FS For In = 1A 5% to 200% FS	0 to 50,000 A Starting current 0.1% FS
Active power	0.36×PT×CT @ 120V 1.2×PT×CT @ 690V	0.2	0.02	PF ≥ 0.5	-10,000,000 kW to +10,000,000 kW
Reactive power	0.36×PT×CT @ 120V 1.2×PT×CT @ 690V	0.2	0.04	PF ≤ 0.9 ¹	-10,000,000 kvar to +10,000,000 kvar
Apparent power	0.36×PT×CT @ 120V 1.2×PT×CT @ 690V	0.2	0.02	PF ≥ 0.5 ¹	0 to 10,000,000 kVA
Power factor	1.000		0.2	PF ≥ 0.5, I ≥ 2% FSI	-0.999 to +1.000
Frequency		0.002		VL-N > 25V	40 Hz to 70 Hz
Total Harmonic Distortion, THD V (I), %V _f (%I _f)	999.9	1.5	0.2	THD ≥ 1%, V ≥ 10% FSV and VL-N > 25V, I ≥ 10% FSI	0 to 999.9
Total Demand Distortion, TDD, %	100		1.5	TDD ≥ 1%, I ≥ 10% FSI, VL-N > 25V	0 to 100
Active energy Import & Export		Class 0.2S under conditions as per IEC 62053-22:2003			0 to 999,999,999 kWh
Reactive energy Import & Export		Class 0.5S under conditions as per IEC 62053-24:2015			0 to 999,999,999 kvarh
Apparent energy		Class 0.2S under conditions as per IEC 62053-22:2003			0 to 999,999,999 kVAh

PT - external potential transformer ratio

CT - primary current rating of the external current transformer

FSV - voltage full scale

FSI - current full scale

V_f - fundamental voltageI_f - fundamental current

NOTES

- Accuracy is expressed as ± (percentage of reading + percentage of full scale) ± 1 digit. This does not include inaccuracies introduced by the user's potential and current transformers. Accuracy calculated at 1second average.
- Specifications assume: voltage and current waveforms with THD ≤ 5% for kvar, kVA and PF, and reference

- operating temperature 20°C - 26°C.
3. Measurement error is typically less than the maximum error indicated.

Chapter 15 Analog Output Parameters

The following table lists parameters that can be provided on the meter's analog outputs.

Table 23: Analog Output Parameters

Display Code	Designation	Description
none	NONE	None (output disabled)
		1-Cycle Phase Values
rt.U1	V1/12 RT ¹	V1/V12 Voltage
rt.U2	V2/23 RT ¹	V2/V23 Voltage
rt.U3	V3/31 RT ¹	V3/V31 Voltage
rt.U12	V12 RT	V12 Voltage
rt.U23	V23 RT	V23 Voltage
rt.U31	V31 RT	V31 Voltage
rt.C1	I1 RT	I1 Current
rt.C2	I2 RT	I2 Current
rt.C3	I3 RT	I3 Current
		1-Cycle Total Values
rt. P	kW RT	Total kW
rt. q	kvar RT	Total kvar
rt. S	kVA RT	Total kVA
rt. PF	PF RT	Total PF
r.PF.LG	PF LAG RT	Total PF Lag
r.PF.Ld	PF LEAD RT	Total PF Lead
		1-Cycle Auxiliary Values
r.nEU.C	In RT	In Current
rt. Fr	FREQ RT	Frequency
		1-Sec Phase Values
Ar.U1	V1/12 AVR ¹	V1/V12 Voltage
Ar.U2	V2/23 AVR ¹	V2/V23 Voltage
Ar.U3	V3/31 AVR ¹	V3/V31 Voltage
Ar.U12	V12 AVR	V12 Voltage
Ar.U23	V23 AVR	V23 Voltage
Ar.U31	V31 AVR	V31 Voltage
Ar.C1	I1 AVR	I1 Current
Ar.C2	I2 AVR	I2 Current
Ar.C3	I3 AVR	I3 Current
		1-Sec Total Values
Ar. P	kW AVR	Total kW
Ar. q	kvar AVR	Total kvar
Ar. S	kVA AVR	Total kVA
Ar. PF	PF AVR	Total PF
A.PF.LG	PF LAG AVR	Total PF Lag
A.PF.Ld	PF LEAD AVR	Total PF Lead
		1-Sec Auxiliary Values
A.nEU.C	In AVR	In Current
Ar. Fr	FREQ AVR	Frequency
		Demands E, EH
Acd.P.i	kW IMP ACD	Accumulated kW import demand
Acd.P.E	kW EXP ACD	Accumulated kW export demand
Acd.q.i	kvar IMP ACD	Accumulated kvar import demand
Acd.q.E	kvar EXP ACD	Accumulated kvar export demand

Display Code	Designation	Description
Acc.S	kVA ACD	Accumulated kVA demand

¹ In 4LN3, 3LN3 and 3BLN3 wiring modes, the voltages will be line-to-neutral; for any other wiring mode, they will be line-to-line voltages.

Chapter 16 Setpoint Triggers and Actions

Table 24: Setpoint Triggers

Display Code	Designation	Description
None	NONE	None (condition is not active)
		Status Inputs
DI1 On	STAT INP #1 ON	Status input #1 ON
DI2 On	STAT INP #2 ON	Status input #2 ON
DI3 On	STAT INP #3 ON	Status input #3 ON
DI4 On	STAT INP #4 ON	Status input #4 ON
DI5 On	STAT INP #5 ON	Status input #5 ON
DI6 On	STAT INP #6 ON	Status input #6 ON
DI7 On	STAT INP #7 ON	Status input #7 ON
DI8 On	STAT INP #8 ON	Status input #8 ON
DI9 On	STAT INP #9 ON	Status input #9 ON
DI10 On	STAT INP #10 ON	Status input #10 ON
DI11 On	STAT INP #11 ON	Status input #11 ON
DI12 On	STAT INP #12 ON	Status input #12 ON
DI1 OFF	STAT INP #1 OFF	Status input #1 OFF
DI2 OFF	STAT INP #2 OFF	Status input #2 OFF
DI3 OFF	STAT INP #3 OFF	Status input #3 OFF
DI4 OFF	STAT INP #4 OFF	Status input #4 OFF
DI5 OFF	STAT INP #5 OFF	Status input #5 OFF
DI6 OFF	STAT INP #6 OFF	Status input #6 OFF
DI7 OFF	STAT INP #7 OFF	Status input #7 OFF
DI8 OFF	STAT INP #8 OFF	Status input #8 OFF
DI9 OFF	STAT INP #9 OFF	Status input #9 OFF
DI10 OFF	STAT INP #10 OFF	Status input #10 OFF
DI11 OFF	STAT INP #11 OFF	Status input #11 OFF
DI12 OFF	STAT INP #12 OFF	Status input #12 OFF
		Relays
RO1 ON	RELAY #1 ON	Relay #1 ON
RO2 ON	RELAY #2 ON	Relay #2 ON
RO3 ON	RELAY #3 ON	Relay #3 ON
RO4 ON	RELAY #4 ON	Relay #4 ON
RO1 OFF	RELAY #1 OFF	Relay #1 OFF
RO2 OFF	RELAY #2 OFF	Relay #2 OFF
RO3 OFF	RELAY #3 OFF	Relay #3 OFF
RO4 OFF	RELAY #4 OFF	Relay #4 OFF
		Phase Reversal
Pos Phase Reversal	POS PHASE REVERSAL	Positive phase rotation reversal
Neg Phase Reversal	NEG PHASE REVERSAL	Negative phase rotation reversal
		Low/High 1-Cycle Values on any Phase
High Volt RT	HI VOLT RT ¹	High voltage
Low Volt RT	LO VOLT RT ¹	Low voltage
High Amps RT	HI AMPS RT	High current
Low Amps RT	LO AMPS RT	Low current
High Volt THD RT	HI V THD ²	High voltage THD
High Current THD RT	HI I THD ²	High current THD
High KF RT	HI KF RT	High K-Factor
High Current TDD RT	HI I TDD	High current TDD

Display Code	Designation	Description
		1-Cycle Auxiliary Values
High Freq RT	HI FREQ RT	High frequency
Low Freq RT	LO FREQ RT	Low frequency
High Volt Unb% RT	HI V UNB% RT ¹	High voltage unbalance
High Curr Unb% RT	HI I UNB% RT	High current unbalance
		1-Sec Phase Values
High I1 Avr	HI I1 AVR	High I1 current
High I2 Avr	HI I2 AVR	High I2 current
High I3 Avr	HI I3 AVR	High I3 current
Low I1 Avr	LO I1 AVR	Low I1 current
Low I2 Avr	LO I2 AVR	Low I2 current
Low I3 Avr	LO I3 AVR	Low I3 current
		1-Sec Values on any Phase
High Volt Avr	HI VOLT AVR ¹	High voltage
Low Volt Avr	LO VOLT AVR ¹	Low voltage
High Amps Avr	HI AMPS AVR	High current
Low Amps Avr	LO AMPS AVR	Low current
		1-Sec Total Values
High kW Imp Avr	HI kW IMP AVR	High total kW import
High kW Exp Avr	HI kW EXP AVR	High total kW export
High kvar Imp Avr	HI kvar IMP AVR	High total kvar import
High kvar Exp Avr	HI kvar EXP AVR	High total kvar export
High kVA Avr	HI kVA AVR	High total kVA
Low PF Lag Avr	HI PF LAG AVR	Low total PF Lag
Low PF Lead Avr	HI PF LEAD AVR	Low total PF Lead
		1-Sec Auxiliary Values
High In Avr	HI In AVR	High neutral current
High Freq Avr	HI FREQ RT	High frequency
Low Freq Avr	LO FREQ RT	Low frequency
		Demands
High V1/12 Dmd	HI V1/12 DMD ¹	High V1/V12 Volt demand
High V2/23 Dmd	HI V2/23 DMD ¹	High V2/V23 Volt demand
High V3/31 Dmd	HI V3/31 DMD ¹	High V3/V31 Volt demand
High I1 Dmd	HI I1 DMD	High I1 Ampere demand
High I2 Dmd	HI I2 DMD	High I2 Ampere demand
High I3 Dmd	HI I3 DMD	High I3 Ampere demand
High kW Imp BD	HI kW IMP BD	High block kW import demand
High kVA BD	HI kVA BD	High block kVA demand
High kW Imp SD	HI kW IMP SD	High sliding window kW import demand
High kVA SD	HI kVA SD	High sliding window kVA demand
High kW Imp Acc Dmd	HI kW IMP ACD	High accumulated kW import demand
High kVA Imp Acc Dmd	HI kVA ACD	High accumulated kVA demand
High kW Imp Prd Dmd	HI kW IMP PRD	High predicted kW import demand
High kVA Imp Prd Dmd	HI kVA PRD	High predicted kVA demand
		Time and Date Parameters
Day of Week	DAY OF WEEK	Day of week
Year	YEAR	Year
Monh	MONTH	Month
Day of Month	DAY OF MONTH	Day of month
Hours	HOURS	Hours
Minutes	MINUTES	Minutes
Seconds	SECONDS	Seconds

Display Code	Designation	Description
Minute Interval	MINUTE INTERVAL	Minute interval: 1-5, 10, 15, 20, 30, 60 min

¹ In 4LN3, 3LN3 and 3BLN3 wiring modes, the voltages will be line-to-neutral; for any other wiring mode, they will be line-to-line voltages.

Table 25: Setpoint Actions

Display Code	Designation	Description
None	NONE	None (no action)
Relay 1 ON	OPERATE RELAY #1	Operate relay RO1
Relay 2 ON	OPERATE RELAY #2	Operate relay RO2
Relay 3 ON	OPERATE RELAY #3	Operate relay RO3
Relay 4 ON	OPERATE RELAY #4	Operate relay RO4
Relay 1 OFF	RELEASE RELAY #1	Release latched relay RO1
Relay 2 OFF	RELEASE RELAY #2	Release latched relay RO2
Relay 3 OFF	RELEASE RELAY #3	Release latched relay RO3
Relay 4 OFF	RELEASE RELAY #4	Release latched relay RO4
Increment counter 1	INC CNT #1	Increment counter #1
Increment counter 2	INC CNT #2	Increment counter #2
Increment counter 3	INC CNT #3	Increment counter #3
Increment counter 4	INC CNT #4	Increment counter #4
Time counter 1	TIME CNT #1	Count operation time using counter #1
Time counter 2	TIME CNT #2	Count operation time using counter #2
Time counter 3	TIME CNT #3	Count operation time using counter #3
Time counter 4	TIME CNT #4	Count operation time using counter #4
Notification	NOTIFICATION	Send a notification message
Data Log 1	DATA LOG #1	Record data to Data Log #1

Chapter 17 Parameters for Data Monitoring and Logging

The following table lists parameters measured by the meter that are available for monitoring through communications and for recording to a appendix. The left column shows data abbreviations used in PAS. Parameter groups are highlighted in bold.

Table 26: Data Monitoring and Logging Parameters

Designation	Description
NONE	None (stub, read as zero)
DIGITAL INPUTS	Digital Inputs
DI1:16	Digital Inputs Status DI1:DI12
RELAYS	Relays
RO1:16	Relay Status RO1:RO4
COUNTERS	Pulse Counters
COUNTER 1	Counter #1
COUNTER 2	Counter #2
COUNTER 3	Counter #3
COUNTER 4	Counter #4
RT PHASE	1-Cycle Phase Values
V1	V1/V12 Voltage ¹
V2	V2/V23 Voltage ¹
V3	V3/V31 Voltage ¹
I1	I1 Current
I2	I2 Current
I3	I3 Current
kW L1	kW L1
kW L2	kW L2
kW L3	kW L3
kvar L1	kvar L1
kvar L2	kvar L2
kvar L3	kvar L3
kVA L1	kVA L1
kVA L2	kVA L2
kVA L3	kVA L3
PF L1	Power factor L1
PF L2	Power factor L2
PF L3	Power factor L3
V1 THD	V1/V12 Voltage THD ¹
V2 THD	V2/V23 Voltage THD ¹
V3 THD	V3/V31 Voltage THD ¹
I1 THD	I1 Current THD
I2 THD	I2 Current THD
I3 THD	I3 Current THD
I1 KF	I1 K-Factor
I2 KF	I2 K-Factor
I3 KF	I3 K-Factor
I1 TDD	I1 Current TDD
I2 TDD	I2 Current TDD
I3 TDD	I3 Current TDD
V12	V12 Voltage
V23	V23 Voltage

Designation	Description
V31	V31 Voltage
RT TOTAL	1-Cycle Total Values
kW	Total kW
kvar	Total kvar
kVA	Total kVA
PF	Total PF
PF LAG	Total PF lag
PF LEAD	Total PF lead
kW IMP	Total kW import
kW EXP	Total kW export
kvar IMP	Total kvar import
kvar EXP	Total kvar export
V AVG	3-phase average L-N/L-L voltage
V LL AVG	3-phase average L-L voltage
I AVG	3-phase average current
RT AUX	1-Cycle Auxiliary Values
In	In (neutral) Current
FREQ	Frequency
V UNB%	Voltage unbalance ²
I UNB%	Current unbalance ²
AVR PHASE	1-Second Phase Values
V1	V1/V12 Voltage
V2	V2/V23 Voltage
V3	V3/V31 Voltage
I1	I1 Current
I2	I2 Current
I3	I3 Current
kW L1	kW L1
kW L2	kW L2
kW L3	kW L3
kvar L1	kvar L1
kvar L2	kvar L2
kvar L3	kvar L3
kVA L1	kVA L1
kVA L2	kVA L2
kVA L3	kVA L3
PF L1	Power factor L1
PF L2	Power factor L2
PF L3	Power factor L3
V1 THD	V1/V12 Voltage THD ¹
V2 THD	V2/V23 Voltage THD ¹
V3 THD	V3/V31 Voltage THD ¹
I1 THD	I1 Current THD
I2 THD	I2 Current THD
I3 THD	I3 Current THD
I1 KF	I1 K-Factor
I2 KF	I2 K-Factor
I3 KF	I3 K-Factor
I1 TDD	I1 Current TDD
I2 TDD	I2 Current TDD
I3 TDD	I3 Current TDD
V12	V12 Voltage

Designation	Description
V23	V23 Voltage
V31	V31 Voltage
AVR TOTAL	1-Second Total Values
kW	Total kW
kvar	Total kvar
kVA	Total kVA
PF	Total PF
PF LAG	Total PF lag
PF LEAD	Total PF lead
kW IMP	Total kW import
kW EXP	Total kW export
kvar IMP	Total kvar import
kvar EXP	Total kvar export
V AVG	3-phase average L-N/L-L voltage ¹
V LL AVG	3-phase average L-L voltage
I AVG	3-phase average current
AVR AUX	1-Second Auxiliary Values
In	In (neutral) Current
FREQ	Frequency
V UNB%	Voltage unbalance ²
I UNB%	Current unbalance ²
PHASORS	Phasors
V1 Mag	V1/V12 Voltage magnitude ¹
V2 Mag	V2/V23 Voltage magnitude ¹
V3 Mag	V3/V31 Voltage magnitude ¹
I1 Mag	I1 Current magnitude
I2 Mag	I2 Current magnitude
I3 Mag	I3 Current magnitude
V1 Ang	V1/V12 Voltage angle ¹
V2 Ang	V2/V23 Voltage angle ¹
V3 Ang	V3/V31 Voltage angle ¹
I1 Ang	I1 Current angle
I2 Ang	I2 Current angle
I3 Ang	I3 Current angle
DEMANDS	Present Demands (Power Demands E, EH)
V1 DMD	V1/V12 Volt demand ¹
V2 DMD	V2/V23 Volt demand ¹
V3 DMD	V3/V31 Volt demand ¹
I1 DMD	I1 Ampere demand
I2 DMD	I2 Ampere demand
I3 DMD	I3 Ampere demand
kW IMP BD	kW import block demand
kvar IMP BD	kvar import block demand
kVA BD	kVA block demand
kW IMP SD	kW import sliding window demand
kvar IMP SD	kvar import sliding window demand
kVA SD	kVA sliding window demand
kW IMP ACD	kW import accumulated demand
kvar IMP ACD	kvar import accumulated demand
kVA ACD	kVA accumulated demand
kW IMP PRD	kW import predicted sliding window demand

Designation	Description
kvar IMP PRD	kvar import predicted sliding window demand
kVA PRD	kVA predicted sliding window demand
PF IMP@kVA DMD	PF (import) at Maximum kVA sliding window demand
kW EXP BD	kW export block demand
kvar EXP BD	kvar export block demand
kW EXP SD	kW export sliding window demand
kvar EXP SD	kvar export sliding window demand
kW EXP ACD	kW export accumulated demand
kvar EXP ACD	kvar export accumulated demand
kW EXP PRD	kW export predicted sliding window demand
kvar EXP PRD	kvar export predicted sliding window demand
In DMD	In (neutral) current demand
SUMM ACC DMD	Billing Summary (Total) Accumulated Demands ^{E, EH}
REG1 ACD	Register #1 accumulated demand
REG2 ACD	Register #2 accumulated demand
REG3 ACD	Register #3 accumulated demand
REG4 ACD	Register #4 accumulated demand
SUMM BLK DMD	Billing Summary (Total) Block Demands ^{E, EH}
REG1 BD	Register #1 block demand
REG2 BD	Register #2 block demand
REG3 BD	Register #3 block demand
REG4 BD	Register #4 block demand
SUMM SW DMD	Billing Summary (Total) Sliding Demands ^{E, EH}
REG1 SD	Register #1 sliding demand
REG2 SD	Register #2 sliding demand
REG3 SD	Register #3 sliding demand
REG4 SD	Register #4 sliding demand
ENERGY	Total Energy ^{E, EH}
kWh IMPORT	kWh import
kWh EXPORT	kWh export
kvarh IMPORT	kvarh import
kvarh EXPORT	kvarh export
kVAh TOTAL	kVAh total
SUMMARY REGS	Billing Summary (Total) Energy Registers ^{E, EH}
SUM REG1	Summary energy register #1
SUM REG2	Summary energy register #2
SUM REG3	Summary energy register #3
SUM REG4	Summary energy register #4
PHASE ENERGY	Phase Energy ^{E, EH}
kWh IMP L1	kWh import L1
kWh IMP L2	kWh import L2
kWh IMP L3	kWh import L3
kvarh IMP L1	kvarh import L1
kvarh IMP L2	kvarh import L2
kvarh IMP L3	kvarh import L3
kVAh L1	kVAh total L1
kVAh L2	kVAh total L2
kVAh L3	kVAh total L3
%HD V1	V1/V12 Harmonic Distortions ^{EH 1}
V1 %HD01	H01 Harmonic distortion
V1 %HD02	H02 Harmonic distortion
...	...

Designation	Description
V1 %HD40	H40 Harmonic distortion
%HD V2	V2/V23 Harmonic Distortions ^{EH 1}
V2 %HD01	H01 Harmonic distortion
V2 %HD02	H02 Harmonic distortion
...	...
V2 %HD40	H40 Harmonic distortion
%HD V3	V3/V31 Harmonic Distortions ^{EH 1}
V3 %HD01	H01 Harmonic distortion
V3 %HD02	H02 Harmonic distortion
...	...
V3 %HD40	H40 Harmonic distortion
%HD I1	I1 Harmonic Distortions ^{EH}
I1 %HD01	H01 Harmonic distortion
I1 %HD02	H02 Harmonic distortion
...	...
I1 %HD40	H40 Harmonic distortion
%HD I2	I2 Harmonic Distortions ^{EH}
I2 %HD01	H01 Harmonic distortion
I2 %HD02	H02 Harmonic distortion
...	...
I2 %HD40	H40 Harmonic distortion
%HD I3	I3 Harmonic Distortions ^{EH}
I3 %HD01	H01 Harmonic distortion
I3 %HD02	H02 Harmonic distortion
...	...
I3 %HD40	H40 Harmonic distortion
ANG V1	V1/V12 Harmonic Angles ^{EH 1}
V1 H01 ANG	H01 Harmonic angle
V1 H02 ANG	H02 Harmonic angle
...	...
V1 H40 ANG	H40 Harmonic angle
ANG V2	V2/V23 Harmonic Angles ^{EH 1}
V2 H01 ANG	H01 Harmonic angle
V2 H02 ANG	H02 Harmonic angle
...	...
V2 H40 ANG	H40 Harmonic angle
ANG V3	V3/V31 Harmonic Angles ^{EH 1}
V3 H01 ANG	H01 Harmonic angle
V3 H02 ANG	H02 Harmonic angle
...	...
V3 H40 ANG	H40 Harmonic angle
ANG I1	I1 Harmonic Angles ^{EH}
I1 H01 ANG	H01 Harmonic angle
I1 H02 ANG	H02 Harmonic angle
...	...
I1 H40 ANG	H40 Harmonic angle
ANG I2	I2 Harmonic Angles ^{EH}
I2 H01 ANG	H01 Harmonic angle
I2 H02 ANG	H02 Harmonic angle
...	...
I2 H40 ANG	H40 Harmonic angle
ANG I3	I3 Harmonic Angles ^{EH}

Designation	Description
I3 H01 ANG	H01 Harmonic angle
I3 H02 ANG	H02 Harmonic angle
...	...
I3 H40 ANG	H40 Harmonic angle
H1 PHASE	Fundamental (H01) Phase Values
V1 H01	V1/V12 Voltage ¹
V2 H01	V2/V23 Voltage ¹
V3 H01	V3/V31 Voltage ¹
I1 H01	I1 Current
I2 H01	I2 Current
I3 H01	I3 Current
kW L1 H01	kW L1
kW L2 H01	kW L2
kW L3 H01	kW L3
kvar L1 H01	kvar L1
kvar L2 H01	kvar L2
kvar L3 H01	kvar L3
kVA L1 H01	kVA L1
kVA L2 H01	kVA L2
kVA L3 H01	kVA L3
PF L1 H01	Power factor L1
PF L2 H01	Power factor L2
PF L3 H01	Power factor L3
HRM TOT POW	Fundamental and Harmonic Total Power Values
kW H01	Total fundamental kW
kvar H01	Total fundamental kvar
kVA H01	Total fundamental kVA
PF H01	Total fundamental PF
MIN PHASE	Minimum 1-Cycle Phase Values
V1 MIN	V1/V12 Voltage ¹
V2 MIN	V2/V23 Voltage ¹
V3 MIN	V3/V31 Voltage ¹
I1 MIN	I1 Current
I2 MIN	I2 Current
I3 MIN	I3 Current
MIN TOTAL	Minimum 1-Cycle Total Values
kW MIN	Total kW
kvar MIN	Total kvar
kVA MIN	Total kVA
PF MIN	Total PF
MIN AUX	Minimum 1-Cycle Auxiliary Values
In MIN	In Current
FREQ MIN	Frequency
MAX PHASE	Maximum 1-Cycle Phase Values
V1 MAX	V1/V12 Voltage ¹
V2 MAX	V2/V23 Voltage ¹
V3 MAX	V3/V31 Voltage ¹
I1 MAX	I1 Current
I2 MAX	I2 Current
I3 MAX	I3 Current
MAX TOTAL	Maximum 1-Cycle Total Values

Designation	Description
kW MAX	Total kW
kvar MAX	Total kvar
kVA MAX	Total kVA
PF MAX	Total PF
MAX AUX	Maximum 1-Cycle Auxiliary Values
In MAX	In Current
FREQ MAX	Frequency
MAX DMD	Maximum Demands (Power Demands E, EH)
V1 DMD MAX	V1/V12 Maximum volt demand ¹
V2 DMD MAX	V2/V23 Maximum volt demand ¹
V3 DMD MAX	V3/V31 Maximum volt demand ¹
I1 DMD MAX	I1 Maximum ampere demand
I2 DMD MAX	I2 Maximum ampere demand
I3 DMD MAX	I3 Maximum ampere demand
kW IMP SD MAX	Maximum kW import sliding window demand
kW EXP SD MAX	Maximum kvar import sliding window demand
kvar IMP SD MAX	Maximum kW export sliding window demand
kvar EXP SD MAX	Maximum kvar export sliding window demand
kVA SD MAX	Maximum kVA sliding window demand
In DMD MAX	In (neutral) current maximum demand
MAX SUMMARY DMD	Billing Summary (Total) Maximum Demands E, EH
REG1 MD	Summary register #1 maximum demand
REG2 MD	Summary register #2 maximum demand
REG3 MD	Summary register #3 maximum demand
REG4 MD	Summary register #4 maximum demand
AO RAW	Raw Analog Outputs (A/D Units)
AO1	Analog output AO1
AO2	Analog output AO2
AO3	Analog output AO3
AO4	Analog output AO4
TOU PRMS	TOU Parameters E, EH
ACTIVE TARIFF	Active TOU tariff
ACTIVE PROFILE	Active TOU profile
TOU REG1	Billing TOU Energy Register #1 E, EH
REG1 TRF1	Tariff #1 register
REG1 TRF2	Tariff #2 register
...	...
REG1 TRF8	Tariff #8 register
TOU REG2	Billing TOU Energy Register #2 E, EH
REG2 TRF1	Tariff #1 register
REG2 TRF2	Tariff #2 register
...	...
REG2 TRF8	Tariff #8 register
TOU REG3	Billing TOU Energy Register #3 E, EH
REG3 TRF1	Tariff #1 register
REG3 TRF2	Tariff #2 register
...	...
REG3 TRF8	Tariff #8 register
TOU REG4	Billing TOU Energy Register #4 E, EH
REG4 TRF1	Tariff #1 register
REG4 TRF2	Tariff #2 register
...	...

Designation	Description
REG4 TRF8	Tariff #8 register
TOU MAX DMD REG1	Billing TOU Maximum Demand Register #1 ^{E, EH}
REG1 TRF1 MD	Tariff #1 maximum demand
REG1 TRF2 MD	Tariff #2 maximum demand
...	...
REG1 TRF8 MD	Tariff #8 maximum demand
TOU MAX DMD REG2	Billing TOU Maximum Demand Register #2 ^{E, EH}
REG2 TRF1 MD	Tariff #1 maximum demand
REG2 TRF2 MD	Tariff #2 maximum demand
...	...
REG2 TRF8 MD	Tariff #8 maximum demand
TOU MAX DMD REG3	Billing TOU Maximum Demand Register #3 ^{E, EH}
REG3 TRF1 MD	Tariff #1 maximum demand
REG3 TRF2 MD	Tariff #2 maximum demand
...	...
REG3 TRF8 MD	Tariff #8 maximum demand
TOU MAX DMD REG4	Billing TOU Maximum Demand Register #4 ^{E, EH}
REG4 TRF1 MD	Tariff #1 maximum demand
REG4 TRF2 MD	Tariff #2 maximum demand
...	...
REG4 TRF8 MD	Tariff #8 maximum demand

¹ In 4LN3, 3LN3 and 3BLN3 wiring modes, the voltages will be line-to neutral; for any other wiring mode, they will be line-to-line voltages.

² The value is calculated as a relation of the maximum deviation of phase values from a 3-phase average value to a 3-phase average.

NOTE

Designations of some engineering demands and billing energy and demand registers are shown using a short name notation available in PAS V1.4. By default, PAS uses long names compatible with older versions of PAS. You can select a desired notation from the Tools/Options/Preferences tab.

PAS does not allow to store data in files using different data names. If you have a file uploaded with a previous version of PAS using long data names, either continue using long data names, or store data in a new file.

See table below for a list of parameters with short and long names.

Short Data Name	Long Data Name	Description
kW IMP ACD	kW IMP ACC DMD	Accumulated demand
kW IMP PRD	kW IMP PRD DMD	Predicted sliding window demand
PF IMP@kVA MD	PF IMP@kVA MXDMD	PF (import) at maximum kVA demand
REG1 ACD	SUM REG1 ACC DMD	Billing summary (total) register accumulated demand
REG1 BD	SUM REG1 BLK DMD	Billing summary (total) register block demand
REG1 SD	SUM REG1 SW DMD	Billing summary (total) register sliding demand
REG1	SUM REG1	Billing summary (total) energy register
REG1 MD	SUM REG1 DMD MAX	Billing summary (total) register maximum demand
REG1 TRF1	TOU REG1 TRF1	Billing tariff energy register
REG1 TRF1 MD	DMD1 TRF1 MAX	Billing tariff register maximum demand
TRF1	SEASON TRF1	Generic billing tariff energy register
TRF1 MD	SEASON TRF1	Generic billing tariff register maximum demand

Chapter 18 Billing/TOU Profile Log File

The following table shows the record structure for the daily billing data profile log file. The second column shows data abbreviations used in the PAS data log reports. Data log file sections are highlighted in bold.

Table 27: Daily Billing/TOU Profile Data Log (Data Log #16)

Field No.	Designation	Description
		Energy Register #1
1	REG1	Summary (total) energy reading
2	TRF1	Tariff #1 energy reading
3	TRF2	Tariff #2 energy reading
4	TRF3	Tariff #3 energy reading
5	TRF4	Tariff #4 energy reading
6	TRF5	Tariff #5 energy reading
7	TRF6	Tariff #6 energy reading
8	TRF7	Tariff #7 energy reading
9	TRF8	Tariff #8 energy reading
		...
		Energy Register #4
1	REG4	Summary (total) energy reading
2	TRF1	Tariff #1 energy reading
3	TRF2	Tariff #2 energy reading
4	TRF3	Tariff #3 energy reading
5	TRF4	Tariff #4 energy reading
6	TRF5	Tariff #5 energy reading
7	TRF6	Tariff #6 energy reading
8	TRF7	Tariff #7 energy reading
9	TRF8	Tariff #8 energy reading
		Daily Maximum Demand Register #1
1	REG1 MD	Summary (total) max. demand reading
2	TRF1 MD	Tariff #1 max. demand reading
3	TRF2 MD	Tariff #2 max. demand reading
4	TRF3 MD	Tariff #3 max. demand reading
5	TRF4 MD	Tariff #4 max. demand reading
6	TRF5 MD	Tariff #5 max. demand reading
7	TRF6 MD	Tariff #6 max. demand reading
8	TRF7 MD	Tariff #7 max. demand reading
9	TRF8 MD	Tariff #8 max. demand reading
		...
		Daily Maximum Demand Register #4
1	REG4 MD	Summary (total) max. demand reading
2	TRF1 MD	Tariff #1 max. demand reading
3	TRF2 MD	Tariff #2 max. demand reading
4	TRF3 MD	Tariff #3 max. demand reading
5	TRF4 MD	Tariff #4 max. demand reading
6	TRF5 MD	Tariff #5 max. demand reading
7	TRF6 MD	Tariff #6 max. demand reading
8	TRF7 MD	Tariff #7 max. demand reading
9	TRF8 MD	Tariff #8 max. demand reading

The number of parameters in each section is automatically configured depending on the number of actual tariffs you defined in the TOU Daily Profiles.

Chapter 19 Data Scales

The maximum values for volts, amps and power in the PM335 PRO setup and in communications are limited by the voltage and current scale settings. See [Device Options](#) in Chapter 4 on how to change the voltage and current scales in your meter.

The following table shows the meter data scales.

Table 28: Data Scales Values

Scale	Conditions	Range
Maximum voltage (V max)	All configurations	Voltage scale \times PT Ratio, V ¹
Maximum current (I max)	All configurations	Current scale \times CT Ratio, A ^{2, 3}
Maximum Power ⁴	Wiring 4LN3, 3LN3, 3BLN3	V max \times I max \times 3, W
	Wiring 4LL3, 3LL3, 3BLL3, 3OP2, 3OP3, 3DIR2	V max \times I max \times 2, W
Maximum frequency	25, 50 or 60 Hz	100 Hz
	400Hz	500 Hz

¹ The default voltage scale is 144V. The recommended voltage scale is 120V+20% = 144V for using with external PT's, and 690V+20% = 828V for a direct connection to power line.

² CT Ratio = CT primary current/CT secondary current

³ The default current scale is 2 \times CT secondary (2.0A with 1A secondary and 10.0A with 5A secondary).

⁴ Maximum power is rounded to whole kilowatts. With PT=1.0, it is limited to 9,999,000 W.

Chapter 20 Device Diagnostic Codes

Table 29: Device Diagnostic Codes

Diagnostic Display	Diagnostic Message	Description	Reason
RAM/DATA fault	RAM/DATA Fault	Memory/Data fault	Hardware failure
HW watchdog reset	HW Watchdog Reset	Hardware watchdog reset	Hardware failure
CPU exception	CPU Exception	CPU exception	Hardware failure
Run-time error	Run-time Error	Run-time software error	Hardware failure
SW watchdog reset	SW Watchdog Reset	Software watchdog timeout	Hardware failure
Power down/Up	Power Down	Power Down/Up	Normal power-up sequence
External restart	Device Reset	Warm restart	External restart via communications or by firmware upgrade
Configuration reset	Configuration Reset	Configuration reset	Corrupted setup data has been replaced with the default configuration
RTC fault	RTC Fault	RTC fault	The clock time has been lost
EEPROM fault	EEPROM Fault	EEPROM fault	Hardware failure

See [Diagnostics Display](#) in Chapter 3 for more information on the PM335 PRO built-in diagnostics.

	A		M
Accuracy, 188		Modbus, 133	
Active energy, 188			N
Active power, 188		notification, 91	
analog outputs, 33, 35, 93, 102, 103, 189			O
Apparent energy, 188		Open Delta, 29, 30, 31, 94	
Apparent power, 188			P
	B	PAS, 75	
Broken Delta, 29, 32, 94		password, 73, 81	
	C	power, 3, 4, 24	
communication, 77		power source, 3, 4, 24	
CT Primary Current, 93		Power Source, 27	
	D	PT Ratio, 93, 203	
Delta, 29		Pulse LED, 71	
demand, 18			R
digital inputs, 98, 99		Reactive energy, 188	
display, 57		Reactive power, 188	
DNP3, 134		relay outputs, 33, 34, 100, 101	
	E		T
Ethernet, 38, 39, 75, 77, 78, 85, 86, 186		terminals, 3, 4, 24	
	G	test mode, 71, 94, 96	
GPRS, 40, 87, 88, 146		Total Demand Distortion, 188	
	I	Total Harmonic Distortion, 188	
inputs, 18			W
	L	Wiring Mode, 29, 30, 31, 32, 93, 94	
Low Resolution Option, 60		Wye, 29, 30, 31, 94	